

Linear Luminaire with LED

Series EXLUX 6002/1 Version IIB+H2

www.stahl.de



16707E00

- > For use in hazardous areas with gas group IIB+H₂
- > Latest LED technology with a high luminous efficacy and a long service life
- > As pendant light fitting or pole mounted light fitting
- > Central locking

E2



The luminaires with LED Series **EXLUX 6002** are suitable for general lighting of indoor and outdoor areas. The luminaires with LED were designed for 1 to 1 replacing of luminaires with fluorescent lamps. An equivalent luminous flux by lower energy consumption ensures an increase in efficiency of the lighting system.

Zone	ATEX / IECEx					
	0	1	2	20	21	22
For use in		x	x		x	x

Explosion Protection	
Global (IECEx)	
Gas and dust	IECEx IBE 14.0035 Ex db eb op is IIB+H ₂ T4 Gb Ex tb op is IIIC T100°C Db
Europe (ATEX)	
Gas and dust	IBExU 14ATEX1088 Ⓢ II 2 G Ex db eb op is IIB+H ₂ T4 Gb Ⓢ II 2 D Ex tb op is IIIC T100°C Db
Certifications and certificates	
Certificates	IECEx, ATEX, India (PESO), Kazakhstan (TR), Russia (TR), Belarus (TR)

WebCode 6002B

Linear Luminaire with LED

Series EXLUX 6002/1 Version IIB+H2

Selection Table

Version	Colour temperature	CRI	Length mm	Power consumption	Cable entry	Order number	Weight
							kg
EXLUX 6002 Gasgroup IIB+H2	5,000 K	≥ 80	700	28 W	3x M25 Plastic	6002/1182-5400-5131-0	4.300
					3x M20 Metal	6002/1182-5400-5232-0	4.300
			1310	52 W	3x M25 Plastic	6002/1284-5400-5131-0	6.600
					3x M20 Metal	6002/1284-5400-5232-0	6.600
	5,700 K	≥ 70	700	28 W	3x M25 Plastic	6002/1182-5400-5131-1	4.300
					3x M20 Metal	6002/1182-5400-5232-1	4.300
			1310	52 W	3x M25 Plastic	6002/1284-5400-5131-1	6.600
					3x M20 Metal	6002/1284-5400-5232-1	6.600

Note
The light fittings are delivered without mounting material.
These accessories must be ordered separately!

Technical Data

Electrical data

Control gear

AC: 110 V to 240 V ±10%; 50 to 60 Hz
DC: 110 V to 250 V ±10%

	6002/1.2-....-.....-		6002/2.4-....-.....-	
Power consumption [W]	28		52	
Voltage [V]	230	110	230	110
Frequency [Hz]	50	60	50	60
Power factor	> 0.90	> 0.99	> 0.95	> 0.99
THD [%]	< 8	< 12	< 6	< 6

Inrush current

Optionally available with DALI interface in accordance with IEC 62386-207:2009-08

$I_{peak} = 51 \text{ A}$; $\Delta t = 127 \mu\text{s}$

maximum number of luminaires per miniature circuit breaker at 230 V:

Type	10 A	16 A	20 A	25 A
B	8	13	16	20
C	13	22	27	34
K	27	44	55	69

Linear Luminaire with LED

Series EXLUX 6002/1 Version IIB+H2

Technical Data

Luminous characteristics

	6002/1.2-...-0	6002/2.4-...-0	6002/1.2-...-1	6002/2.4-...-1
Power consumption [W]	28	52	28	52
Colour rendering [CRI]	≥ 80	≥ 80	≥ 70	≥ 70
Colour temperature [K]	5,000	5,000	5,700	5,700
without diffuser				
Luminous flux [lm]	2,850	5,700	3,150	6,300
Luminaire efficacy [lm/W]	102	110	113	121
with diffuser				
Luminous flux [lm]	2,350	4,700	2,600	5,200
Luminaire efficacy [lm/W]	84	90	93	100

Values apply to $T_a = +25\text{ °C}$.
 Luminous flux decrease
 • at $T_a = +60\text{ °C}$ to $\geq 70\%$ of the nominal value.
 • during DC operation to 50%.

Ambient conditions

Operating temperature range	-40 ... +60 °C luminaires without through wiring -40 ... +60 °C luminaires with through wiring; $I_N \leq 10\text{ A}$ -40 ... +50 °C luminaires with through wiring; $I_N \leq 16\text{ A}$
Storage	-40 ... +75 °C

Service life

Service life	$T_a \leq 25\text{ °C}$	$T_a \leq 45\text{ °C}$	$T_a \leq 60\text{ °C}$
L70B10C10	100,000 h	90,000 h	50,000 h

$L_x B_y C_z$
 At the end of the service life:
 • Luminous flux decrease to "x" percent
 • up to "y" percent of all luminaires fall below "x"
 • up to "z" percent of all luminaires break down completely

Mechanical data

Degree of protection	IP66 / IP67 (IEC 60598)
Protection class	I (with internal PE connection)
Impact strength (IK code)	IK10 (IEC 62262)
Material	
Enclosure	
Material	Polyester resin, glass fibre-reinforced
Colour	colour grey, similar to RAL 7035
Seal	Silicone foam gasket in the lamp cover
Translucent cover	Polycarbonate
Luminaire locking	Central locking which can be opened/closed using a socket key M8 / wrench size 13, hinged lamp cover

Linear Luminaire with LED

Series EXLUX 6002/1 Version IIB+H2

Technical Data

Mounting / Installation

Cable glands	<p>Standard luminaire</p> <p>Plastic: 2 x M25 x 1.5 cable glands 8161 and 2 x M25 x 1.5 stopping plugs 8290 (enclosed)</p> <p>Metal: 2 x metal plates M20 x 1.5 connected by means of PE for metal cable entries Attention: cable entries must be ordered separately</p> <p>Special: max. 4 bores for M20, M25, NPSM ½" max. 2 bores for NPT ¾"</p> <p>Metal cable glands: M20 x 1.5, M25 x 1.5; earthing of the metal cable entries by means of metal plates</p>
Connection	<p>Standard: Cage clamp terminals 5-pole: L1, L2, L3, N, PE Clamping range: 1 x 0.75 to 4 mm² (solid / finely stranded) (2 free clamping units per pole available)</p> <p>Special version: Terminal block with cover 5-pole: L1, L2, L3, N, PE Clamping range: 2 x 0.75 to 6 mm² (solid); 2 x 0.75 to 4 mm² (finely and extra finely stranded)</p> <p>Luminaire with DALI: Cage clamp terminals 8-pole: L1, L2, L3, N, PE, D1, D2 Clamping range: 1 x 0.75 to 4 mm² (solid / finely stranded) (2 free clamping units per pole available)</p>
Through wiring	<p>Standard luminaire with Light fittings are equipped with internal through wiring. Inlet and outgoing leads can be connected to the opposite sides. Terminals: see tech. data Wiring cross section of the supply line connection: 2.5 mm² for max. 16 A</p> <p>Optional without On the connection side, there are 2 M25 x 1.5 bores for cable entries for inlet and outgoing wiring of the connection line (inlet and outgoing leads on one side).</p>
Assembly	<p>Standard luminaire</p> <p>Standard: 2 x M8 insert nuts in the enclosure</p> <p>Special: Mounting grooves in the enclosure for use of fastening and ceiling rails for variable luminaire mounting (variable mounting distances for luminaires L = 700 mm: 320 ... 480 mm; L = 1310 mm; 670 ... 930 mm)</p>

Linear Luminaire with LED

Series EXLUX 6002/1 Version IIB+H2



E2

Light Distribution Curves

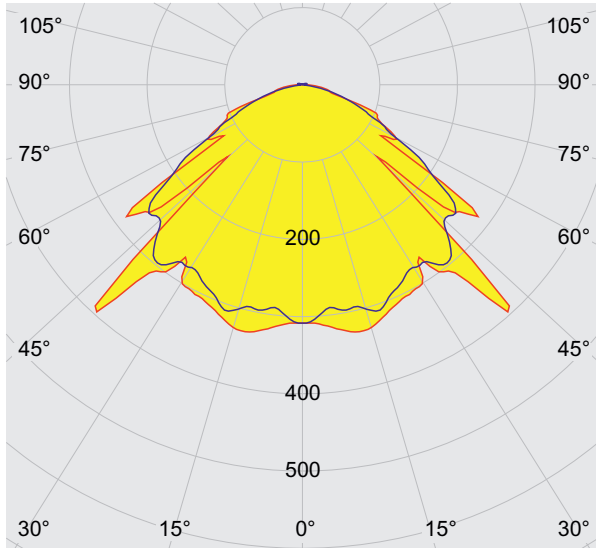

cd/klm 100%
 — C0 - C180 — C90 - C270

16683E00

28 W without diffusor

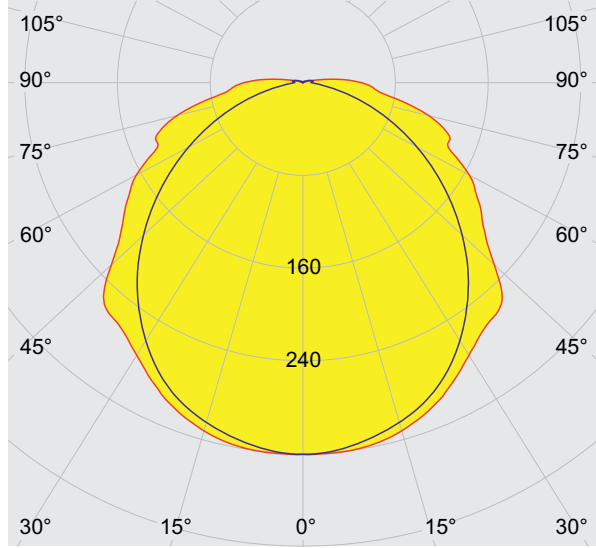

cd/klm 100%
 — C0 - C180 — C90 - C270

16723E00

28 W with diffusor

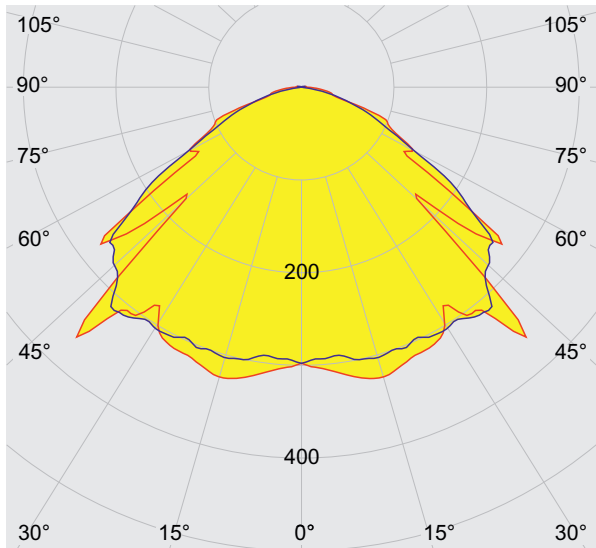

cd/klm 100%
 — C0 - C180 — C90 - C270

16724E00

52 W without diffusor

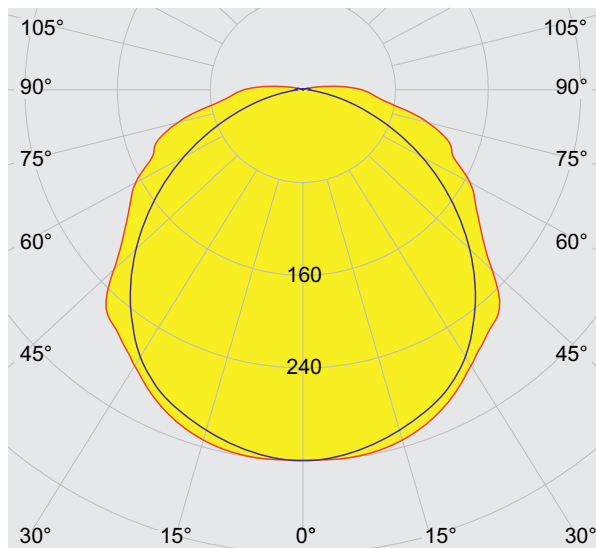

cd/klm 100%
 — C0 - C180 — C90 - C270





16725E00

52 W with diffusor

Linear Luminaire with LED

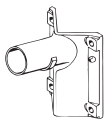
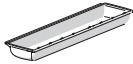
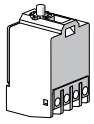
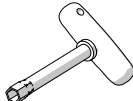
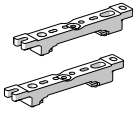
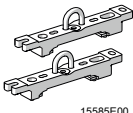
Series EXLUX 6002/1 Version IIB+H2

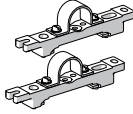
Accessories and Spare Parts

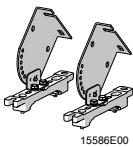
Designation	Figure	Description	Art. no.	Weight kg	
Bracket for wall mounting with tube	 05460E00	for side entry lamp; with tube, length 400 mm, \varnothing 42 mm	108947	2.480	
Translucent cover		for luminaire L=700	222427	0.639	
		for luminaire L=1310	222428	1.149	
		for luminaire L=700 (resistant to aromatic substances)	256534	0.639	
		for luminaire L=1310 (resistant to aromatic substances)	256535	1.149	
Switch	 10809E00	Switching element 8080/1-3-L, 2 normally closed contacts	132527	0.026	
Socket key	 15507E00	M8 / wrench size 13; to open/close the central locking	222430	0.210	
Mounting rail	 15584E00	for a variable mounting distance	1 pair	222826	0.300
Mounting bracket	 15585E00	mounting clamp mounted on a mounting rail for a variable mounting distance	1 pair	222456	0.400
Pole mounting sleeve	 16985E00	for the subsequent mounting on lights 18 W and 36 W, completely with assembly parts	227512	3.200	
Pipe clamp	 15583E00	R 1 1/2"	222459	1.200	
		R 1 1/4"	222458	0.900	
		R 2"	222460	0.750	
		with mounting rail for a variable mounting distance; Material: stainless steel	1 pair		
Ring bolt	 05378E00	M8, direct mounting in insert nuts, 1 pair	115736	0.112	
Ceiling and wall-mounting bracket	 15586E00	mounted on a mounting rail for a variable mounting distance; Material: stainless steel Lamp can be swiveled in steps of 15°	1 pair	222827	1.200

Linear Luminaire with LED

Series EXLUX 6002/1 Version IIB+H2



Dimensional Drawings (All Dimensions in mm [inches]) - Subject to Alterations

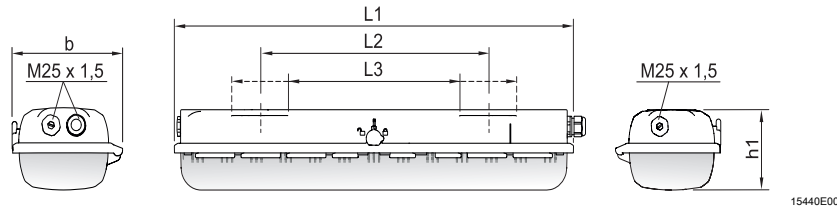

Dimensions	Luminaire	
	28 W	52 W
L1	700 [27.56]	1310 [51.57]
L2 ¹⁾	400 [15.75]	800 [31.50]
L3 ²⁾	320 ... 480 [12.60 ... 18.90]	670 ... 930 [26.38 ... 36.61]
b	184 [7.24]	184 [7.24]
h1	125 [4.92]	125 [4.92]

¹⁾ fixed mounting distance ²⁾ variable mounting distance

EXLUX 6002 Standard luminaire

Dimensional drawings for assembly parts and accessories (all dimensions in mm [inches]) – Subject to alterations

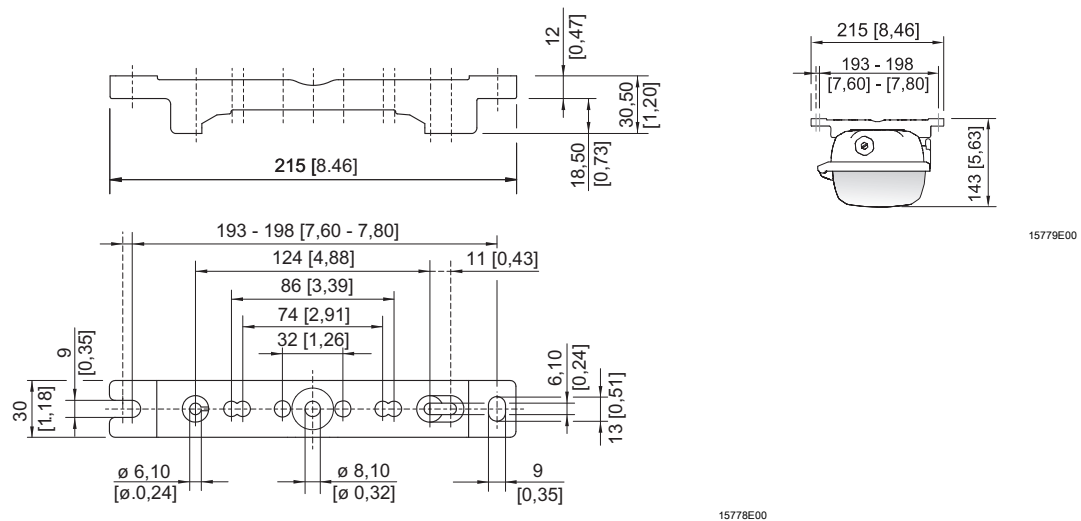

Mounting rail

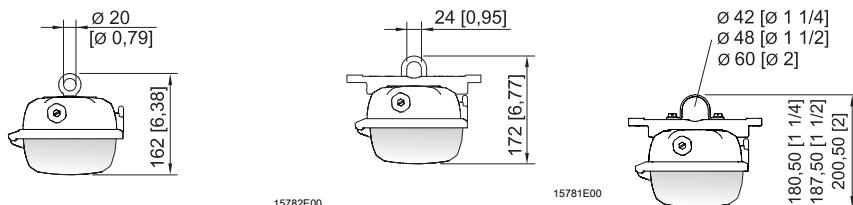

Ring bolt fitted in insert nut of the luminaire

Mounting bracket fitted in mounting rail

Pipe clamp fitted in mounting rail

Linear Luminaire with LED

Series EXLUX 6002/1 Version IIB+H2

Dimensional drawings for assembly parts and accessories (all dimensions in mm [inches]) – Subject to alterations

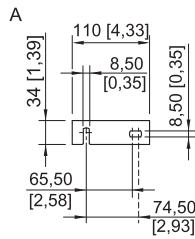
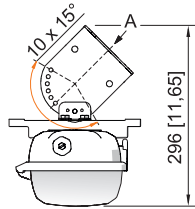

15780E00

Wall mounting bracket fitted in mounting rail

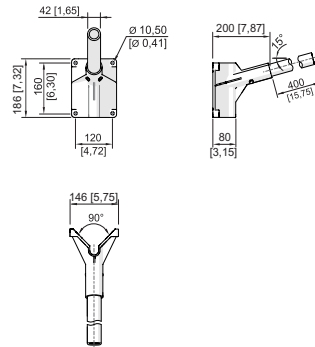

03257E00

Bracket for wall mounting with pipe section

We reserve the right to make alterations to the technical data, dimensions, weights, designs and products available without notice. The illustrations cannot be considered binding.