

Operating Instruction
for
Universal Indicating Unit
Norm signals 0/4-20 mA, 0-10 VDC

Model: ADI-1V... 96x96 mm



Identification

Options – break-down ordering code:

	A	D	I-	1	V	0	0	0	2	0	0
Standard type ADI											
Bargraph and Digital display, red Bargraph 55 points 270°, digital display 5-digit, 14 mm				1							
Type of display Voltage-/current input 0-10 VDC / 0/4-20 mA					V						
Power supply 100-240 VAC +/- 10% (50-60Hz) / DC 10-40 VDC / 18-30 VAC 50/60 Hz						0					
							3				
Analogue output without 0-10 VDC, 0/4-20 mA, 16 bit reversible								0			
									4		
Sensor supply without 5 VDC / 20 mA 12 VDC / 50 mA, incl. digital input 24 VDC / 50 mA, incl. digital input											
								0			
								U			
								V			
								W			
Setpoints 2 relay outputs											
										2	
Housing Panel mounting housing Field housing Field housing with wall mounting finally rotatable Field housing with pipe mounting											
											0
											F
											S
											R
Special without Special please specify in clear text											
											0
											Y

Contents

1. Brief description	5
2. Assembly	6
3. Electrical connection	7
4. Description of function and operation	10
5. Setting up the device	12
5.1. Switching on	12
5.2. Standard parameterisation (flat operation level)	12
Value assignment for the triggering of the signal input of the digital display and bargraph display	
5.3. Programming interlock „RUN“	16
Activation/Deactivation of the programming interlock or change into professional operation level respectively back into flat operation level	
5.4. Extended parameterisation (professional operation level)	17
5.4.1. Signal input parameters „INP“	17
Value assignment for the triggering of the signal input incl. linearisation of the digital display and the bargraph display	
5.4.2. General device parameters "FCT"	20
"FCT" Superior device functions like HOLD, TARA, min/max permanent, setpoint value function / nominal value function, averaging, brightness control, as well as the control of the digital input and keyboard layout	
5.4.3. Bargraph functions „bar“	24
Assignment of the bargraph to superior functions like min/max, totaliser, HOLD or sliding averaging	
5.4.4. Safesafety parameters „Cod“	26
Assignment of user and master code for locking respectively for access to defined parameters like e.g. analog output and alarms, etc.	
5.4.5. Analog output parameters „Out“	27
Analog output functions	
5.4.6. Relay functions „rel“	29
Parameters for the definition of the setpoints	
5.4.7. Alarm parameters „AL1...AL4“	31
Actuator and dependencies of the alarms	
5.4.8. Totaliser (volume metering) „tot“	33
Parameters for the calculation of the sum function	
6. Reset to factory settings	34
Reset parameters to delivery state	
7. Alarms / Relay	35
Functional principle of the switching outputs	
8. Sensor alignment	36
Diagram of functional sequences for sensors with existing adjustable resistor	
9. Technical data	37
10. Safety advices	39
11. Error elimination	40
12. Disposal	41
13. EU Declaration of Conformance	42



The instruction manuals on our website www.kobold.com are always for currently manufactured version of our products. Due to technical changes, the instruction manuals available online may not always correspond to the product version you have purchased. If you need an instruction manual that corresponds to the purchased product version, you can request it from us free of charge by email (info.de@kobold.com) in PDF format, specifying the relevant invoice number and serial number. If you wish, the operating instructions can also be sent to you by post in paper form against an applicable postage fee.

Manufactured and sold by:

Kobold Messring GmbH
Nordring 22-24
D-65719 Hofheim
Tel.: +49(0)6192-2990
Fax: +49(0)6192-23398
E-Mail: info.de@kobold.com
Internet: www.kobold.com

1. Brief description

The panel meter instrument **ADI-1V** is a 5-digit digital display with a 55 points bargraph display and two galvanic insulated setpoints; designed for direct current/direct voltage signals. The configuration happens via four keys at the front. The integrated programming interlock prevents unrequested changes of parameters and can be unlocked again with an individual code. Optional the following functions are available: a supply for the sensor, a digital input for triggering of Hold (Tara), two analog outputs and interfaces for further evaluating in the unit. The electrical connection is done via plug-in terminals on the back side.

Selectable functions like e.g. the recall of the min/max-value, an averaging of the measuring signals, a nominal presetting or setpoint presetting, a direct threshold value regulation during operation mode and further measuring setpoints for linearisation, complete the modern device concept.

Technical features:

- red display of -19999...99999 digits
- red 55 points bargraph
- adjustable bar or dot operation or operation with permanent display of center point
- min/max memory
- 30 additional adjustable setpoints
- display flashing at threshold value exceedance/undercut
- zero-key for triggering of HOLD, TARA
- permanent min/max-value recording
- volume metering (totalisator)
- mathematical functions like reciprocal value, square root, squaring or rounding
- setpoint generator
- sliding averaging
- brightness control
- programming interlock via access code
- protection class IP65 at the front
- plug-in screw terminal
- 2 relay outputs (changer)
- optional: sensor supply and digital input
- optional: analog output

2.1 Mounting panel housing

Please read the *Safety advice* on page 37 before installation and keep this user manual for future reference.

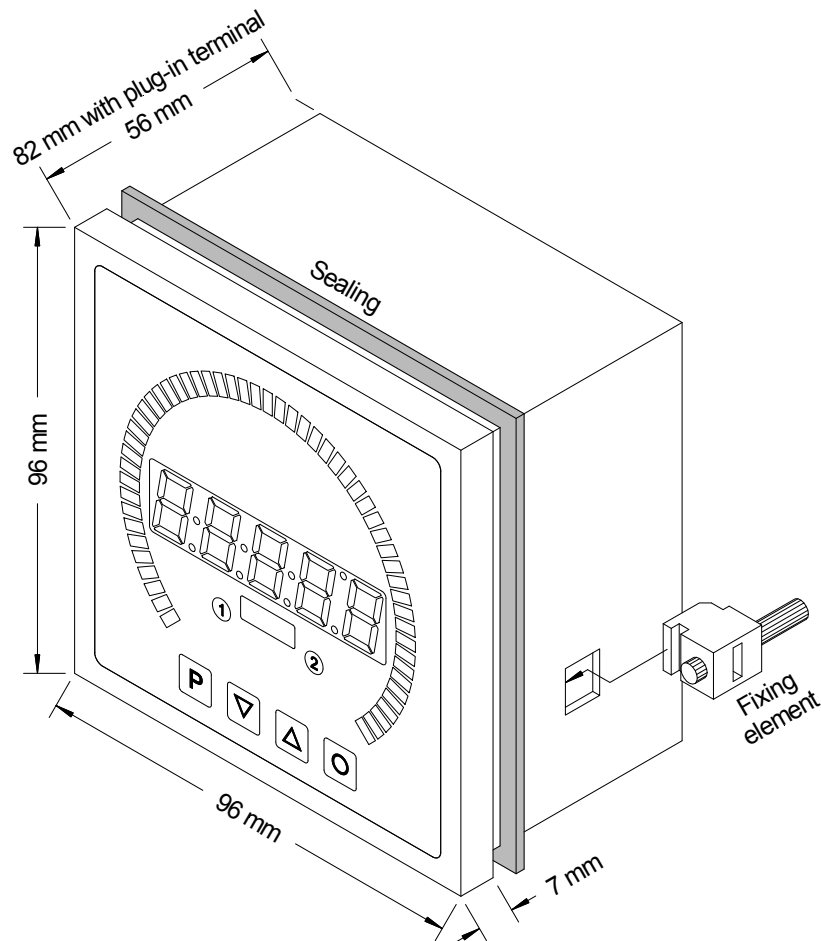

1. After removing the fixing elements, insert the device.
2. Check the seal to make sure it fits securely.
3. Click the fixing elements back into place and tighten the clamping screws by hand. Then use a screwdriver to tighten them another half a turn.

CAUTION! The torque should not exceed 0.1 Nm!

Please state you favorite dimension symbol in your order, they can not be exchanged afterwards!

2.2 Mounting field housing

For the assembling of ADI-1 field housing please use the M4 screws. Optionally the housing can be delivered with wall mounting or pipe mounting. For the electrical connection please pull the housing lead back.

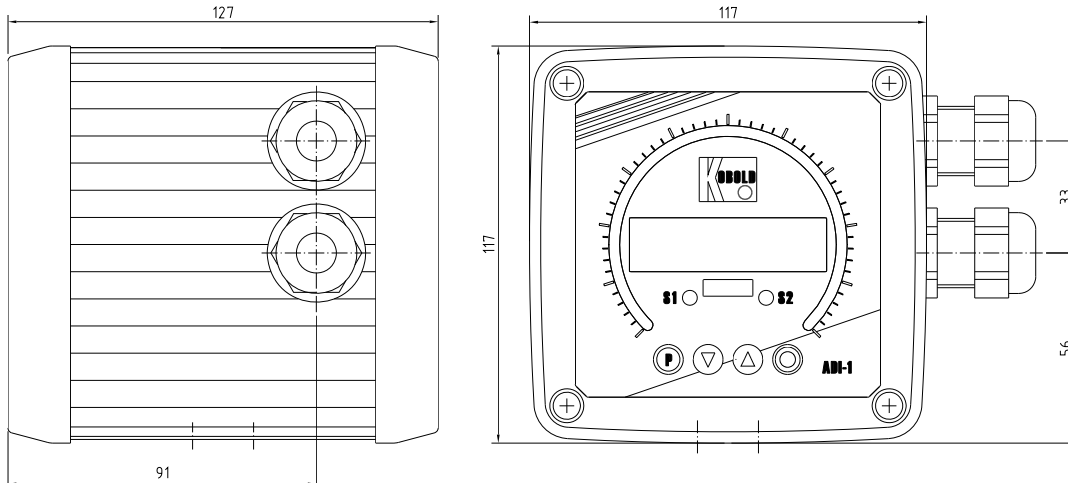

3. Electrical connection

Model ADI-1V000200 with supply of 100-240 VAC
 Model ADI-1V300200 with supply of 10-40 VDC

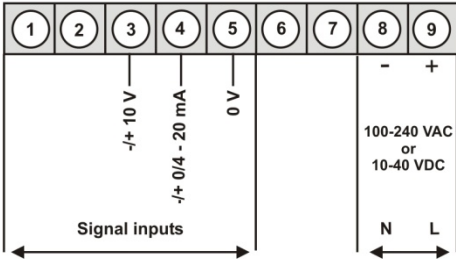

Options:

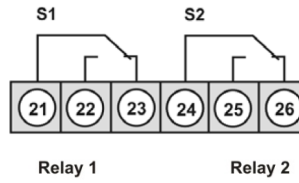
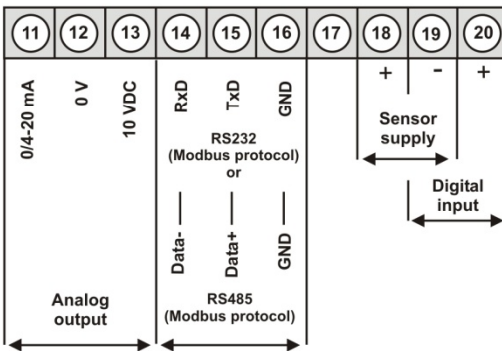

Connection examples

ADI-1V devices with current input / voltage input

ADI-1V devices in combination with a 2-wire-sensor 4-20 mA

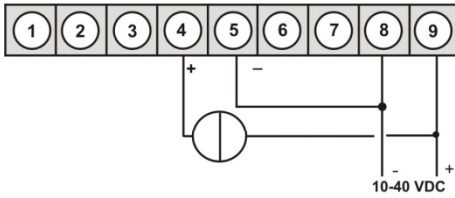

ADI-1V devices in combination with a 3-wire-sensor 0/4-20 mA

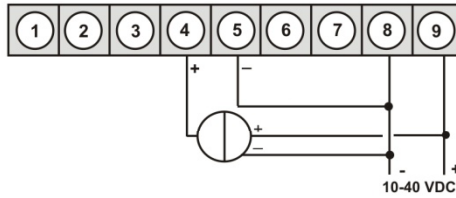

ADI-1V devices in combination with a 3-wire-sensor 0-10 V

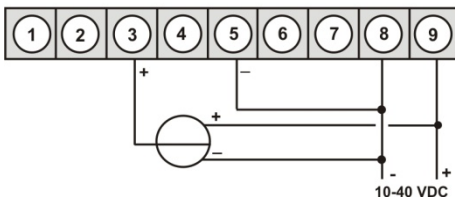

ADI-1V -devices with current input / voltage input and sensor supply

2-wire-sensor 4-20 mA

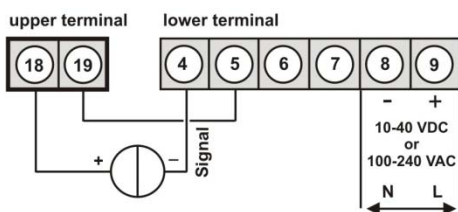

3-wire-sensor 0-20 mA

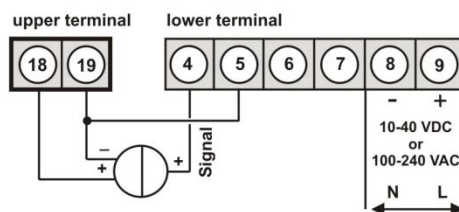

3-wire-sensor 0-10 V

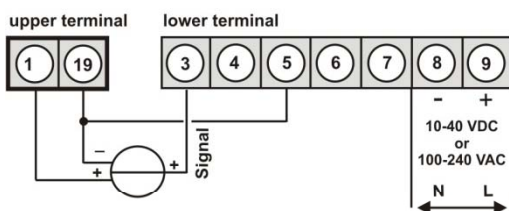

4. Description of function and operation

Operation

The operation is divided into three different levels.

Menu level (delivery status)













This level is for the standard settings of the device. Only menu items which are sufficient to set the device into operation are displayed. To get into the professional level, run through the menu level and parameterise **“prof”** under menu item **RUN**.

Menu group level (complete function volume)

Suited for complex applications as e.g. linkage of alarms, setpoint treatment, totaliser function etc. In this level function groups which allow an extended parameterisation off the standard settings are available. To leave the menu group level, run through this level and parameterise **„uloc„** under menu item **RUN**.

Parameterisation level:

Parameter deposited in the menu item can here be parameterised. Functions, that can be changed or adjusted, are always signalled by a flashing of the display. Settings that are made in the parameterisation level are confirmed with **[P]** and thus saved. By pressing the **„[O]-key“** it leads to a break-off of the value input and to a change into the menu level. All adjustments are saved automatically by the device and changes into operating mode, if no further key operation is done within the next 10 seconds.

Level	Key	Description
Menu-level		Change to parameterisation level and deposited values.
	 	Keys for up and down navigation in the menu level.
		Change into operation mode.
Parameterisation-level		To confirm the changes made at the parameterisation level.
	 	Adjustment of the value / the setting.
		Change into menu level or break-off in value input.
Menu-group-level		Change to menu level.
	 	Keys for up and down navigation in the menu group level.
		Change into operation mode or back into menu level.

Function chart:

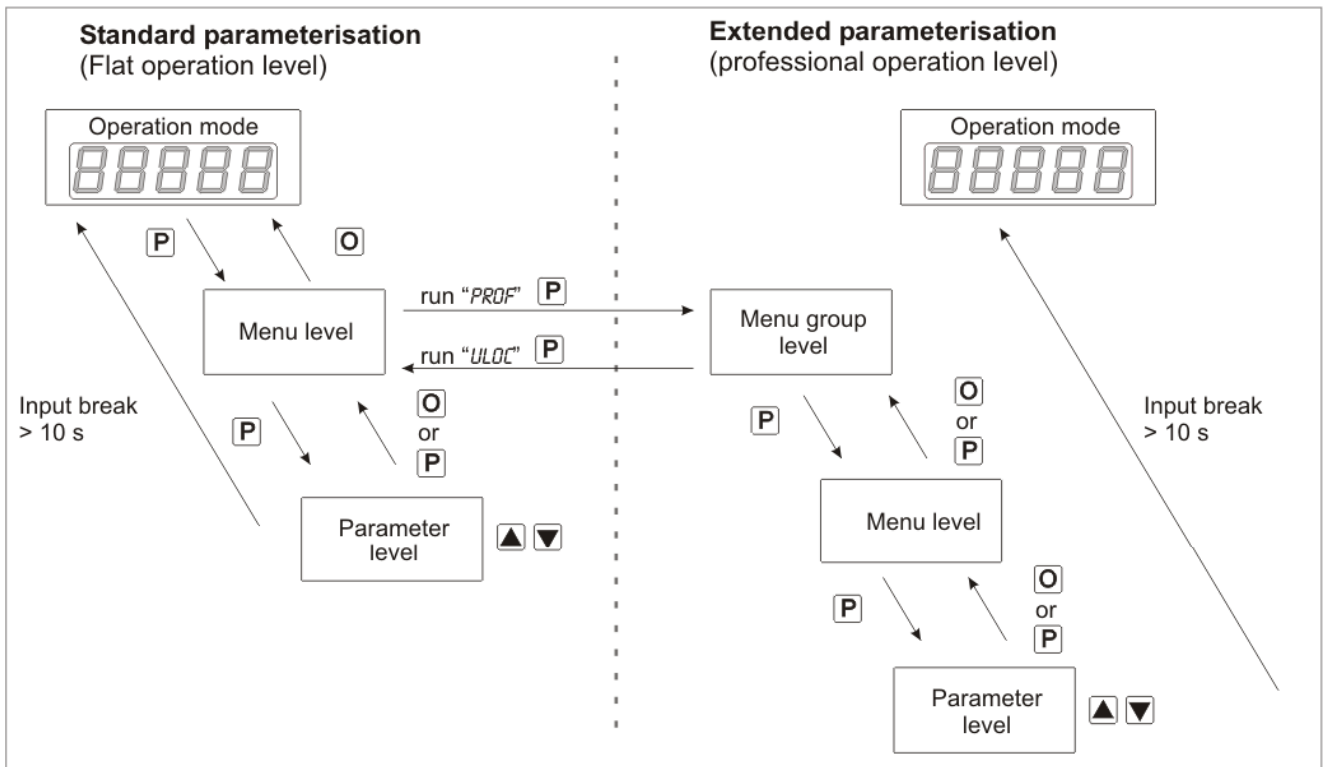

Underline:

- P** Takeover
- O** Stop
- ▲** Value selection (+)
- ▼** Value selection (-)

5. Setting up the device

5.1. Switching on

Once the installation is complete, you can start the device by applying the voltage supply. Before, check once again that all electrical connections are correct.









Starting sequence

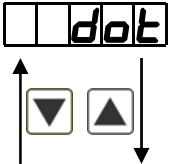

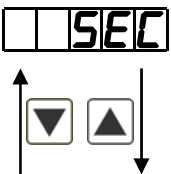
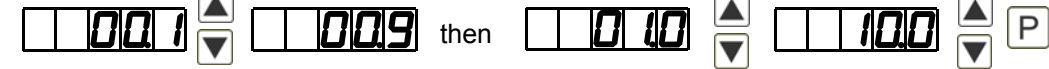
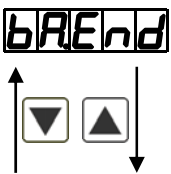
For 1 second during the switching-on process, the segment test (8 8 8 8 8) is displayed followed by an indication of the software type and, after that, also for 1 second the software version. After the starting sequence, the device switches to operation/display mode.

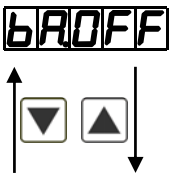
5.2. Standard parameterisation: (Flat operation level)

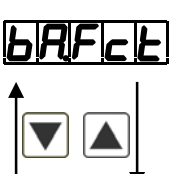



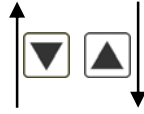
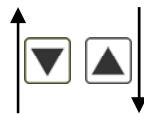

To parameterise the display, press the [P] key in operating mode for 1 second. The display then changes to the menu level with the first menu item *TYPE*.

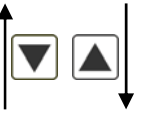
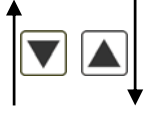
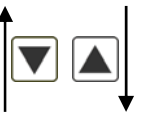
Menu level	Parameterisation level
	<p>Selection of the input signal, TYPE: Default: sens.u</p> <p> </p> <p>Available as measuring input options are 0-20 mA, 4-20 mA or 0-10 VDC signals as works calibration (without application of the sensor signal) and SENSU (voltage) or SENSA (current) as sensor calibration (with the sensor applied). Confirm the selection with [P] and the display switches back to menu level.</p>
	<p>Setting the end value of the measuring range, END: Default: 10000</p> <p> </p> <p>Set the end value from the smallest to the highest digit with [▲] [▼] and confirm each digit with [P]. A minus sign can only be parameterized on the highest value digit. After the last digit, the display switches back to the menu level. If Sens was selected as input option, you can only select between noca and cal. With noca, only the previously set display value is taken over, and with cal, the device takes over both the display value and the analogue input value.</p>
	<p>Setting the start/offset value of the measuring range, offs: Default: 0</p> <p> </p> <p>Enter the start/offset value from the smallest to the highest digit with [▲] [▼] and confirm each digit with [P]. After the last digit the display switches back to the menu level. If Sens was selected as input option, you can only select between noca and cal. With noca, only the previously set display value is taken over, and with cal, the device takes over both the display value and the analogue input value.</p>

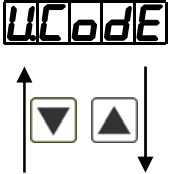
Menu level	Parameterisation level
	<p>Setting the decimal point, <i>dot</i>: Default: 0</p>  <p>The decimal point on the display can be moved with [▲] [▼] and confirmed with [P]. The display then switches back to the menu level again.</p>
	<p>Setting up the display time, <i>SEC</i>: Default: 1.0</p>  <p>The display time is set with [▲] [▼]. The display moves up in increments of 0.1 sec up to 1 sec and in increments of 1.0 sec up to 10.0 sec. Confirm the selection by pressing the [P] button. The display then switches back to the menu level again.</p>
	<p>Setting up the final value of the bargraph, <i>ba.ENd</i>: Default: 10000</p>  <p>Set the final value from the smallest to the highest digit with [▲] [▼] and confirm each digit with [P]. A minus sign can only be parameterised on the highest value digit. After the last digit, the display switches back to the menu level.</p>
	<p>Setting up the initial value of the bargraph, <i>ba.off</i>: Default: 0</p>  <p>Set the initial value from the smallest to the highest digit with [▲] [▼] and confirm each digit with [P]. A minus sign can only be parameterised on the highest value digit. After the last digit, the display switches back to the menu level.</p>
	<p>Selection of the bargraph functions, <i>ba.fct</i>: Default: <i>bar.fo</i></p>  <p>The bargraph can be displayed with the following possibilities: bars from left to right (top to bottom) or bars from right to left (bottom to top), bars from the middle, a dot display of the bargraph or a dot display with a permanently displayed midpoint. Confirm the selection by pressing the [P] button. The display then switches back to the menu level again.</p>

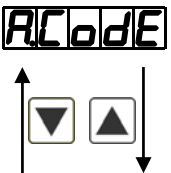
Menu level	Parameterisation level
	<p>Selection of analog output, <i>Out.rA</i>: Default: 4-20</p> <p>Out.rA P 0-10 ▲ ▼ 0-20 ▲ ▼ 4-20 ▲ ▼ P</p> <p>Three output signals are available: 0-10 VDC, 0-20 mA and 4-20 mA, with this function, the demanded signal is selected.</p>
	<p>Setting up the final value of the analog output, <i>Out.En</i>: Default: 10000</p> <p>Out.En P 8 P 8 P 8 P 8 P 8 ▲ ▼ P</p> <p>The final value is adjusted from the smallest digit to the highest digit with [▲] [▼] and digit by digit confirmed with [P]. A minus sign can only be parameterised on the highest digit. After the last digit, the device changes back into menu level.</p>
	<p>Setting up the initial value of the analog output, <i>Out.OF</i>: Default: 00000</p> <p>Out.OF P 8 P 8 P 8 P 8 P 8 ▲ ▼ P</p> <p>The final value is adjusted from the smallest digit to the highest digit with [▲] [▼] and digit by digit confirmed with [P]. A minus sign can only be parameterised on the highest digit. After the last digit, the device changes back into menu level.</p>
	<p>Threshold values / Limits, <i>LI-1</i>: Default: 2000</p> <p>LI-1 P 0 P 0 P 0 P 0 P 0 ▲ ▼ P</p> <p>This value defines the threshold, that activates/deactivates an alarm.</p>
	<p>Hysteresis for limit values, <i>HY-1</i>: Default: 00000</p> <p>HY-1 P 0 P 0 P 0 P 0 P 0 ▲ ▼ P</p> <p>The delayed reaction of the alarm is the difference to the threshold value, which is defined by the hysteresis.</p>

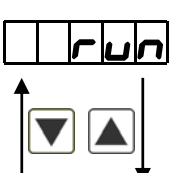
Menu level	Parameterisation level
	<p>Function for threshold value undercut /exceedance, Fu-1: Default: <i>high</i></p> <p>Fu-1 P H I G H ▲ ▼ L o w w ▲ ▼ P</p> <p>A limit value undercut is selected with <i>Low</i> (for LOW = lower limit value), a limit value exceedance with <i>High</i> (for HIGH = higher limit value). If e.g. limit value 1 is on a threshold level of 100 and allocated with function <i>High</i>, an alarm is activated by reaching of the threshold level. If the threshold value was allocated to <i>Low</i>, an alarm will be activated by undercutting the threshold value, as long as the hysteresis is zero.</p>
	<p>Threshold values / Limits, LI-2: Default: 2000</p> <p>LI-2 P 0 P 0 P 0 P 0 P 0 P 0 ▲ ▼ P</p> <p>This value defines the threshold, that activates/deactivates an alarm.</p>
	<p>Hysteresis for limit values, HY-2: Default: 00000</p> <p>HY-2 P 0 P 0 P 0 P 0 P 0 P 0 ▲ ▼ P</p> <p>The delayed reaction of the alarm is the difference to the threshold value, which is defined by the hysteresis.</p>
	<p>Function for threshold value undercut /exceedance, Fu-2: Deault <i>high</i></p> <p>Fu-2 P H I G H ▲ ▼ L o w w ▲ ▼ P</p> <p>A limit value undercut is selected with <i>Low</i> (for LOW = lower limit value), a limit value exceedance with <i>High</i> (for HIGH = higher limit value). If e.g. limit value 1 is on a threshold level of 100 and allocated with function <i>High</i>, an alarm is activated by reaching of the threshold level. If the threshold value was allocated to <i>Low</i>, an alarm will be activated by undercutting the threshold value, as long as the hysteresis is zero.</p>







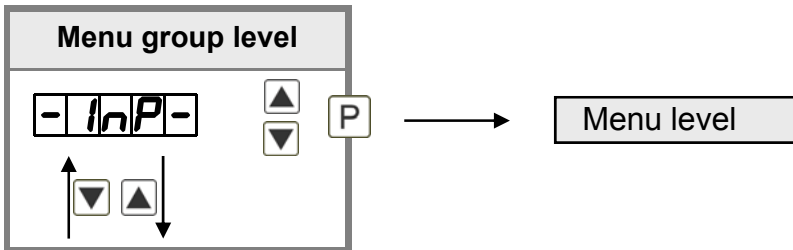





Menu level	Parameterisation level
	<p>User code (4-digit number-combination, free available), U.Code: Default: 0000</p>  <p>If this code was set (>0000), all parameters are locked for the user, if LOC has been selected before under menu item run. By pressing [P] for 3 seconds in operation mode, the display shows COde. The U.Code needs to be entered to get to the reduced number of parameter sets. The code has to be entered before each parameterisation, until the A.Code (Master code) unlocks all parameters again.</p>
	<p>Master code (4-digit number-combination, free available), A.Code: Default: 1234</p>  <p>All parameters can be unlocked with this code, after LOC has been activated under menu item run. By pressing [P] for 3 seconds in operation mode, the display shows COde and enables the user to reach all parameters by entering the A.codE. Under run the parameterisation can be activated permanently by selecting ULOC or ProF, thus at an anew pushing of [P] in operation mode, the code needs not to be entered again.</p>
<p>5.3. Programming interlock „run“</p>	
	<p>Activation / deactivation of the programming lock or completion of the standard parameterisation with change into menu group level (complete function range), run: Default: <i>uloc</i></p>  <p>With the navigation keys [▲] [▼], you can choose between the deactivated key lock Uloc (works setting) and the activated key lock Loc, or the change into the menu group level ProF. Confirm the selection with [P]. After this, the display confirms the settings with "- - - -", and automatically switches to operating mode. If Loc was selected, the keyboard is locked. To get back into the menu level, press [P] for 3 seconds in operating mode. Now enter the CODE (works setting 1 2 3 4) that appears using [▲] [▼] plus [P] to unlock the keyboard. FAIL appears if the input is wrong. To parameterise further functions ProF needs to be set. The device confirms this setting with „- - - -“, and changes automatically in operation mode. By pressing [P] for approx. 3 seconds in operation mode, the first menu group InP is shown in the display and thus confirms the change into the extended parameterisation. It stays activated as long as ULOC or LOC is entered in menu group RUN.</p>





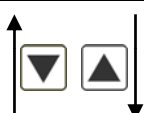

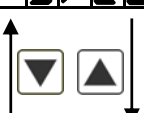

5.4. Extended parameterisation (professional operation level)

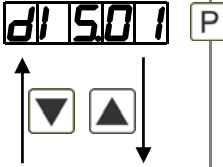
5.4.1. Signal input parameters

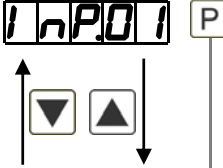

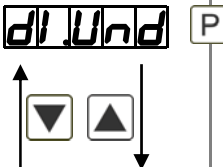
Menu level	Parameterisation level
	<p>Selection of the input signal, TYPE: Default: <i>sens.u</i></p> <p>There are several measuring input options: 0-20 mA, 4-20 mA or 0-10 VDC signals as works calibration (without application of the sensor signal) and SensU (voltage) or SENSA (current) as sensor calibration (with the sensor applied). Confirm the selection with [P] and the display switches back to menu level.</p>
	<p>Setting the end value of the measuring range, END: Default: <i>10000</i></p> <p>Set the end value from the smallest to the highest digit with [▲] [▼] and confirm each digit with [P]. A minus sign can only be parameterised on the highest value digit. After the last digit, the display switches back to the menu level. If Sens was selected as input option, you can only select between <i>noca</i> and <i>cal</i>. With <i>noca</i>, only the previously set display value is taken over, and with <i>cal</i>, the device takes over both the display value and the analogue input value.</p>
	<p>Setting up the start/offset value of the measuring range, offs: Default: <i>0</i></p> <p>Enter the start/offset value from the smallest to the highest digit with [▲] [▼] and confirm each digit with [P]. After the last digit the display switches back to the menu level. If Sens was selected as input option, you can only select between <i>noca</i> and <i>cal</i>. With <i>noca</i>, only the previously set display value is taken over, and with <i>cal</i>, the device takes over both the display value and the analogue input value.</p>
	<p>Setting the decimal point, dot: Default: <i>00</i></p> <p>The decimal point on the display can be moved with [▲] [▼] and confirmed with [P]. The display then switches back to the menu level again.</p>

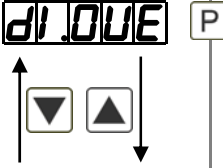

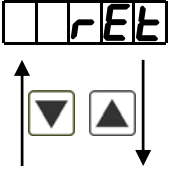



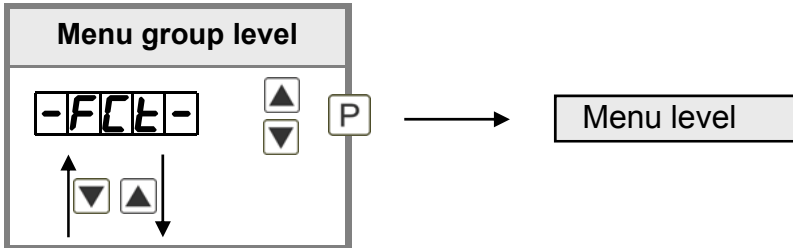

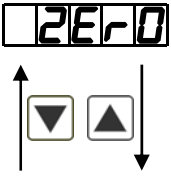

Menu level	Parameterisation level
	<p>Setting up the display time, SEC: Default: 1.0</p> <p>  </p> <p>The display time is set with [▲] [▼]. The display moves up in increments of 0.1 sec up to 1 sec and in increments of 1.0 sec up to 10.0 sec. Confirm the selection by pressing the [P] button. The display then switches back to the menu level again.</p>
	<p>Rescaling the measuring input values, EndA: Default: 10000</p> <p>  </p> <p>With this function, you can rescale the input value of e.g. 19.5 mA (works setting) without applying a measuring signal. If sensor calibration has been selected, these parameters are not available.</p>
	<p>Rescaling the measuring input values, OFFA: Default: 0</p> <p>  </p> <p>With this function, you can rescale the input value of e.g. 3.5 mA (works setting) without applying a measuring signal. If sensor calibration has been selected, these parameters are not available.</p>
	<p>Setting up the tare/offset value, tArA: Default: 0</p> <p>  </p> <p>The given value is added to the linearised value. In this way, the characteristic line can be shifted by the selected amount.</p>
	<p>Setting up the balance point, Adj.pt: Default: 08000</p> <p>  </p> <p>The balance point for the final value can be chosen from the measuring range by Sens.u with 0...10 V or Sens.A with 0...20 mA in %. The preset 80.000% result from the widespread detuning of the melt pressure sensors.</p>
	<p>Number of additional setpoints, SPCt: Default: 00</p> <p>  </p> <p>30 additional setpoints can be defined to the initial- and final value, so linear sensor values are not linearised. Only activated setpoint parameters are displayed.</p>

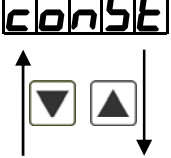

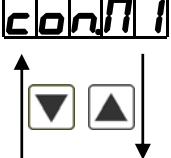
Menu level	Parameterisation level
	<p>Display values for setpoint, <i>dl.S.01 ... dl.S.30:</i></p>  <p>Under this parameter setpoints are defined according to their value. At the sensor calibration, like at Endwert/Offset, one is asked at the end if a calibration shall be activated.</p>
	<p>Analog values for setpoints, <i>lnP.01 ... lnP.30:</i></p>  <p>The setpoints are always set according to the selected input signal. The desired analog values can be freely parametrised in ascending order.</p>
	<p>Device undercut, <i>dl.Und:</i> Default: -i9999</p>  <p>With this function the device undercut (____) can be defined on a definite value. Exception is input type 4-20 mA, it already shows undercut at a signal <1 mA, so a sensor failure is marked.</p>
	<p>Display overflow, <i>dl.OUE:</i> Default: 99999</p>  <p>With this function the display overflow (----) can be defined on a definite value.</p>
	<p>Back to menu group level, <i>rEt:</i></p> <p>With [P] the selection is confirmed and the device changes into menu group level „-INP-“.</p>

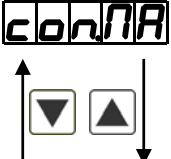
5.4.2. General device parameters



Menu level	Parameterisation level
	<p>Display time, <i>DISC</i>: Default: 01.0</p> <p> then </p> <p>The display is set up with [▲] [▼]. Thereby it switches up to 1 second in increments of 0.1 seconds and up to 10.0 seconds in increments of 1.0. With [P] the selection is confirmed and the device changes into menu level.</p>
	<p>Rounding of display values, <i>round</i>: Default: 00001</p> <p> </p> <p>This function is for instable display values, where the display value is changed in increments of 1, 5, 10 or 50. This does not affect the resolution of the optional outputs. With [P] the selection is confirmed and the device changes into menu level.</p>
	<p>Arithmetic, <i>Arth</i>: Default: no</p> <p> </p> <p style="text-align: center;"> Reciprocal Root extraction Square </p> <p>With this function the calculated value, not the measuring value, is shown in the display. With <i>no</i>, no calculation is deposited. With [P] the selection is confirmed and the device changes into menu level.</p>
	<p>Sliding average determination, <i>AVG</i>: Default: 10</p> <p> </p> <p>Here, the number of the meterings that need to be averaged is preset. The time of averaging results of the product of measuring time <i>SEC</i> and the averaged metering <i>AVG</i>. With the selection of <i>AVG</i> in the menu level <i>DISPL</i>, the result will be shown in the display and evaluated via the alarms.</p>

Menu level	Parameterisation level
	<p>Zero point slowdown, ZErO: Default: 00</p>  <p>At the zero point slowdown, a value range around the zero point can be preset, so the display shows a zero. If e.g. a 10 is set, the display would show a zero in the value range from -10 to +10; below continue with -11 and beyond with +11. The maximum adjustable range of value is 99.</p>
	<p>Definite constant value, const: Default: 0</p>  <p>The constant value can be evaluated via the alarms or via the analog output, like the current measurand. The decimal place cannot be changed for this value and is taken over by the current measurand. Like this a setpoint generator can be realised via the analog output by this value. Furthermore it can be used for calculating the difference. At this the constant value is subtracted from the current measurand and the difference is evaluated in the alerting or by the analog output. Thus regulations can be displayed quite easily.</p>
	<p>Minimum constant value, con.mi: Default: -j9999</p>  <p>The minimum constant value is adjusted from the smallest to the highest digit with the navigation keys [▲] [▼] and confirmed digit per digit with [P]. A minus sign can only be adjusted on the highest digit. After the last digit the display changes back into menu level.</p>
	<p>Maximum constant value, con.ma: Default: 99999</p>  <p>The maximum constant value is adjusted from the smallest to the highest digit with the navigation keys [▲] [▼] and confirmed digit per digit with [P]. A minus sign can only be adjusted on the highest digit. After the last digit the display changes back into menu level.</p>
	<p>Display, dISPL: Default: actua</p>  <p>With this function the current measuring value, Min-/Max value, totaliser value or the process-controlled Hold-value can be allocated to the display. With [P] the selection is confirmed and the device changes into menu level.</p>



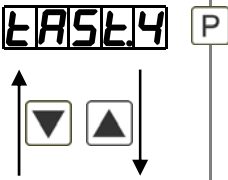
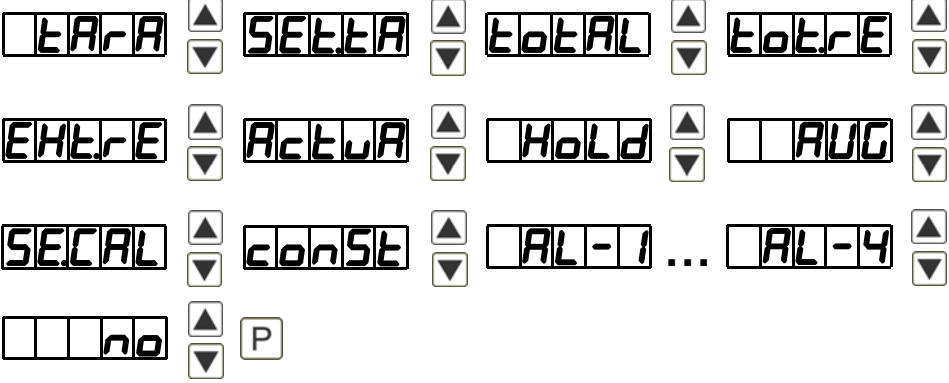
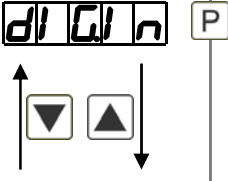
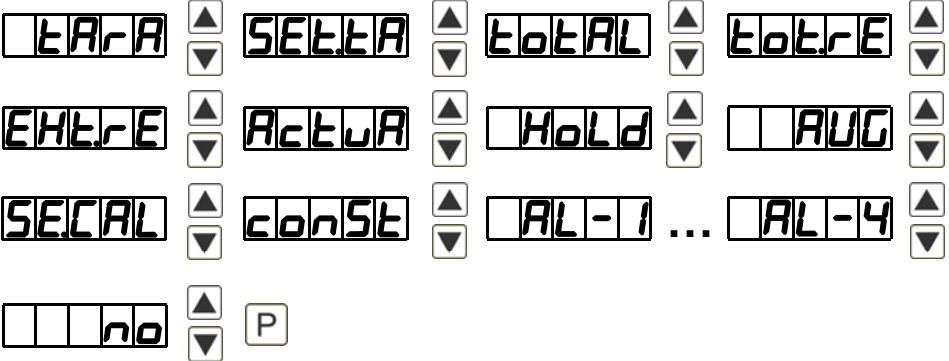
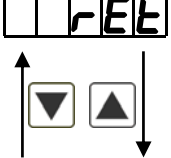

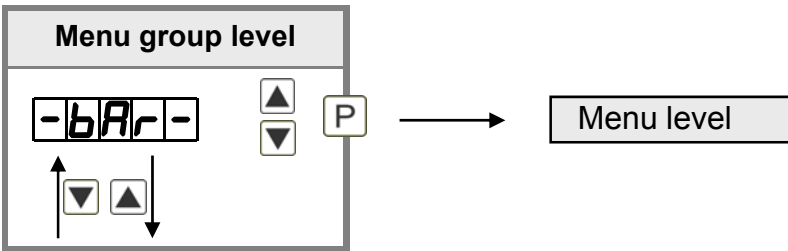

Menu level	Parameterisation level
	<p>Brightness control, <i>Light</i>: Default: 10</p> <p>L I G H T P 0 0 ▲ ▼ 1 5 ▲ ▼ P</p> <p>The brightness of the display can be adjusted in 16 levels from 00 = very dark to 15 = very bright via this parameter or alternatively via the navigation keys from the outside. During the start of the device, the level that is deposited under this parameter will always be used, even though the brightness has been changed via the navigation keys in the meantime.</p>
	<p>Display flashing, <i>FLASH</i>: Default: <i>no</i></p> <p>FLASH P n o ▲ ▼ AL-1 ▲ ▼ AL-2 ▲ ▼ AL 12 ▲ ▼</p> <p>AL-3 ▲ ▼ AL-4 ▲ ▼ AL.34 ▲ ▼ ALAL ▲ ▼ P</p> <p>A display flashing can be added as additional alarm function either to single or to a combination of off-limit condition. With <i>no</i>, no flashing is allocated.</p>
	<p>Assignment (deposit) of key functions, <i>tASt</i>: Default: <i>no</i></p> <p>t A S T P E H t r ▲ ▼ L I . 1 2 ▲ ▼ L I . 3 4 ▲ ▼ t A r A ▲ ▼</p> <p>S E t t A ▲ ▼ t o t A L ▲ ▼ t o t . r E ▲ ▼ E H t . r E ▲ ▼</p> <p>A c t u A ▲ ▼ L I G H T ▲ ▼ n o ▲ ▼ P</p> <p>For the operation mode, special functions can be deposited on the navigation keys [▲] [▼], in particular this function is made for devices in housing size 48x24 which do not have a 4th key ([O]-key). If the min-/max-memory is activated with <i>EHtr</i>, all measured min/max-values are safed during operation and can be recalled via the navigation keys. The values get lost by re-start of the device. If the threshold value correction <i>LI.12</i> or <i>LI.34</i> is choosen, the values of the threshold can be changed during operation without disturbing the operating procedure. With <i>tArA</i> the device is taret to zero and safed permanently as offset. The device confirms the correct taring by showing <i>oooo</i> in the display <i>Set.tA</i> switches into the offset value and can be changed via the navigation keys [▲] [▼]. Via <i>total</i> the current value of the totaliser can be displayed for approx.7 seconds, after this the device changes back on the parameterised display value. If <i>tot.rE</i> is deposited, the totaliser can be set back by pressing of the navigation keys [▲] [▼], the device acknowledges this with <i>oooo</i> in the display. The configuration of <i>EHt.rE</i> deletes the min/max-memory. Under <i>ActuA</i> the measurand is shown for approx. 7 seconds, after this the display returns to the parameterised display value. If <i>AbS.UA</i> (absolute value) was selected, the display shows the value that has been measured since voltage connection, without consideration of a previous taring. If <i>no</i> is selected, the navigation keys are without any function in the operation mode.</p>

Menu level	Parameterisation level
	<p data-bbox="352 324 758 392">Special function [O]-key, <i>tAst.4</i>: Default: <i>no</i></p> <div data-bbox="384 436 1337 817">  </div> <p data-bbox="352 840 1497 1288">For the operation mode, special functions can be deposited on the [O]-Taste. This function is activated by pressing the key. With <i>tArA</i> the device is set temporarily on a parameterised value. The device acknowledges the correct taring with <i>0000</i> in the display. <i>Set.tA</i> switches into the offset value and can be changed via the navigation keys [▲] [▼]. Via <i>totAL</i> the current value of the totaliser can be displayed for approx. 7 seconds, after this the device switches back on the parameterised display value. If <i>tot.rE</i> is deposited, the totaliser can be set back by pressing of the navigation keys [▲] [▼], the device acknowledges this with <i>0000</i> in the display. <i>EHt.rE</i> deletes the min/max-memory. If <i>HoLD</i> has been selected, the moment can be hold constant by pressing the [O]-key, and is updated by releasing the key. Advice: <i>Hold</i> is activated only, if <i>HOLD</i> is selected under parameter <i>DISPL</i>. <i>ActuA</i> shows the measuringg value for approx. 7 seconds, after this the device switches back on the parameterised display value. The same goes for <i>AVG</i>, here the sliding average values will be displayed. A sensor calibration is done by triggering of the digital input via <i>se.cal</i>, the flow diagram is shown in <i>Chapter 9</i>. The constant value <i>const</i> can be recalled via the digital input, or changed digit per digit. At <i>AL-1...AL-4</i> an output can be set and therewith e.g. a setpoint adjustment can be done. If <i>no</i> is selected, the [O]-key is without any function in the operation mode.</p>
	<p data-bbox="352 1310 758 1377">Special function digital input, <i>dIG.In</i>: Default: <i>no</i></p> <div data-bbox="384 1388 1337 1747">  </div> <p data-bbox="352 1780 1497 1848">In operation mode, the above shown parameters can be laid on the optional digital input, too. Function description see <i>tAst.4</i>.</p>
	<p data-bbox="352 1859 758 1892">Back to menu group level, <i>rEt</i>:</p> <p data-bbox="352 2004 1497 2038">With [P] the selection is confirmed and the device changes into menu group level „- fct -“.</p>

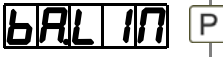
5.4.3. Bargraph functions

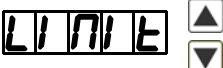

Menu level	Parameterisation level
<p>bASrc [P]</p>	<p>Bargraph, <i>Ba.src</i>: Default: <i>actua</i></p> <p> Actua [▲] [▼] MINUA [▲] [▼] MAXUA [▲] [▼] TOTAL [▲] [▼] HoLD [▲] [▼] AUG [▲] [▼] const [▲] [▼] dIFF [▲] [▼] [P] </p> <p>With this function the following values can be allocated to the display: the current measuring value, min/max value, totaliser value or the process-controlled hold-value, the sliding average value, the constant value or the difference between constant value and current value of the display. With [P] the selection is confirmed and the device changes into menu level.</p>
<p>bREnd [P]</p>	<p>Setting up the final value of the bargraph, <i>ba.END</i>: Default: <i>10000</i></p> <p>8 [P] 8 [P] 8 [P] 8 [P] 8 [▲] [▼] [P]</p> <p>Set the final value from the smallest to the highest digit with [▲] [▼] and confirm each digit with [P]. A minus sign can only be parameterised on the highest value digit. After the last digit, the display switches back to the menu level.</p>
<p>bROFF [P]</p>	<p>Setting up the initial value of the bargraph, <i>ba.off</i>: Default: <i>0</i></p> <p>8 [P] 8 [P] 8 [P] 8 [P] 8 [▲] [▼] [P]</p> <p>Set the initial value from the smallest to the highest digit with [▲] [▼] and confirm each digit with [P]. A minus sign can only be parameterised on the highest value digit. After the last digit, the display switches back to the menu level.</p>
<p>bRFct [P]</p>	<p>Selection of the bargraph functions, <i>ba.fct</i>: Default: <i>bar.fo</i></p> <p> barFo [▲] [▼] bar.rE [▲] [▼] barMI [▲] [▼] dot [▲] [▼] dotMI [▲] [▼] [P] </p> <p>The bargraph can be displayed with the following possibilities: bars forwards, bars backwards, bars starting out of the middle, bars from the middle, a dot display of the bargraph or a dot display with a permanently displayed midpoint. Confirm the selection by pressing the [P] button. The display then switches back to the menu level again.</p>

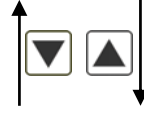
Menu level	Parameterisation level
	<p>Bargraph alarm, <i>bA.L1M</i>: Default: <i>no</i></p> <p>  </p> <p>If the alarms are triggered (<i>AL1</i> to <i>AI4</i>), a flashing of the dots can be assigned to the bargraph by selecting <i>Flash</i>. If <i>No</i> was adjusted the bargraph remains statical. With [P] the selection is confirmed and the device changes into menu level.</p>
	<p>Overflow behaviour, <i>ba.oue</i>: Default: <i>limit</i></p> <p>  </p> <p>The overflow behaviour of the bargraph can be defined to identify and evaluate faulty signals, e.g. via a control system. Overflow <i>Limit</i> means the bargraph remains still at adjusted min- or max-value. The complete bargraph display flashes during an overflow, if <i>Flash</i> was selected. With [P] the selection is confirmed and the device changes into menu level.</p>
	<p>Back to menu group level, <i>rEt</i>:</p> <p>With [P] the selection is confirmed and the device changes into menu group level „– bar –“.</p>

5.4.4. Safety parameters

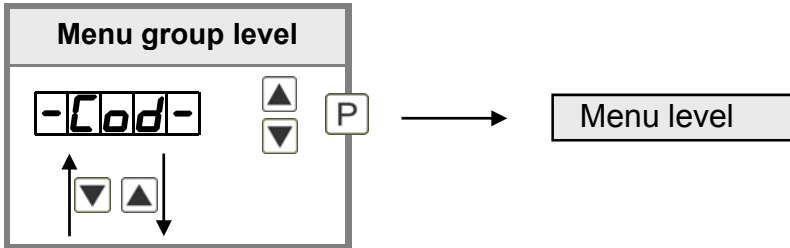



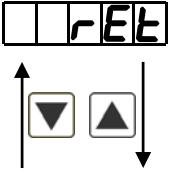



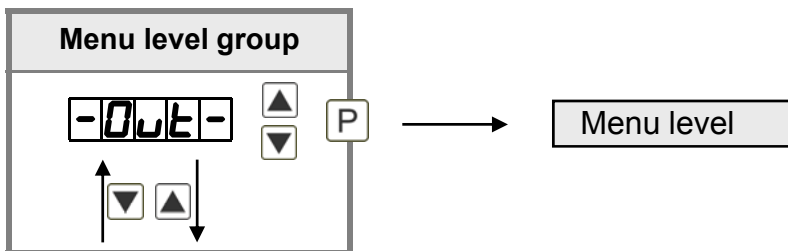

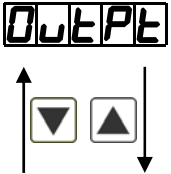
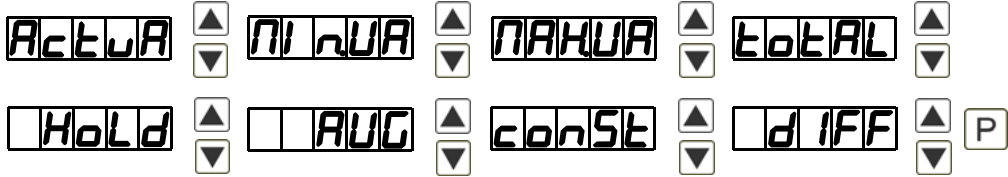
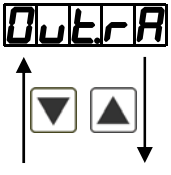
Menu level	Parameterisation level
	<p>Setting up the user code, U.Code: Default:0000</p> <p>Via this code, reduced sets of paramameters <i>outt.lle</i> and <i>all.llev</i> can be unlocked, in case of a locked programming. There is no access to further parameters via this code. The <i>U.Code</i> can only be changed via the correct input of the <i>A.Code</i> (master code).</p>
	<p>Master code, A.Code: Default:1234</p> <p>By entering <i>A.Code</i> the device will be unlocked and all parameters are released.</p>
	<p>Release/lock analog output parameter, Out.LE: Default: all</p> <p>Analog output parameter can be locked or released for the user:</p> <ul style="list-style-type: none"> - A t <i>En-oF</i> the initial or final value can be changed in operation mode. - A t <i>Out.EO</i> the output signal can be changed from e.g. 0-20 mA to 4-20 mA or 0-10 VDC. - A t <i>ALL</i> analog output parameters are released. - At <i>no</i> all analog output parameters are locked.
	<p>Release/lock alarm parameters, AL.LEU: Default: all</p> <p>This parameter describes the user relase/user lock of the alarm.</p> <ul style="list-style-type: none"> - <i>LIMIT</i>, here only the range of value of the threshold values 1-4 can be changed. - - <i>ALrM.L</i>, here the range of value and the alarm trigger can be changed. - <i>ALL</i>, all alarm parameters are released. - <i>no</i>, all alarm parameters are locked.

Menu level	Parameterisation level
	<p>Back to menu group level, <i>rEt</i>:</p> <p>With [P] the selection is confirmed and the device changes into menu group level „- COD-“.</p>

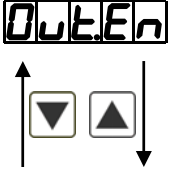
5.4.5. Analog output parameters

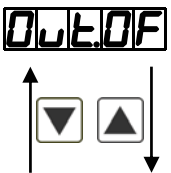

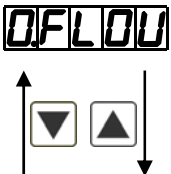
Menu level	Parameterisation level
	<p>Selection reference of analog output, <i>OutPt</i>: Default: <i>actua</i></p> <p>  </p> <p>The analog output signal can refer to different functions, in detail these are the current measurand, the min-value, the max-value, the totaliser-/sum function, the constant value or the difference between current measurand and constant value. If <i>HoLd</i> is selected, the signal of the analog output will be kept. It can be continued processing after a deactivation of <i>HoLd</i>. With [P] the selection is confirmed and the device changes into menu level.</p>
	<p>Selection analog output, <i>Out.rA</i>: Default: 4-20</p> <p>  </p> <p>Three output signals are available 0-10 VDC, 0-20 mA and 4-20 mA. Select the demanded signal with this function.</p>

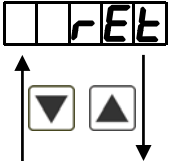

Menu level	Parameterisation level
	<p>Setting the final value of the analog output, <i>Out.En:</i> Default: 10000</p>  <p>The final value is adjusted from the smallest to the highest digit with [▲] [▼] and confirmed digit per digit with [P]. A minus sign can only be parameterised on the highest digit. After the last digit the device changes back into menu level.</p>
	<p>Setting the initial value of the analog output, <i>Out.OF:</i> Default: 00000</p>  <p>The initial value is adjusted from the smallest to the highest digit with [▲] [▼] and confirmed digit per digit with [P]. A minus sign can only be parameterised on the highest digit. After the last digit the device changes back into menu level.</p>
	<p>Overflow behaviour, O.FLoU: Default: <i>edge</i></p>  <p>To recognise and evaluate faulty signals, e.g. by a controller, the overflow behaviour of the analog output can be defined. As overflow can be seen either EdGGE, that means the analog output runs on the set limits e.g. 4 and 20 mA, or to.OFF (input value smaller than initial value, analog output switches on e.g. 4 mA), to.End (higher than final value, analog output switches on e.g. 20 mA). If to.Min or to.MAX is set, the analog output switches on the smallest or highest possible binary value. This means that values of e.g. 0 mA, 0 VDC or values higher than 20 mA or 10 VDC can be reached. With [P] the selection is confirmed and the device changes into menu level.</p>
	<p>Back to menu group level, rEt:</p> <p>With [P] the selection is confirmed and the device changes into menu group level „- out -“.</p>

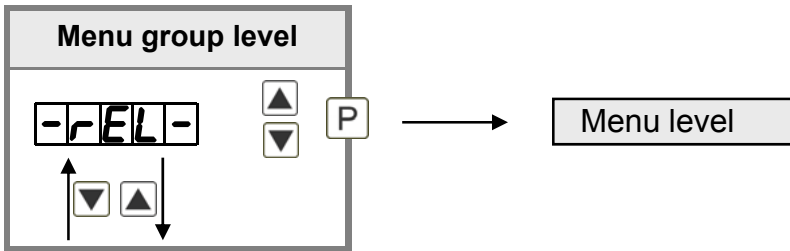
5.4.6. Relay functions





Menu level	Parameterisation level												
	<p>Alarm relay 1, rEL-1: Default: al-1</p> <p> </p> <p>Each setpoint (optional) can be linked up via 4 alarms (by default). This can either be inserted at activated alarms AL-1/4 or de-activated alarms ALn1/4. If LOGIC is selected, logical links are available in the menu level Log-1 and Com-1. One can only get to these two menu levels via LOGIC, at all other selected functions, these two parameters are overleaped. Via On/OFF the setpoints can be activated/de-activated, in this case the output and the setpoint display are set/not set on the front of the device. The parameters Cal, Cal.of and CAL.en can only be used in accordance with the semi-automatic calibration (<i>Chapter 9. Sensor alignment</i>). At Cal the relay switches during sensor calibration, at cal.of during offset calibration and at Cal.en during the calibration of the final value. With [P] the selection is confirmed and the device changes into menu level.</p>												
	<p>Logic relay 1, <i>Log-1</i> Default: or</p> <p> </p> <p>Here, the switching behaviour of the relay is defined via a logic link, the following schema describes these functions with inclusion of AL-1 and AL-2. This parameter is only possible if LOGic was selected under REI-1.</p> <table border="1"> <tbody> <tr> <td></td> <td>$A1 \vee A2$ — —</td> <td>As soon as a selected alarm is activated, the relay operates. Equates to operating current principle.</td> </tr> <tr> <td></td> <td>$A1 \vee A2 = A1 \wedge A2$</td> <td>The relay operates only, if no selected alarm is active. Equates to quiescent current principle.</td> </tr> <tr> <td></td> <td>$A1 \wedge a2$ — —</td> <td>The relay operates only, if all selected alarms are active.</td> </tr> <tr> <td></td> <td>$A1 \wedge A2 = A1 \vee A2$</td> <td>As soon as a selected alarm is not activated, the relay operates.</td> </tr> </tbody> </table> <p>With [P] the selection is confirmed and the device changes into menu level.</p>		$A1 \vee A2$ — —	As soon as a selected alarm is activated, the relay operates. Equates to operating current principle.		$A1 \vee A2 = A1 \wedge A2$	The relay operates only, if no selected alarm is active. Equates to quiescent current principle.		$A1 \wedge a2$ — —	The relay operates only, if all selected alarms are active.		$A1 \wedge A2 = A1 \vee A2$	As soon as a selected alarm is not activated, the relay operates.
	$A1 \vee A2$ — —	As soon as a selected alarm is activated, the relay operates. Equates to operating current principle.											
	$A1 \vee A2 = A1 \wedge A2$	The relay operates only, if no selected alarm is active. Equates to quiescent current principle.											
	$A1 \wedge a2$ — —	The relay operates only, if all selected alarms are active.											
	$A1 \wedge A2 = A1 \vee A2$	As soon as a selected alarm is not activated, the relay operates.											





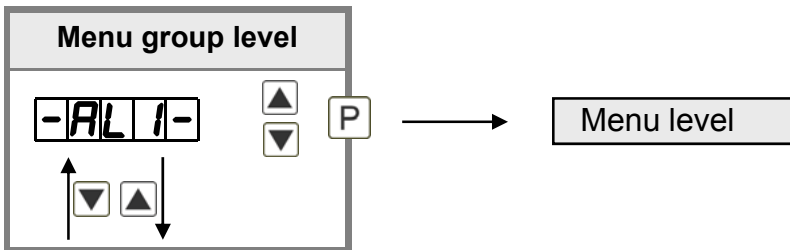

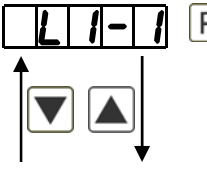

Menu level	Parameterisation level												
<p>CoM-1 [P]</p> <p>↑ ↓</p>	<p>Alarms for relay 1, CoM-1: Default:a.1</p> <p>R1 [▲] [▼] R2 [▲] [▼] R1234 [▲] [▼] [P]</p> <p>The allocation of the alarms to relay 1 happens via this parameter, one alarm or a group of alarms can be chosen. This parameter is only available if LOGIC was selected under REI-1. With [P] the selection is confirmed and the device changes into menu level.</p>												
<p>rEL-2 [P]</p> <p>↑ ↓</p>	<p>Alarm relay 2, rEL-2: Default:a1-2</p> <p>AL-1 AL-4 [▲] [▼] AL-n1 AL-n4 [▲] [▼]</p> <p>LOGIC [▲] [▼] OFF [▲] [▼] On [▲] [▼] CAL [▲] [▼]</p> <p>CALOF [▲] [▼] CALen [▲] [▼] [P]</p> <p>Each setpoint (optional) can be linked up via 4 alarms (by default). This can either be inserted at activated alarms AI-1/4 or de-activated alarms AI$\bar{1}$/4. If LOGIC is selected, logical links are available in the menu level Log-1 and Com-1. One can only get to these two menu levels via LOGIC, at all other selected functions, these two parameters are overlapped. Via On/OFF the setpoints can be activated/de-activated, in this case the output and the setpoint display are set/not set on the front of the device. The parameters Cal, Cal.of and CAL.en can only be used in accordance with the semi-automatic calibration (<i>Chapter 9. Sensor alignment</i>). At Cal the relay switches during sensor calibration, at cal.of during offset calibration and at Cal.en during the calibration of the final value. With [P] the selection is confirmed and the device changes into menu level.</p>												
<p>LoG-2 [P]</p> <p>↑ ↓</p>	<p>Logic relay 2, Log-2: Default: OR</p> <p>or [▲] [▼] nor [▲] [▼] And [▲] [▼] nAnd [▲] [▼] [P]</p> <p>Here, the switching behaviour of the relay is defined via a logic link, the following schema describes these functions with inclusion of AL-1 and AL-2. This parameter is only possible if LOgic was selected under REI-1.</p> <table border="1" data-bbox="336 1547 1498 1854"> <tbody> <tr> <td data-bbox="336 1547 523 1621">or</td> <td data-bbox="523 1547 826 1621">$A1 \vee A2$</td> <td data-bbox="826 1547 1498 1621">As soon as a selected alarm is activated, the relay operates. Equates to operating current principle.</td> </tr> <tr> <td data-bbox="336 1621 523 1695">nor</td> <td data-bbox="523 1621 826 1695">$\overline{A1 \vee A2} = \overline{A1} \wedge \overline{A2}$</td> <td data-bbox="826 1621 1498 1695">The relay operates only, if no selected alarm is active. Equates to quiescent current principle.</td> </tr> <tr> <td data-bbox="336 1695 523 1769">And</td> <td data-bbox="523 1695 826 1769">$A1 \wedge a2$</td> <td data-bbox="826 1695 1498 1769">The relay operates only, if all selected alarms are active.</td> </tr> <tr> <td data-bbox="336 1769 523 1843">nAnd</td> <td data-bbox="523 1769 826 1843">$\overline{A1 \wedge A2} = \overline{A1} \vee \overline{A2}$</td> <td data-bbox="826 1769 1498 1843">As soon as a selected alarm is not activated, the relay operates.</td> </tr> </tbody> </table> <p>With [P] the selection is confirmed and the device changes into menu level.</p>	or	$A1 \vee A2$	As soon as a selected alarm is activated, the relay operates. Equates to operating current principle.	nor	$\overline{A1 \vee A2} = \overline{A1} \wedge \overline{A2}$	The relay operates only, if no selected alarm is active. Equates to quiescent current principle.	And	$A1 \wedge a2$	The relay operates only, if all selected alarms are active.	nAnd	$\overline{A1 \wedge A2} = \overline{A1} \vee \overline{A2}$	As soon as a selected alarm is not activated, the relay operates.
or	$A1 \vee A2$	As soon as a selected alarm is activated, the relay operates. Equates to operating current principle.											
nor	$\overline{A1 \vee A2} = \overline{A1} \wedge \overline{A2}$	The relay operates only, if no selected alarm is active. Equates to quiescent current principle.											
And	$A1 \wedge a2$	The relay operates only, if all selected alarms are active.											
nAnd	$\overline{A1 \wedge A2} = \overline{A1} \vee \overline{A2}$	As soon as a selected alarm is not activated, the relay operates.											

Menu level	Parameterisation level
	<p>Alarms for relay 2, CoM-2: Default: A.2</p> <p>CoM-2 P A1 A2 ... A1234 P</p> <p>The allocation of the alarms to relay 1 happens via this parameter, one alarm or a group of alarms can be chosen. This parameter is only available if <i>LOGIC</i> was selected under <i>REI-1</i>. With [P] the selection is confirmed and the device changes into menu level.</p>
	<p>Back to menu group level, rEt:</p> <p>With [P] the selection is confirmed and the device changes into menu group level „- rel -“.</p>

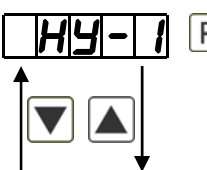
5.4.7. Alarm parameters

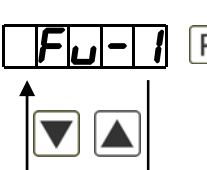
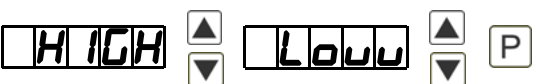
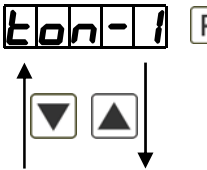

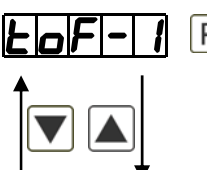
Menu level	Parameterisation level
	<p>Dependency alarm1, ALrM.1: Default: <i>actua</i></p> <p>ALrM.1 P Actua Minua Maxua TotalAL Hold AUG const dIFF EHTEr P</p> <p>The dependency of alarm 1 can be related to special functions, in detail these are the current measuring value, the min-value, the max-value, the totaliser-/sum-value, the constant value or the difference between the current measurand and the constant value. If <i>Hold</i> was selected, then the alarm is hold and processed just after deactivation of <i>HOLD</i>. <i>EHTEr</i>, causes the dependency either by pressing the [O]-key on the front of the housing or by an external signal via the digital input. With [P] the selection is confirmed and the device changes into menu level.</p> <p>Example:</p> <p>By using the maximum value <i>Alarm.1 = Max.va</i> in combination with a threshold monitoring <i>Fu-1 = High</i>, an alarm confirmation can be realised. Use the navigation keys, the fourth key or the digital input for confirmation.</p>

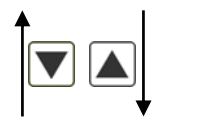
Menu level	Parameterisation level
	<p>Threshold values / Limit values, <i>LIL-1</i>: Default: 2000</p>  <p>The limit value defines the threshold, that activates/deactivates an alarm.</p>
	<p>Hysteresis for threshold values, <i>HY-1</i>: Default: 00000</p>  <p>The delayed reaction of the alarm is the difference to the threshold value, which is defined by the hysteresis.</p>
	<p>Function for threshold value undercut/exceedance, <i>FFu-1</i>: Default: <i>high</i></p>  <p>A limit value undercut is selected with <i>Lowu</i> (for LOW = lower limit value), a limit value exceedance with <i>High</i> (for HIGH = higher limit value). If e.g. limit value 1 is on a threshold level of 100 and allocated with function <i>High</i>, an alarm is activated by reaching the threshold level. If the threshold value was allocated to <i>Low</i>, an alarm will be activated by undercutting the threshold value, as long as the hysteresis is zero.</p>
	<p>Switching-on delay, <i>ton-1</i>: Default: 000</p>  <p>For limit value 1 one can preset a delayed switching-on of 0-100 seconds.</p>
	<p>Switching-off delay, <i>toF-1</i>: Default: 000</p>  <p>For limit value 1 one can preset a delayed switching-off of 0-100 seconds.</p>
	<p>Back to menu group level, <i>rEt</i>:</p> <p>With [P] the selection is confirmed and the device changes into menu group level „- A11 -“.</p>

The same applies for A1/2 to a1/8.

5.4.8. Totaliser (Volume metering)

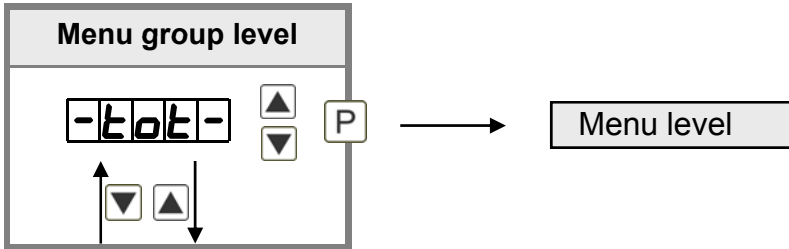

Menu level	Parameterisation level
<p>total P</p> <p>↑ ↓</p>	<p>Totaliser state, total: Default: <i>off</i></p> <p>OFF STEAD TEMP P</p> <p>The totaliser makes measurements on a time base of e.g. l/h possible, at this the scaled input signal is integrated by a time and steadily (select Stead) or temporarily (select temp) safed. Select the constant storage for consumption measurements and the quick storage for frequently filling processes. During the constant storage STEAD the current sum value is safed at each totaliser reset. Furthermore it is safed every 30 minutes in the not-volatile storage of the device. If Off is selected, the function is deactivated. With [P] the selection is confirmed and the device changes into menu level.</p>
<p>tbase P</p> <p>↑ ↓</p>	<p>Time base, t.base: Default: <i>sec</i></p> <p>SEC Min hour P</p> <p>Under this parameter the time base of the measurement can be preset in seconds, minutes or hours.</p>
<p>Facto P</p> <p>↑ ↓</p>	<p>Totaliser factor, Facto: Default: <i>1e0</i></p> <p>1E0 ... 1E6 P</p> <p>At this, the factor (1E0...1E6) respectively the divisor for the internal calculation of the measuring value is assigned.</p>
<p>totddt P</p> <p>↑ ↓</p>	<p>Setting up the decimal point for the totaliser, tot.ddt: Default: <i>0</i></p> <p>0 00 000 0000 00000 P</p> <p>The decimal point of the device can be adjusted with the navigation keys [▲] [▼]. With [P] the selection is confirmed and the device changes into menu level.</p>

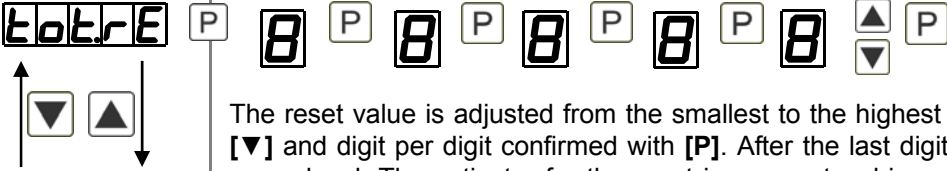
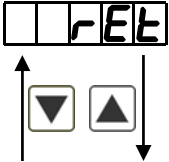
Menu level	Parameterisation level
	<p>Totaliser reset, tot t t.re: Default: 000</p> <p>The reset value is adjusted from the smallest to the highest digit with the navigation keys [▲] [▼] and digit per digit confirmed with [P]. After the last digit, the display switches back to the menu level. The activator for the reset is parameter driven via the 4th key or via the optional digital input.</p>
	<p>Back to menu group level, rEt:</p> <p>With [P] the selection is confirmed and the device changes into menu group level „- tot -“ .</p>

Programming interlock, run:

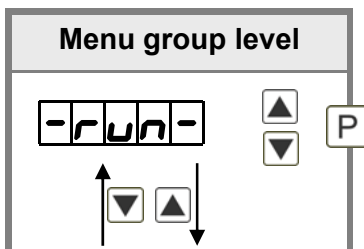

Description see page 11, menu level run

6. Reset to default values

To return the unit to a **defined basic state**, a reset can be carried out to the default values.

The following procedure should be used:

- Switch off the power supply
- Press button [P]
- Switch on voltage supply and press [P]-button until „-----“ is shown in the display.

With reset, the default values of the program table are loaded and used for subsequent operation. This puts the unit back to the state in which it was supplied.

Caution! All application-related data are lost.

7. Alarms / Relays

This device has 4 virtual alarms that can monitor one limit value in regard of an undercut or exceedance. Each alarm can be allocated to an optional relay output S1-S2; furthermore alarms can be controlled by events like e.g. hold-value or min-/max-value.

Function principle of alarms / relays	
Alarm / Relay x	deactivated, instantaneous value, min-/max-value, hold-value, totaliser value, sliding average value, constant value, difference between instantaneous value and constant value or an activation via the digital input
Switching threshold	Threshold / limit value of the change-over
Hysteresis	Broadness of the window between the switching thresholds
Working principle	Operating current / Quiescent current

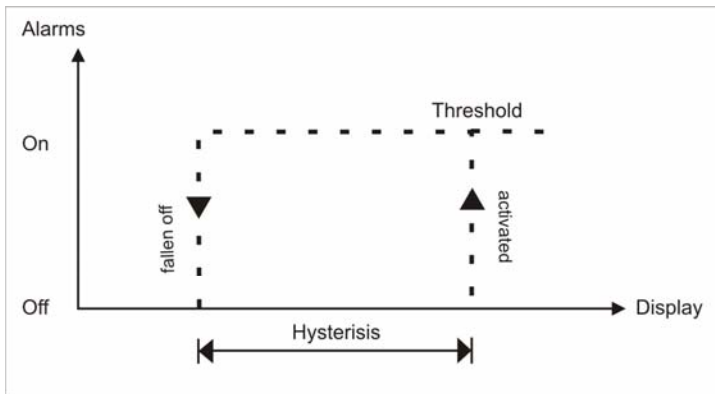

Operating current

By operating current the alarm S1-S2 is off below the threshold and on on reaching the threshold.

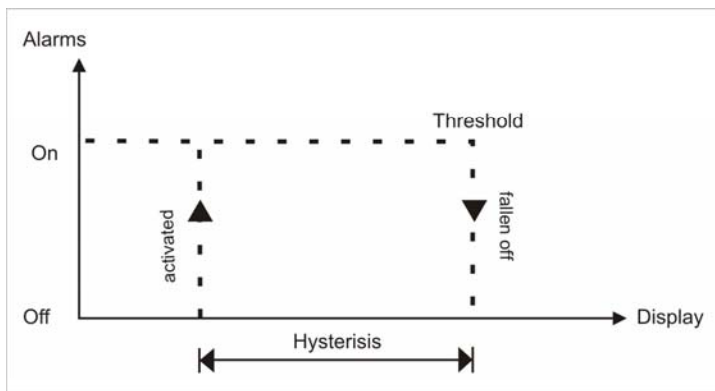

Quiescent current

By quiescent current the alarm S1-S2 is on below the threshold and switched off on reaching the threshold.

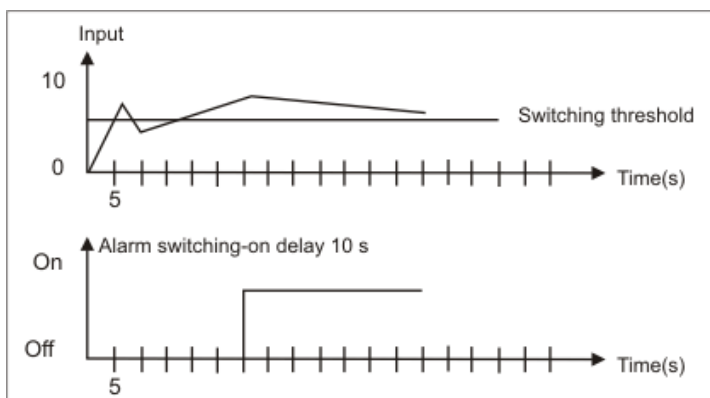

Switching-on delay

The switching-on delay is activated via an alarm and e.g. switched 10 seconds after reaching the switching threshold, a short-term exceedance of the switching value does not cause an alarm, respectively does not cause a switching operation of the relay. The switching-off delay operates in the same way, keeps the alarm / the relay switched longer for the parametrised time.

8. Sensor alignment offset / final value

The device is equipped with a semi-automatic sensor calibration (**SENSu/SENSa**). A switching output operates the trimming resistor, which exists in some sensors. An adjustment of offset and final value takes place, after which the sensor can be used directly. Depending on parameterisation, the calibration can be realized via the fourth key or via the digital input. It is possible to key during the calibration steps. So, reference signals can be connected manually. However, the calibration will be interrupted after 30 seconds.

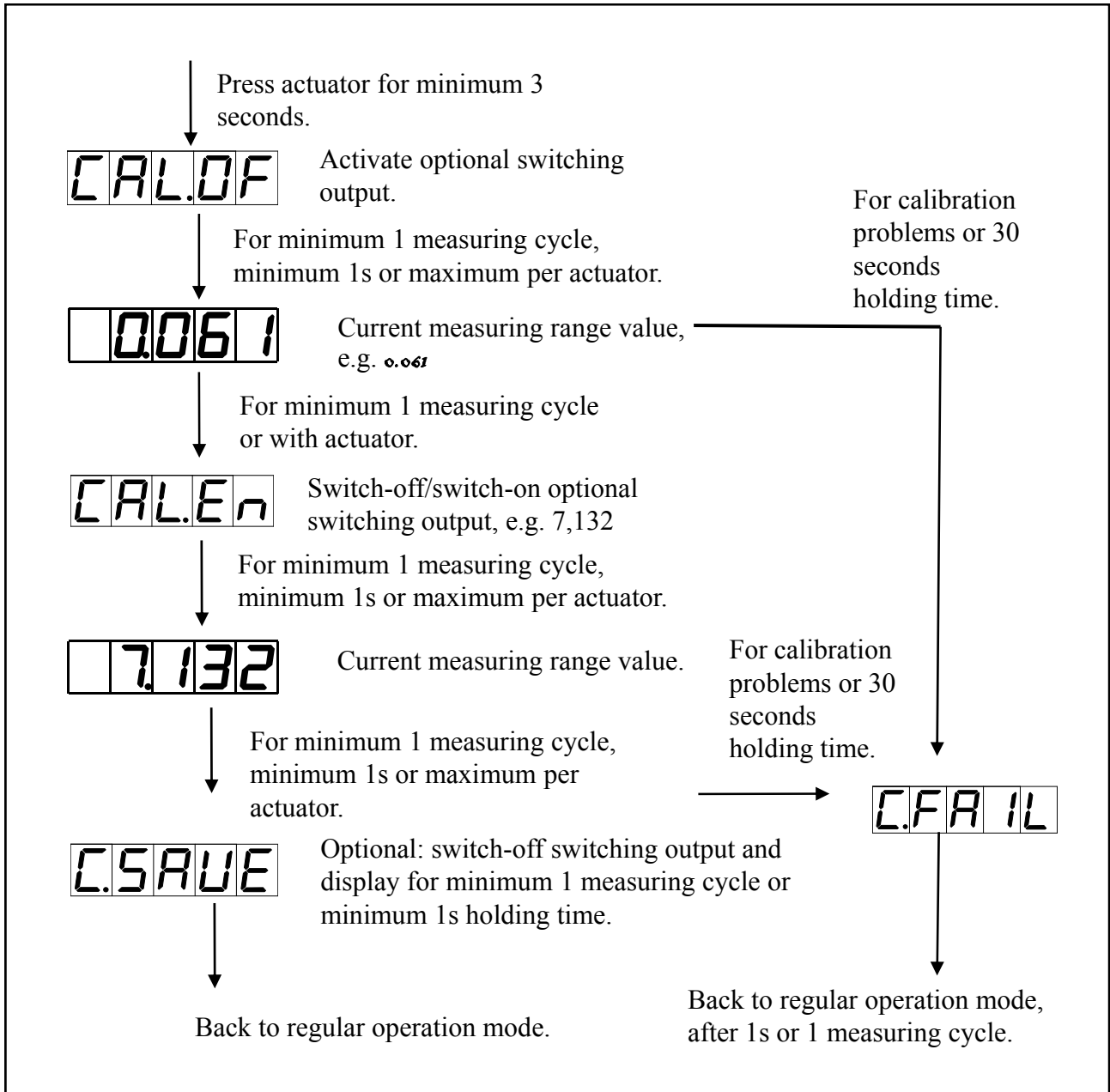

9. Technical data

Panel meter				
Dimensions	Field housing: 96x96x56 mm (BxHxD)			
	Installation housing: 96x96x82 mm (BxHxD) including plug-in terminal			
Panel cut-out	91.0 ^{+0.6} x 91.0 ^{+0.6} mm			
Wall thickness	up to 10 mm			
Fixing	screw elements			
Material	LEXAN 500R, black			
Sealing material	EPDM, 65 Shore, black			
Protection class	standard IP65 (front), IP00 (back side)			
Weight	approx. 330 g			
Connection	plug-in terminal; wire cross section up to 2.5 mm ²			
Display				
Digit height	14 mm			
Segment colour	red			
Display range	-19999 to 99999			
Setpoints	one LED per setpoint			
Overflow	horizontal bars at the top			
Underflow	horizontal bars at the bottom			
Display time	0.1 to 10.0 seconds			
Bargraph	55 segments in a 270° angle			
Bargraph colour	red			
Input				
Measuring range	Ri	Measuring error	Digit	
min. -22...max. 24 mA	0/4 – 20 mA	~100 Ω	0.1 % of measuring range	±1
min. -12...max. 12 VDC	0-10 VDC	~200 kΩ	0.1 % of measuring range	±1
Digital input	< 2,4 V OFF, 10 V ON, max. 30 VDC R _i ~ 5 kΩ			
Accuracy				
Drift of temperature	100 ppm / K			
Measuring time	0.1...10.0 seconds			
Measuring principle	U/F-conversion			
Resolution	approx. 18 Bit at 1 second measuring time			

Output	
Sensor supply	24 VDC / 50 mA; 12 VDC / 50 mA; 5 VDC / 20 mA
Analog output	0/4-20 mA /burden 350 Ω or 0-10 VDC / 10 kOhm, 16 Bit
Switching outputs	
Relay with change-over contacts Switching cycles	250 VAC / 5 AAC; 30 VDC / 5 ADC 30 x 10 ³ at 5 AAC, 5 ADC ohm resistive burden 10 x 10 ⁶ mechanically Division according to DIN EN50178 / Characteristics according to DIN EN60255
Memory	
Data life	EEPROM ≥ 100 years at 25°C
Ambient conditions	
Working temperature	0°...50°C for panel meters, -20°...60°C for built-on devices
Storing temperature	-20...80°C
Weathering resistance	relative humidity 0-80% on years average without dew
Height	up to 2000 m above sea level
EMV	
	EN 61326
CE-sign	
	Conformity according to directive 2004/108/EG
Safety standard	
	Accroding to low voltage directive 2006/95/EG EN 61010; EN 60664-1

10. Safety advices

Please read the following safety advice and the assembly *chapter 1* before installation and keep it for future reference.

Proper use

The **ADI-1V-device** is designed for the evaluation and display of sensor signals.



Danger! Careless use or improper operation can result in personal injury and/or damage to the equipment.

Control of the device

The panel meters are checked before dispatch and sent out in perfect condition. Should there be any visible damage, we recommend close examination of the packaging. Please inform the supplier immediately of any damage.



Installation

The **ADI-1V-device** must be installed by a suitably **qualified specialist** (e.g. with a qualification in industrial electronics).

Notes on installation

- There must be no magnetic or electric fields in the vicinity of the device, e.g. due to transformers, mobile phones or electrostatic discharge.
- The **fuse rating** of the supply voltage should not exceed a value of **6A N.B. fuse**.
- Do not install **inductive consumers** (relays, solenoid valves etc.) near the device and **suppress** any interference with the aid of RC spark extinguishing combinations or free-wheeling diodes.
- Keep input, output and supply lines separate from one another and do not lay them parallel with each other. Position “go” and “return lines” next to one another. Where possible use twisted pair. So, you receive best measuring results.
- Screen off and twist sensor lines. Do not lay current-carrying lines in the vicinity. Connect the **screening on one side** on a suitable potential equaliser (normally signal ground).
- The device is not suitable for installation in areas where there is a risk of explosion.
- Any electrical connection deviating from the connection diagram can endanger human life and/or can destroy the equipment.
- The terminal area of the devices is part of the service. Here electrostatic discharge needs to be avoided. Attention! High voltages can cause dangerous body currents.
- Galvanic insulated potentials within one complex need to be placed on a appropriate point (normally earth or machines ground). So, a lower disturbance sensibility against impacted energy can be reached and dangerous potentials, that can occur on long lines or due to faulty wiring, can be avoided.

11. Error elimination

	Error description	Measures
1.	<p>The unit permanently indicates overflow.</p> 	<ul style="list-style-type: none"> • The input has a very high measurement, check the measuring circuit. • With a selected input with a low voltage signal, it is only connected on one side or the input is open. • Not all of the activated setpoints are parameterised. Check if the relevant parameters are adjusted correctly.
2.	<p>The unit permanently shows underflow.</p> 	<ul style="list-style-type: none"> • The input has a very low measurement, check the measuring circuit . • With a selected input with a low voltage signal, it is only connected on one side or the input is open. • Not all of the activated setpoints are parameterised. Check if the relevant parameters are adjusted correctly.
3.	<p>The word "HELP" lights up in the 7-segment display.</p>	<ul style="list-style-type: none"> • The unit has found an error in the configuration memory. Perform a reset on the default values and re-configure the unit according to your application.
4.	<p>Program numbers for parameterising of the input are not accessible.</p>	<ul style="list-style-type: none"> • Programming lock is activated • Enter correct code
5.	<p>"Err1" lights up in the 7-segment display</p>	<ul style="list-style-type: none"> • Please contact the manufacturer if errors of this kind occur.
6.	<p>The device does not react as expected.</p>	<ul style="list-style-type: none"> • If you are not sure if the device has been parameterised before, then follow the steps as written in <i>chapter 6</i>. and set it back to its delivery status.

12. Disposal

Note!

- Avoid environmental damage caused by media-contaminated parts
- Dispose of the device and packaging in an environmentally friendly manner
- Comply with applicable national and international disposal regulations and environmental regulations.

Batteries

Batteries containing pollutants are marked with a sign consisting of a crossed-out garbage can and the chemical symbol (Cd, Hg, Li or Pb) of the heavy metal that is decisive for the classification as containing pollutants:

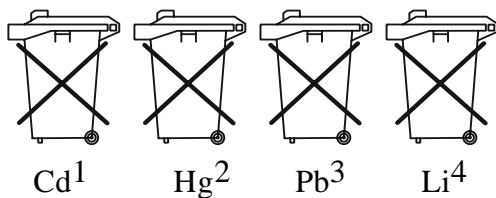

1. „Cd" stands for cadmium
2. Hg" stands for mercury
3. „Pb" stands for lead
4. Li" stands for lithium

Electrical and electronic equipment



13. EU Declaration of Conformance

We, KOBOLD Messring GmbH, Hofheim-Ts, Germany, declare under our sole responsibility that the product:

Universal Indicating Unit Model: ADI-1V...

to which this declaration relates is in conformity with the standards noted below:

EN 61010-1:2010+A1:2019+A1:2019/AC:2019 Safety requirements for electrical equipment measurement, control and laboratory use - Part 1: General requirements

EN 61326-1:2013 Electrical equipment for measurement, control and laboratory use - EMC requirements - Part 1: General requirements

EN 63000:2018 Technical documentation for the assessment of electrical and electronic products with respect to the restriction of hazardous substances

Also the following EC guidelines are fulfilled:

2014/30/EU	EMC Directive
2014/35/EU	Low Voltage Directive
2011/65/EU	RoHS
2015/863/EU	Delegated Directive (RoHS III)

Hofheim, 11 Jan. 2023



H. Volz
General Manager

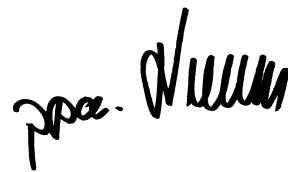

M. Wenzel
Proxy Holder