



PROCESS INSTRUMENTATION

Weighing your world

Dynamic and static instrumentation solutions.
usa.siemens.com/weighing

SIEMENS



So, what do you need measured?

Crushed stone? We can do that.

Ore? That too.

Cement? Coal? Food? Chemicals? Absolutely.

With our field-proven weighing electronics, load cells, conveyor belt scales, solids flowmeters, and weighfeeders, Siemens weighs your world. Saving you money, time - and a whole lot of stress - along the way.



Contents

Applications overview	4-7
Siwarex for smartphones	8-9
Weighing electronics	10-11
Load cells	12-13
Weighing modules with optional stand-alone displays	14
Integrator electronics	15
Belt scales	16-18
Speed sensors	19
Solids flowmeters	20
Weighfeeders	21
Process protection	22
Remote monitoring and displays	23
Training	24
Sales and support	25
Totally integrated automation	26-27



Weighing what matters...

Siemens isn't new to the weighing game, as you'll see in the following application stories.

Flexible weighing system gets the rocks rolling

The main area of BMK's quarry operations includes the mining of shell limestone, which is used in various grain and stone sizes in construction and civil engineering as well as for the production of concrete.

An old conveyor belt scale was retrofitted in this factory with SIWAREX WP241 conveyor belt scale electronics, which got the scale back into operation.

The open design of the SIWAREX electronic weighing system enabled the customer to easily perform the conversion and commissioning themselves. The scale was integrated into the existing Eaton PLC system via Modbus.

Suitable Siemens weighing system products

- SIWAREX WP241 electronic weighing system
- SIWAREX FTC electronic weighing system
- Conveyor belt scales

System-integrated weighing technology raises productivity

The Spanish company AiCrov offers filling solutions for various industries and products. Filling quantities range from 0.250 kg to 1,500 kg depending on the customer's requirements.

An important quality factor for filling and packaging is the precise agreement of the actual content with the specified filling quantity.

To develop a new series of filling machines, AiCrov relies on SIWAREX weighing components, which are directly integrated in SIMATIC S7. The seamless internal system communication thereby enables very fast, accurate, and reliable control of the filling process, especially at high speeds.

Suitable Siemens weighing system products

- SIWAREX WP231 electronic weighing system
- SIWAREX WP251 electronic weighing system
- SIWAREX FTA electronic weighing system
- SIWAREX WL230, WL260, WL280 load cells

Space-saving and precise checkweighing

Checkweighers are indispensable for companies in the food, pharmaceutical, and chemical industries. They check the final weight of the packaged food, cosmetics, and many other products. Not only speed, but also accuracy plays a significant role here.

Siemens offers the SIWAREX WL260 SP-S SC platform load cell with a very little deflection and a maximum accuracy rating of up to C4 MR.

It is a perfect and less expensive alternative for medium- to high-performance force compensation load cells and checkweighers. With its ingress protection rating of IP69K the SIWAREX WL260 SP-S SC is ideal for applications in the food and beverage or pharmaceutical industries.

Suitable Siemens weighing system products

- SIWAREX FTA electronic weighing system
- SIWAREX WL260 load cells SP-S-SC

...one application at a time.

From the rigors of heavy industry to the precision required in food and pharmaceutical manufacturing, we've weighed it all.

Withstanding the test of time: solids flowmeters and cement

For over thirty years, St. Marys Cement in Canada has depended on Siemens weighing technology.

One of the company's five solids flowmeters monitors the coarse returns of the finish mill below the separator. Material input needs to be accurate and instantaneous, since the load of the mill must be kept at a desired level for the most efficient grinding.

This solution has performed well for decades at St. Marys Cement. The result is a quality product and only minimal equipment maintenance and cleaning requirements.

Suitable Siemens products

- SITRANS WF330 flowmeter
- SITRANS WFS320 sensing head

Belt scale time savings in organic waste recycling

Organic Recycling Systems Pvt. Ltd. (ORS) is an integrated solid waste management company in India.

With the installation of Siemens weighing technology, ORS reduced belt scale calibration from every other day to once each month - a savings of 300 hours every year!

The scale was installed on a one-month trial and tested in comparison to independent truck scales to confirm its repeatable 0.5% accuracy.

The company now has a compact, robust, and reliable solution with local expertise from product and industry experts.

Suitable Siemens products

- Milltronics MSI belt scale
- Milltronics BW500/L integrator
- SITRANS WS300 speed sensor

From grapes to a good wine: high quality has high demands

The winery of Château Gruaud-Larose in the Bordeaux district produces high-quality wines.

Harvested grapes must be weighed accurately to ensure traceability, so the winery chose Siemens food-grade weighfeeders. Stainless steel sliding supports which transport the belt are very easy to clean and routine maintenance is quick and easy.

With this compact solution, the winery has gained extra space and achieved a significantly higher degree of working comfort, including reduced noise exposure, easier cleaning, and greater processing flexibility.

Suitable Siemens products

- SITRANS WW200 weighfeeder
- Milltronics BW500 integrator

But don't just take our word on it! For more application stories from around the world, check out [siemens.com/weighing](https://www.siemens.com/weighing).



Weighing without barriers

SIWAREX for smartphones: with Sm@rt Client

An app for SIWAREX? WinCC Sm@rtServer makes it possible. The app both modernizes and simplifies remote control and monitoring of SIMATIC HMI systems via wireless LAN or via the Intranet/Internet.



Easily equip your smartphone or tablet with the Sm@rtClient app for Android or iOS systems. Activate it on the touch panel of the Sm@rtServer service and watch as service and maintenance personnel can now conveniently access machinery and equipment around the world.

The Sm@rtServer design enables mobile, location-independent monitoring and operation of parameters and functions stored on the panel. On a SIMATIC TP700 Comfort Touch Panel, for example, directly connect up to eight scales via a switch.

Using the Sm@rtServer services on the SIMATIC Touch Panel and the Sm@rtClient app on the smartphone or tablet, you can transmit the user interface of the HMI directly to the smartphone or tablet via Wi-Fi. This means that operators have mobile access to all scales from the same operating layout of the touch panel, giving SIWAREX electronic weighing systems extreme flexibility.



Weighing systems without language barriers

What happens when humans and machines speak the same language? Training costs and operating errors are minimized and production safety is guaranteed.

Siemens weighing systems do exactly that - offering multilingual electronic weighing systems at the highest level.

SIWAREX scale applications can be implemented in a variety of languages thanks to seamless integration in SIMATIC. Language versions are available for filling, conveyor, and differential dosing scales - and can be added and adapted at any time.

Switch languages as needed - operators and service engineers can change the interface easily and quickly to their own native tongue.

Ready for use: the complete weighing application

You have enough going on in your facility - so we've made "ready-for-use" software packages for a variety of system configurations. CPU, HMI, TIA Portal WinCC flexible - whatever you're looking for.

And for all of your applications, from fill level measurement to differential dosing scales - and everything in between.

Of course, with all of Siemens' wide range of off-the-shelf software packages, our service and support team is always available when you need us.

Siemens weighing commissioning? Simple. Economical. And best of all? Quick.

A world of approvals and certificates

So, what certificates or approvals do you need? Legal-for-trade. Explosion proof. Food grade.

And how about functional requirements, like calibration capability, electrical safety, and EMC standards? With Siemens weighing technology, your questions are our answers.

Take the Siemens Milltronics MSI belt scale, for example - you're looking at a scale with the most approvals of any around the globe. And SIWAREX technology? It exceeds current EMC standards to ensure reliable measurement every time.

Perfectly suited to whatever your application requires. We approve of that.



**Efficient filling process? Fast weighing? Exact dosing?
SIWAREX WP251 controls dosing and bottling processes
autonomously, effortlessly filling the highest requirements.**

In conjunction with a SIMATIC S7-1200 CPU, SIWAREX WP251 offers a freely programmable, flexible, and powerful weighing system. Or, use the module as a stand-alone system, depending on your application.





With the SIWAREX family of electronics and load cells, not only are you choosing the highest quality in construction, longlasting performance, and easy integration into your weighing systems, you are also opening the doors to Siemens' comprehensive spectrum of automation and instrumentation.





Part of Siemens Totally Integrated Automation (TIA), SIWAREX modules can be integrated into SIMATIC S7 and expanded as required to meet your individual requirements. With TIA, Siemens is the only manufacturer to offer an integrated range of products and systems for automation in all industry sectors.

SIMATIC S7-1200 integrated weighing electronic for dosing and batching

- legal for trade
- state of the art accuracy and measurement rates
- stand-alone ability

SIWAREX weighing modules

	SIWAREX WP231	SIWAREX WP241	SIWAREX WP251	SIWAREX WP321	SIWAREX WP521 ST/ SIWAREX WP522 ST
					
Order No.	7MH4960-2AA01	7MH4960-4AA01	7MH4960-6AA01	7MH4138-6AA00-0BA0	7MH4980-1AA01 7MH4980-2AA01
Type	Non-automatic weighing machines, fill level monitoring of silos, load measuring for industrial lifts and rolling mills, container weighing, platform and crane scales in SIMATIC S7-1200	Belt scales	Non-automatic weighing module for dosing and batching tasks, automatic gravimetric filling instrument, automatic catchweighing instrument in SIMATIC S7-1200	Technology module for the distributed I/O system SIMATIC ET 200SP. Suitable for non-automatic scales in level measurement in silos and bunkers and platform scales	Technology modules for the SIMATIC S7-1500 advanced controller family. Optimally prepared for gravimetric level measurement of silos and hoppers as well as for platform scales
Key features	<ul style="list-style-type: none"> • Can be used stand-alone • High resolution of one million digits 	<ul style="list-style-type: none"> • Can be used stand-alone • Resolution of one million digits • Simulation mode for belt load and/or belt speed • Usable in hazardous applications ATEX zone 2 	<ul style="list-style-type: none"> • Resolution of up to \pm four million parts • Four digital in- and outputs, one analog output on board 	<ul style="list-style-type: none"> • Resolution of up to \pm two million parts • Compact design • "Ready for use" sample application • Scale internal control of freely definable limit values 	<ul style="list-style-type: none"> • Resolution of up to \pm four million parts • Integrated part of TIA portal • Automatic impedance control of the load cells, process, and diagnostic alarms

	SIWAREX CS	SIWAREX U	SIWAREX FTA	SIWAREX FTC
				
Order No.	7MH4910-0AA01	7MH4950-1AA01 one channel 7MH4950-2AA01 two channel	7MH4900-2AA01	7MH4900-3AA01
Type	Basic weighing and force measuring tasks in SIMATIC S7-300 and S7-400	Basic weighing and force measuring tasks in SIMATIC S7-300 and S7-400	Automatic and non-automatic weighing, for production of mixtures, filling, loading, monitoring, checkweighing and bagging in SIMATIC S7-300 and S7-400	Continuous weighing for conveyor scales, solids flowmeters, and loss in weight feeders in SIMATIC S7-300 and S7-400
Key features	<ul style="list-style-type: none"> • Resolution of 65,000 digits • Extensive diagnostic capabilities 	<ul style="list-style-type: none"> • Resolution of 65,000 digits • Space saving through use of two-channel version for two scales 	<ul style="list-style-type: none"> • Resolution of 16 million digits • Legal for trade • Fast dosing with fast communication 	<ul style="list-style-type: none"> • Resolution of 16 million digits • Application in Ex-Zone 2 • Extensive diagnostic functions

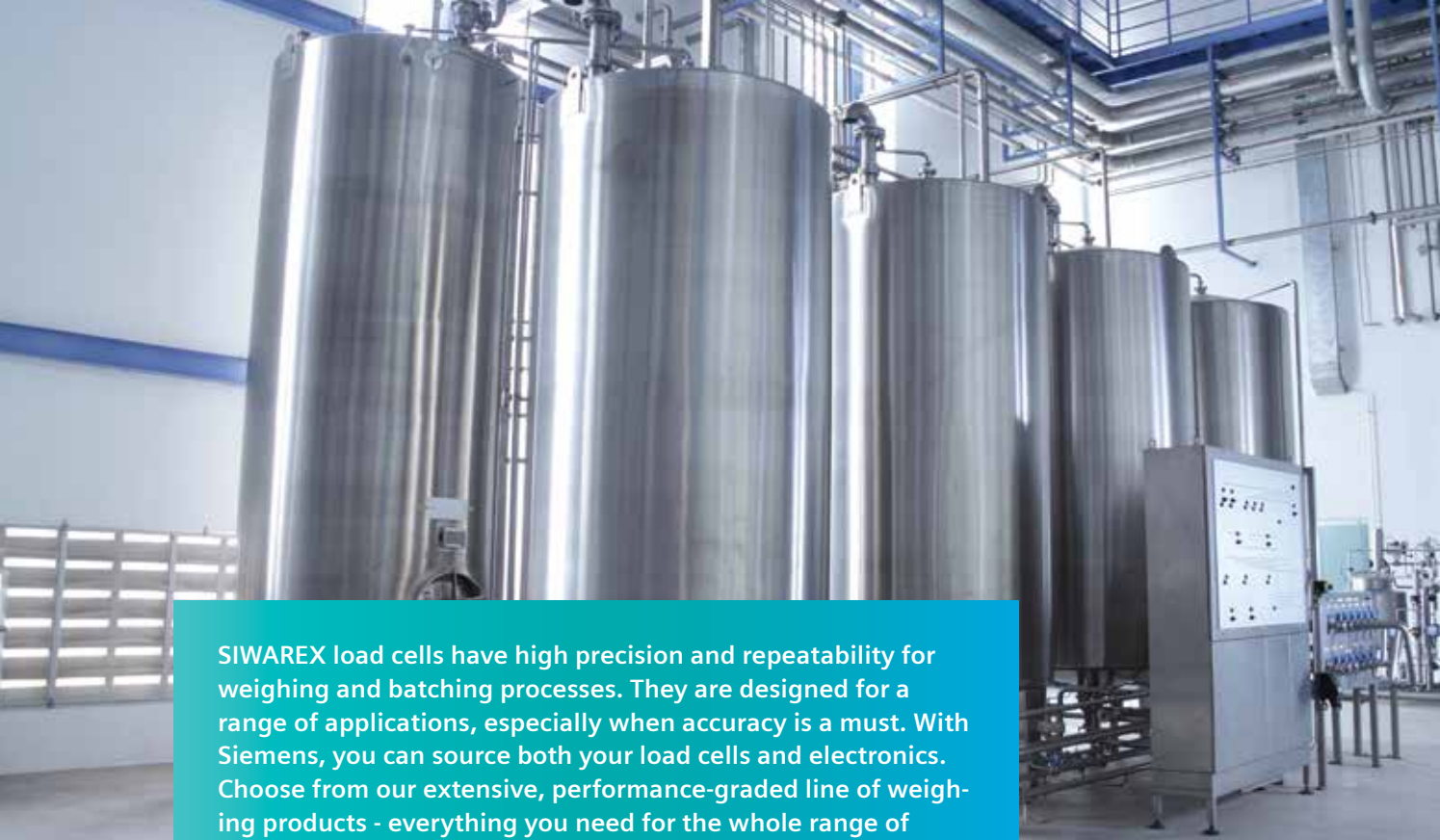

SIWAREX load cells have high precision and repeatability for weighing and batching processes. They are designed for a range of applications, especially when accuracy is a must. With Siemens, you can source both your load cells and electronics. Choose from our extensive, performance-graded line of weighing products - everything you need for the whole range of tasks in your industry.

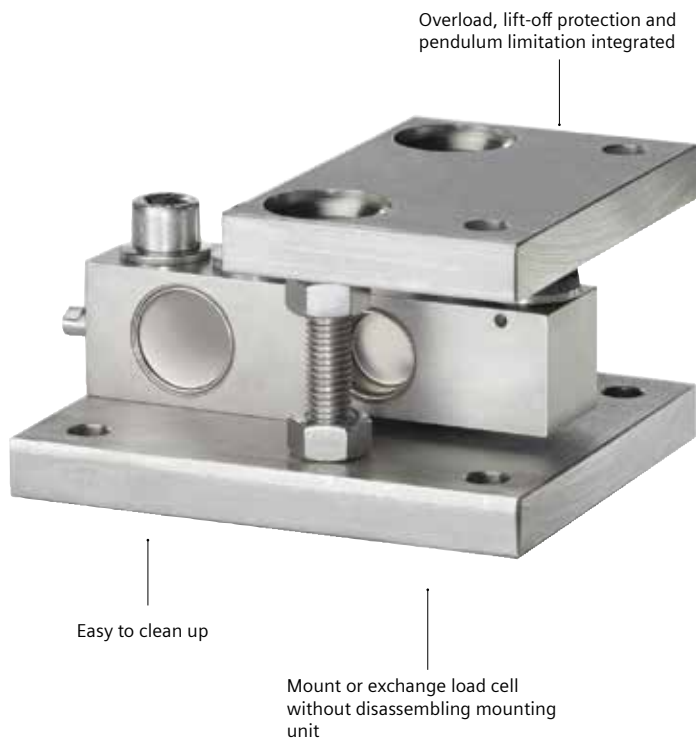







SIWAREX load cells are ideal in almost any industrial sector - food-processing, steel-making, chemical and pharmaceutical, to name a few.

With the diverse construction types and comprehensive, graded load classes ranging from 3 kilograms to 500 tons, you are sure to find the right load cell for your application.







Avoid installation troubles by complementing your load cells with SIWAREX mounting accessories. Mounting accessories get you ready for operation in the shortest possible period.

Load cells: the foundation of every scale

SIWAREX load cells

	SIWAREX WL230 BB	SIWAREX WL230 SB	SIWAREX WL250	SIWAREX WL260	SIWAREX WL270	SIWAREX WL280	SIWAREX WL290
							
Order no	7MH5106-...	7MH5107-...	7MH5105-...	7MH5102/03/04/16/17/18/20/23	7MH5108/10/14-...	7MH5113-...	7MH5122-...
Type	Bending beam for platform and hopper scales	Shear beam load cell for platform and hopper scales, overhead track scales	S-type load cell for tension and pressure applications, hanging and hopper scales, hybrid scales	Single point load cell for platform scales	Compression load cell for hopper scales, overhead truck scales, vehicle scales	Ring torsion load cell for platform and hopper scales, conveyor belt scales, roller table scales	Double shear beam load cell for big platform, hopper, and vehicle scales
Key features	<ul style="list-style-type: none"> Rated load from 10 kg to 500 kg C3 to OIML R60 IP68 	<ul style="list-style-type: none"> Rated load from 0.5 to 5t C3 to OIML R60 IP68 	<ul style="list-style-type: none"> Rated load from 50 kg to 10 t C3 to OIML R60 IP67 	<ul style="list-style-type: none"> Rated load from 3 kg to 200 kg C3 to OIML R60 IP66, IP67, IP68, IP69K 	<ul style="list-style-type: none"> Rated load from 2.8 t to 500 t C3 to OIML R60 IP66/IP68 	<ul style="list-style-type: none"> Rated load from 60 kg to 60 t C3 to OIML R60 IP66/IP68 	<ul style="list-style-type: none"> Rated load from 13.6 t to 34 t C3 to OIML R60 IP67

SIWAREX mounting units and junction boxes

	SIWAREX WL230 BB	SIWAREX WL230 SB	SIWAREX WL270 CP	SIWAREX WL270 K	SIWAREX WL280 RN	SIWAREX WL290	Junction boxes
							
Order No.	7MH5707-...	7MH4133-... 7MH5707-...	7MH5708-... 7MH5710-...	7MH3115-...	7MH4130-... 7MH4125-... 7MH4115-..	7MH5722-...	7MH4710-...
Type	Base plate and elastomer bearing for platform and hopper scales, roller table scales	Compact mounting unit for platform and hopper scales, roller table scales	Compact mounting unit for hopper scales	Self-aligning bearing for hopper scales, silo scales	Compact installation unit and arm, Elastomer bearings for platform and hopper scales, roller table scales	Mounting unit for platform and hopper scales	Junction boxes to connect several load cells to one SIWAREX weighing system
Key features	<ul style="list-style-type: none"> Rated load from 500 kg to 5 t Material: stainless steel and neoprene 	<ul style="list-style-type: none"> Rated load from 10 kg to 500 kg, 0.5 t to 5 t Material: stainless steel 	<ul style="list-style-type: none"> Rated load from 2t to 50 t, 100 t Material: stainless steel 	<ul style="list-style-type: none"> Rated load from 2.8 t to 500 t Material: steel, enameled 	<ul style="list-style-type: none"> Rated load from 60 kg to 60 t Material: stainless steel and neoprene 	<ul style="list-style-type: none"> Rated load from 13,6 kg to 34 t Material: Nickel-plated steel 	<ul style="list-style-type: none"> Material: aluminium or stainless steel IP66

Weighing modules with optional stand-alone displays

The new SIWAREX WT231 weighing terminals for non-automatic scales and SIWAREX WT241 for conveyor belt scales combine the proven quality of Siemens components in a single device: a high-performance electronic weighing system and a Siemens Touch Panel with an application-specific user interface.



Thanks to the integrated terminal panel for up to four load cells, a separate junction box is not required. The two weighing terminals can be quickly and easily implemented as a stand-alone solution. They can also be integrated into all common controller environments via an RS485 Modbus RTU interface.



SIWAREX WT231
Optional: Stand-alone display



SIWAREX WT241
Optional: Stand-alone display

	SIWAREX WT231	SIWAREX WT241
		
Order No.	7MH4965-2AA01	7MH4965-4AA01
Applications	Platform scales, silo and bunker weighing, scales in hazardous areas, force measurement	Conveyor belt scale applications
Key features	<p>Resolution: Up to \pm four million parts</p> <p>Measurement rate: 10 ms/100 Hz</p> <p>Interfaces:</p> <ul style="list-style-type: none"> • RS485 Modbus RTU • 4 digital inputs (floating) • 4 digital outputs (floating) • 1 analog output (0/4...20 mA) <p>Connections:</p> <ul style="list-style-type: none"> • 3 EM16 EMI-proof cable gland for load cells • 1 EM16 EMI-proof cable gland for load cells • 4 16 mm drill holes with dummy plugs • 1 power supply connection • 1 ground connection • Mounting bracket for wall mounting <p>Dimensions: 263.5 mm x 185 mm x 95 mm</p>	

Our integrators display primary speed and load values, as well as derived values of rate and total on the LCD, or output the information as analog mA output, alarm relay, or remote totalizer or through several industrial communications protocols.



	Milltronics BW500/L	Milltronics BW500	Milltronics SF500
	Basic belt scale applications	Full feature belt scale and weighfeeder applications	Full feature flowmeter applications
Order No.	7MH7152	7MH7152	7MH7156
Key features	<ul style="list-style-type: none"> • 7 different languages supported • 7 different industrial communications available • 2 programmable relays 	<ul style="list-style-type: none"> • 2 analog inputs, 3 analog outputs • PID control and batching functions • 5 programmable relays 	<ul style="list-style-type: none"> • 7 different languages supported • 7 different industrial communications available • 5 programmable relays

Belt scales: the first choice for dynamic weighing systems

Imagine a belt scale with drop-in installation. Without any moving parts. With corrosion-resistant load cells, quick calibration, and very little maintenance. And did we mention more approvals than any other scale in the world?

The internationally award-winning Siemens Milltronics MSI features simple, proven construction built around the most effective load cell technology on the planet. Structurally sound for the most demanding applications, the scale's unique design ensures optimum performance in harsh conditions and dusty environments.

Need even greater accuracy? The combination of two MSI belt scales in tandem - otherwise known as Siemens Milltronics MMI - can achieve ± 0.25 percent accuracy for critical monitoring such as custody transfer applications.

Siemens belt scales are built for your industry, for your application. Imagine.

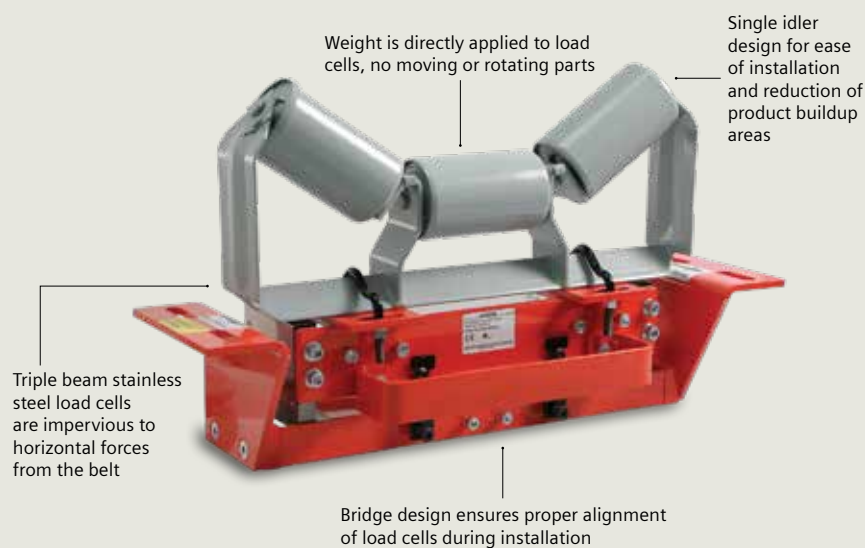







	Milltronics MMI	Milltronics MSI	SITRANS WB300
	High accuracy and demanding applications		
Order No.	7MH7122	7MH7122	7MH7xxx (on request)
Key features	<ul style="list-style-type: none"> • ± 0.25 % accuracy over a 5:1 rate range (MMI-2) • ± 0.125 % accuracy over a 5:1 rate range (MMI-3) • Industry leading performance 	<ul style="list-style-type: none"> • ± 0.5 % accuracy over a 5:1 rate range • Triple beam load cells for optimum performance • More approvals than any other belt scale in the world 	<ul style="list-style-type: none"> • ± 2 % accuracy over a 3:1 rate range • Shear beam load cells reliable performance • Heavy duty design suited for pan conveyors

	Milltronics MLC	Milltronics WD600	SITRANS WB310	Milltronics MUS	Milltronics MCS
	Chemical, recycling, and food applications			General purpose non-critical applications	
Order No.	7MH7126	7MH7185	7MHxxx (on request)	7MH7123	7MH7125
Key features	<ul style="list-style-type: none"> • ± 0.5 to 1% accuracy over a 4:1 rate range • Precision idler for maximum resolution • Triple beam load cells for optimum performance 	<ul style="list-style-type: none"> • ± 0.5 to 1% accuracy over a 4:1 rate range • Long weighdeck for increased retention time • Compact load cell design for easy conveyor intergration 	<ul style="list-style-type: none"> • ± 5 % accuracy over a 4:1 rate range • Counterbalanced pan for maximum resolution • Triple beam load cells for optimum performance 	<ul style="list-style-type: none"> • ± 0.5 to 1% accuracy over a 4:1 rate range • Modular design for easy installation • Standard and heavy duty option for harsh industries 	<ul style="list-style-type: none"> • ± 0.5 to 1% accuracy over a 4:1 rate range • Triple beam load cells for optimum performance • Low profile for easy conveyor integration

Belt scale accessories: calibration made easy

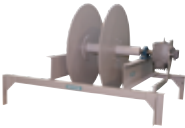
Belt scale accessories give you effective stock control, reduce transaction costs, and protect your assets. Mechanical calibration aids such as hoisting systems are used for test weights and calibration chains. Siemens belt scale accessories complete the package - everything you need for the whole range of belt scale-related tasks.

	Milltronics MWL weight lifter	Milltronics test chains	Test chain storage reels	Termination boxes
				
	Belt scale calibration			J-boxes
Order No.	7MH7218	7MH7161	7MH7163	7MH7723-1ND, 7MH7723-1NE
Description	Calibration weight lifter for use with MSI, MMI, MUS, and MCS belt scales. MWL safely applies and stores calibration test weights for belt loading simulation	Calibration test chains for dynamic belt loading simulation for Milltronics belt scales. All test chains are bushed and minimum length is 1.2 m (4 ft)	Calibration test chain storage reels for motor driven chain application and storage. All test chain storage reels come with a geared brake motor	Connect belt scale and speed sensor to a single point on the conveyor
Key features	<ul style="list-style-type: none"> • Large mechanical advantage for ease of manual calibration • Secured test weights for reliable verification • Safety lock for storage during conveying 	<ul style="list-style-type: none"> • Precision machined for optimum calibration • Dynamic loading simulation • High test loading 	<ul style="list-style-type: none"> • Safe storage and application of chains • Brake motor for safety back up control • Dual compartment options for linear loading comparisons 	<ul style="list-style-type: none"> • Ease of belt scale connectivity to integrator • Corrosion resistant stainless steel option • Fast troubleshooting with complete field scale access

Speed sensors: reliable conveyor monitoring

Speed sensors play a key role in any belt scale measurement system - the overall system accuracy depends on a reliable speed signal. Siemens offers shaft-driven and belt-driven speed sensors that are easy and economical to install, providing reliable and accurate signals.

	Milltronics TASS	Milltronics RBSS	SITRANS WS300	Bend pulleys
				
	Return belt mounting		Shaft mounted	Conveyor frame mounted
Order No.	7MH7131	7MH7134	7MH7177	7MH7170/1, 7MH7187/8
Description	Compact, low-profile, wheel-driven return belt speed sensor	High resolution, wheel-driven return belt speed sensor	Compact low to high resolution, pulley shaft-driven speed sensor	Self cleaning, drum and lagged drum pulleys
Key features	Compact low profile design	<ul style="list-style-type: none"> • Heavy duty design and wheel assembly for harsh conditions • Protected sensor and targets from falling debris • High resolution speed sensing 	<ul style="list-style-type: none"> • Compact, rugged design for shaft mounting • Low to high resolution options • Aluminum and stainless steel construction options 	<ul style="list-style-type: none"> • Pre-drilled mounting for SITRANS WS300 speed sensor • Creates installation room for belt scale

Solids flowmeters: consistent and continuous metering

SITRANS dry solids flowmeters enhance process control, giving you improved product quality and a better bottom line. Our flowmeters provide continuous in-line weighing of dry bulk solids with accurate, repeatable results.

SITRANS solids flowmeters are heavy-duty and low maintenance. They have a totally enclosed design to eliminate product waste or contamination and reduce plant maintenance. Since the units are dust tight, they create a healthier work environment, especially when hazardous substances are present.

They easily manage materials ranging from puffed wheat to iron ore. They are unaffected by product buildup as they only sense the horizontal movement of product impact.



	SITRANS WF330	SITRANS WF200	SITRANS WF100	SITRANS WF340	SITRANS WF250	SITRANS WF350
						
	Versatile		Compact		Air slide applications	
Order No.	7MH7102	7MH7115	7MH7186	7MH7104	7MH7115	7MH7106
Key features	<ul style="list-style-type: none"> Flow rates up to 300 tph Dust tight enclosure High temp materials 	<ul style="list-style-type: none"> Flow rates up to 900 tph Dust tight enclosure Large particle sizes 	<ul style="list-style-type: none"> Flow rates up to 200 tph Dust tight enclosure 	<ul style="list-style-type: none"> Flow rates up to 300 tph Dust tight enclosure High temp materials 	<ul style="list-style-type: none"> Flow rates up to 900 tph Dust tight enclosure Unique solution 	<ul style="list-style-type: none"> Flow rates up to 300 tph Dust tight enclosure Unique solution





Weighfeeders: crucial weighing, made to order

SITRANS weighfeeders are configured to meet your application needs, guaranteeing the perfect fit. Ranging from light- to heavy-duty, these weighfeeders deliver fast, reliable, and uninterrupted service no matter what your application. Virtually maintenance-free construction delivers unmatched performance from food processing to aggregates and everything in between.

Weighfeeders are indispensable when automated production processes require continuous in-line weighing and feeding.

Flanged belting is available on most models so that product is not lost during transport. The height of the flange depends on model and application. Belt widths and conveyor lengths are made to measure for the required solution.

	SITRANS WW100	SITRANS WW200
		
Order No.	7MH7180	7MH730x
Key features	<ul style="list-style-type: none"> • High accuracy for low flowrates • Large range due to Servodrive • Short delivery time 	<ul style="list-style-type: none"> • Designed for food industry • Easy cleaning due to slider bars for belt transport • Various options and designs available



Process protection

Process protection devices are like an insurance policy for your plant, except better. These devices warn you of problems before they occur or before they develop into something more serious.

Motion sensors, which let you know if machinery is going too fast, too slow, or has stopped altogether. And acoustic sensors: protecting your valuable machinery and equipment, detecting subtle noises that you may not hear over the noise of the plant.

	Milltronics MFA 4p	SITRANS WM100	SITRANS AS100	SITRANS CU02
				
	Motion detection		Flow detection	
Order No.	7MH7144	7MH7158	7MH7560	7MH7562
Description	Highly sensitive single setpoint motion sensor system used with MSP probes	Heavy-duty stand-alone zero-speed alarm switch	Acoustic sensor detects high frequency emissions from friction or the impact of dust, powders, and granules and solids in motion	Operates with the SITRANS AS100 to provide reliable continuous protection for bulk solids flow; two relays are fully programmable
Key features	<ul style="list-style-type: none"> • 2 relays • Rugged probe design • Industry leading 4" (100 mm) sensor to target gap 	<ul style="list-style-type: none"> • 1 relay • Rugged probe design • Industry leading 4" (100mm) sensor to target gap 	<ul style="list-style-type: none"> • Non-invasive material detection • Compact design • Stainless steel construction for corrosion resistance 	<ul style="list-style-type: none"> • 2 programmable relays • Compact design • Local user programming and display

Remote monitoring and displays

Your business, anywhere: from a simple display to a virtual web monitoring solution, Siemens SITRANS RD family is a window into your weighing operations.

SITRANS RD300 gives you multiple sets of data from dual inputs, offering simple control and flexible output options. Mount it in a convenient location and easily keep an eye on your process with the display's easy-to-read, bright LEDs.



SITRANS RD200/100

	SITRANS RD100	SITRANS RD200	SITRANS RD300
	Loop powered	Universal	Full featured
Order No.	7ML5741	7ML5740	7ML5744
Type	2-wire loop-powered enclosed remote digital display for process instrumentation	Universal input, panel mount, remote digital display for process instrumentation	Dual-line, panel mount, remote digital display for process instrumentation
Key features	<ul style="list-style-type: none"> • 2-wire loop-powered • Two-step configuration • Intrinsically Safe, non-incendive • Serviceability without loop interruption • Factory calibrated 	<ul style="list-style-type: none"> • Easy to read in all conditions • Temperature and process meter • Software supports monitoring and configuration • Alarm indication and process control • Provides power to instrument • Modbus RTU output 	<ul style="list-style-type: none"> • Easy to read, dual-line display • 32-point linearization and square root function • Nine digit totalizer • Flexible outputs with up to eight relays and eight digital I/O for process control alarming • Modbus RTU output • Multi-pump alternation control • Software supports monitoring and configuration

Training in Karlsruhe

The training center in Karlsruhe provides a wide range of industrial scales across nearly 200 square meters. From conveyor belt scales to dosing and bagging, a wide variety of SIWAREX application possibilities can be seen in action. Moreover, the training center has a spacious training room and numerous training models.

In addition to presentation rooms, Siemens offers an extensive range of standard training courses for weighing technology. Individual training can be arranged as well, targeted to a specific application.

For this purpose, the training center offers customized “hands-on” training, demonstrations, and tests of applications or products.

The facilities can be used for individual training courses to convince potential customers of the SIWAREX benefits. Various applications can be extensively tested with the help of our SIWAREX experts.

The following training topics are offered:

- Weighing systems, conveyor belt scales, dosing belt scales
- Dynamic weighing systems
- SIWAREX sensor systems and electronics
- Static weighing systems

You can find more details about SIWAREX training at Siemens Industry Training

[siemens.de/sitrain](https://www.siemens.de/sitrain)

info@sitrain.com





Sales and support

Custom engineering

Siemens provides custom-engineered products to solve your special application needs. From material compatibility challenges to unique size requirements, Siemens custom engineering team can help.

Service around the world

Plants must function reliably at all times. Efficient and effective process instrumentation and analytics are an indispensable requirement to this end. You also need to be certain of fast and competent service from your supplier. Siemens is a global company that reacts locally. Whether you require consulting, quick delivery, or installation of new devices, the Siemens network of specialists is available to you around the world, wherever your location.

Service around the clock

Our online support system offers rapid, comprehensive assistance regardless of time or location. From product support to service information, Siemens Industry online support is your first choice - around the clock, 365 days a year.

[siemens.com/automation/service&support](https://www.siemens.com/automation/service&support)

Totally Integrated Automation

Products from the controller level to the field level

With Totally Integrated Automation (TIA), Siemens is the only provider of an end-to-end integrated portfolio of products and systems for the automation of the entire production workflow. From the goods receiving area to the finished goods warehouse.

Totally Integrated Automation reduces the complexity of the automation solution and enables what really counts: the practical combination of optimally coordinated individual components without interface problems.

Totally Integrated Automation integrates not only the production process but all parts of the company from the field level to the management level. The result: a perfectly coordinated overall concept that enables higher productivity.

Communication flexibility

Siemens TIA approach offers ease of connection to a DCS system such as SIMATIC PCS 7 using industrial standards. Siemens provides communication flexibility, supporting:

- SIMATIC PDM
- PROFIBUS
- HART
- FOUNDATION Fieldbus
- Model 375/475 HART field communicator and Emerson AMS
- SmartLinx (cards are available for PROFIBUS DP, Modbus RTU, and DeviceNet)
- FDT Software via SITRANS DTM

Efficient interoperability of all automation components

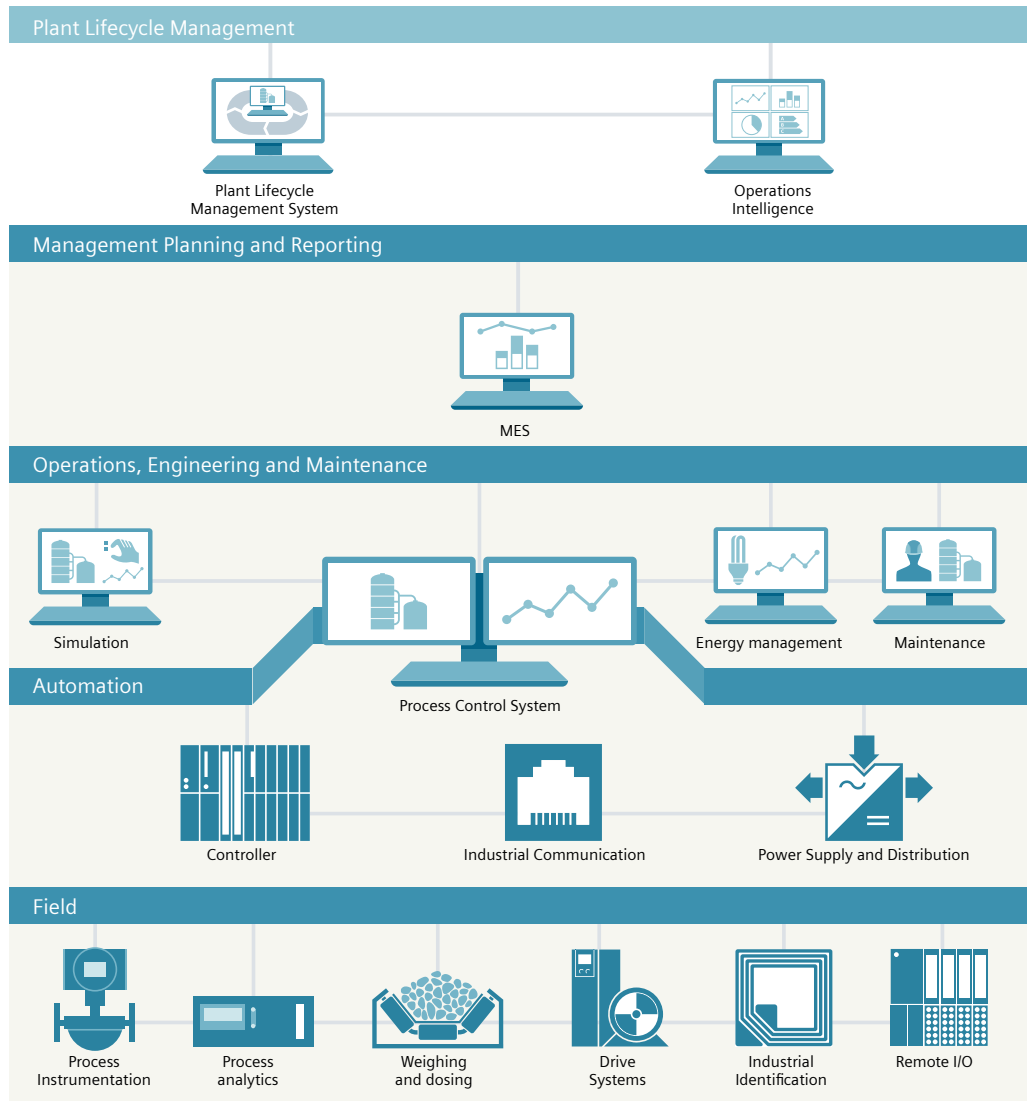

Added value in all automation tasks



Measuring everything that matters:

usa.siemens.com/pi

Siemens Process Instrumentation offers best-in-class measurement and seamless integration into your automation system. We are the total solution provider for flow, level, pressure, temperature, weighing, positioners and more.

Scan to
explore the
PIA Life Cycle
Portal



Legal Manufacturer

Siemens Industry, Inc.
100 Technology Drive
Alpharetta, GA 30005
United States of America

Telephone: +1 (800) 365-8766
usa.siemens.com/pi

Order No. PIBR-B10240-0322

This document contains a general description of available technical options only, and its effectiveness will be subject to specific variables including field conditions and project parameters. Siemens does not make representations, warranties, or assurances as to the accuracy or completeness of the content contained herein. Siemens reserves the right to modify the technology and product specifications in its sole discretion without advance notice.