



Oval Wheel Flow Meter for viscous liquids



measuring
•
monitoring
•
analysing

OVZ



Model: OVZ



Model: OVZ
with compact electronics



Model: OVZ

- Measuring ranges:
0.3 - 8 ... 1.6 - 40 l/min liquid
- Measuring accuracy: $\pm 2.5\%$ f.s.
- p_{\max} : 40 bar; t_{\max} : 80 °C
- Viscosity range: 10 - 800 mm²/s
- Connection: G ¼ ... G ¾ female
- Material:
POM, PMMA, PSU, aluminium
- Output: pulses

S4



KOBOLD companies worldwide:

ARGENTINA, AUSTRALIA, AUSTRIA, BELGIUM, BULGARIA, CANADA, CHILE, CHINA, COLOMBIA, CZECHIA, EGYPT, FRANCE, GERMANY, GREAT BRITAIN, HUNGARY, INDIA, INDONESIA, ITALY, MALAYSIA, MEXICO, NETHERLANDS, PERU, POLAND, REPUBLIC OF KOREA, ROMANIA, SINGAPORE, SPAIN, SWITZERLAND, TAIWAN, THAILAND, TUNISIA, TURKEY, USA, VIETNAM

KOBOLD Messring GmbH
Nordring 22-24
D-65719 Hofheim/Ts.
Head Office:
+49(0)6192 299-0
+49(0)6192 23398
info.de@kobold.com
www.kobold.com

Application

The model OVZ oval wheel flow meters are used to measure, monitor and meter viscous liquids. The flow meters function independent of viscosity in the viscosity range between 10 and 800 mm²/s. A maximum pressure loss of 1 bar has been defined at the factory.

This results in different measuring ranges for different viscosities. The oval gearwheels are manufactured from highquality plastic.

Function

The OVZ oval wheel meter is a positive-displacement flow meter. The measuring element comprises two toothed

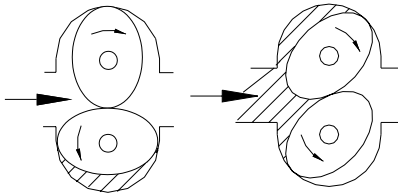

precision oval gearwheels, which are driven by the liquid and thus roll together. A fixed quantity of liquid is transported through the chambers for every turn of the oval-wheel pair. Permanent magnets or stainless steel pins are embedded in the oval gearwheels. The rotary motion is converted to a pulse signal by electrical sensors externally fitted to the measuring chamber. The pulse count is a measure of the flow rate. The signals are evaluated by downstream electronics (optional).

Technical Details

Viscosity range:	10...800 mm ² /s (option: 1000 mm ² /s)
Ambient temperature:	-10°C...+60°C
Medium temperature:	-10°C...+80°C
Max. pressure:	OVZ-..1, OVZ-..2:10 bar OVZ-..3, OVZ-..4:16 bar OVZ-..5:40 bar
Accuracy:	± 2.5% f. s.
Filter mesh size:	max. 30 µm
Material:	combination/case/cover OVZ-..1.. / POM/POM OVZ-..2.. / POM/PMMA OVZ-..3.. / aluminium /PMMA OVZ-..4.. / aluminium /PSU OVZ-..5.. / aluminium /aluminium ovals wheels: POM axles: stainless steel 1.4301 O-rings: NBR, option FPM, EPDM
Contactors:	oxide ceramic magnets or stainless steel
Frequency range:	0.3-9 Hz...2-57 Hz
Protection:	IP 65 (..I401, -I302, -I303, ..L 443, .. Z 3x0) IP 67 (all others)

Electronics

● Frequency output (...I401; ...I302; ...I303)

Power supply: 5-24 V_{DC}
 Power consumption: typically 10 mA
 Pulse output: Hall effect sensor NPN, asymmetrical, open collector, max. 15 mA
 Electr. connection: connector socket DIN 43650 (...I401)
 aluminium adapter box with cable connection (...I302)
 aluminium cover box with circular connector M12x1 (...I303)

● Frequency output (...I304)

Power supply: 18-30 V_{DC}
 Power consumption: typically 10 mA
 Pulse output: PNP, asymmetrical, open collector, max. 120 mA
 Electr. connection: 2 m PVC cable

● Frequency output (...I305)

Power supply: nominal 8.2 V_{DC}
 Pulse output: Namur, asymmetrical, max. approx. 3.5 mA (typ. 0.5 mA)
 Electr. connection: 2 m PVC cable

● Frequency output (...F300)

Power supply: 12-28 V_{DC}
 Power consumption: 10 mA
 Pulse output: PNP, open collector, max. 25 mA
 Electr. connection: connector M12x1

● Frequency output with frequency divider (...F3X0)

Power supply: 24 V_{DC} ±20%
 Power consumption: 15 mA
 Pulse output: PNP, open collector, max. 25 mA
 Electr. connection: connector M12x1
 Divisional factor: acc. to customer specification

● Analogue output (...L303; ...L343, ...L443)

Power supply: 24 V_{DC} ±20%
 Output: 4-20 mA, 0-20 mA, 3-wire
 Max. load: 500 Ω
 Electr. connection: connector M12x1 or DIN 43650
 Option: plug-on display AUF-3000 (with DIN connector only)

● Compact electronics

Display: 3-digit LED
 Analogue output: (0)4...20 mA adjustable, max. 500 W
 Switching outputs: 1 (2) semiconductor PNP or NPN factory setting
 Contact operation: N/C, N/O programmable
 Setting: via 2 keys
 Power supply: 24 V_{DC} ±20%, 3-wire, appr. 100 mA
 Electr. connection: connector M12x1

● Pointer indication with analogue output

Housing: aluminium
 Indication: moving coil instrum., 240° indication
 Power supply: 24 V_{DC} ±20%
 Output: 0-20 mA or 4-20 mA, 3-wire
 Max. load: 250 Ω
 Electr. connection: connector M12x1

Electrical Connection

OVZ-...I401

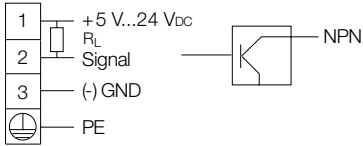

OVZ-...I302

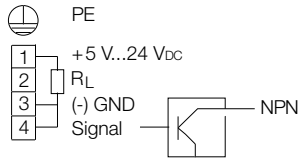

OVZ-...I303

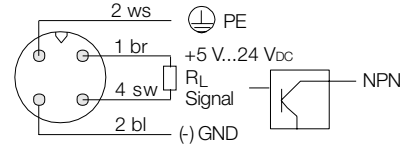

OVZ-...I304

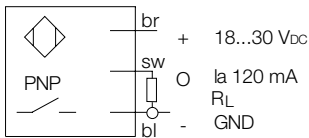

OVZ-...I305

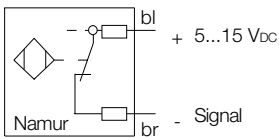

OVZ-...L443

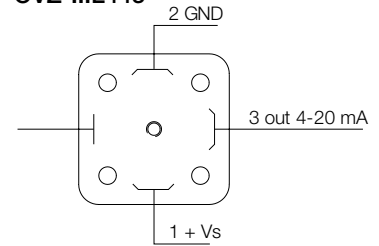

OVZ-..F., OVZ-..Z., OVZ-..L3..

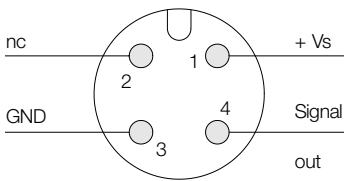

OVZ-..C..

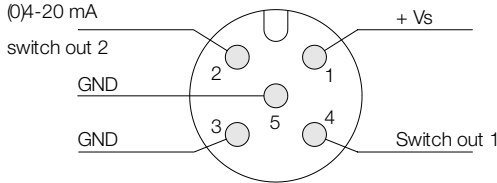

$R_L = 2,4 \dots 100 \text{ k}\Omega$

Pressure Losses (POM plastic housing)

OVZ-02...

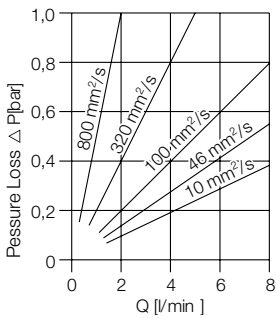

OVZ-04...

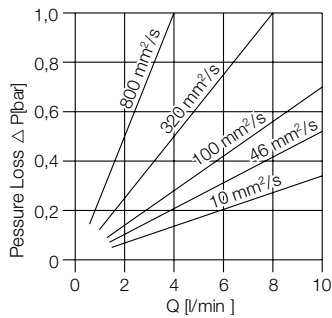

OVZ-15...

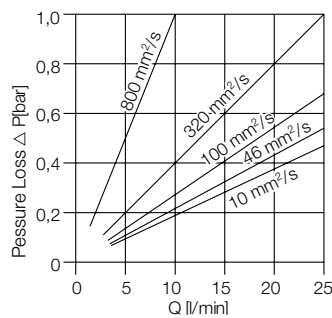

OVZ-30...

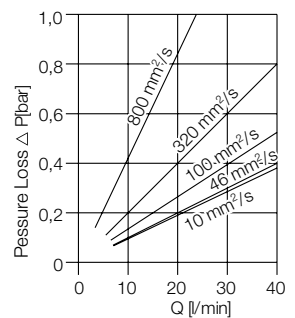

Pressure Losses (aluminium housing)

OVZ-02...

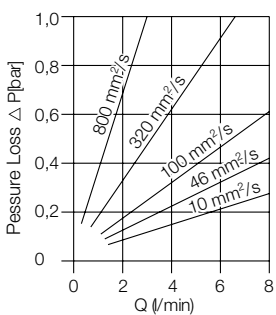

OVZ-04...

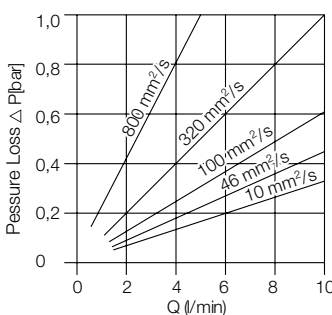

OVZ-15...

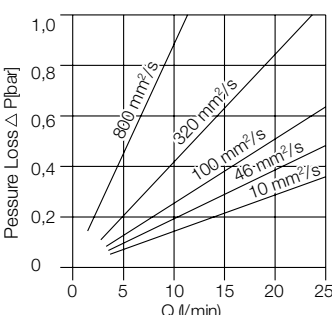

OVZ-30...

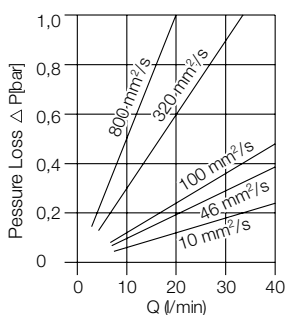



Oval Wheel Flow Meter for Viscous Liquids Model OVZ

Order Details (POM plastic housing) (Example: OVZ-02 1 G2 N I401)

Rated measuring range (l/min) ¹⁾ (for different viscosities)				Imp./ Liter ²⁾⁴⁾	Model	Material/ cover	Connection	Gaskets	Electrical transducer
10 mm ² /s	100 mm ² /s	320 mm ² /s	800 mm ² /s						
0.3-8.0	0.3-8.0	0.2-5.0	0.1-2.0	408.5	OVZ-02..	..1.. = POM ..2.. = PMMA	..G2.. = G ¼ ..N2.. = ¼" NPT	..N.. = NBR (standard) ..V.. = FPM ..E.. = EPDM	Frequency output ..I401 = Frequency output NPN, connector DIN 43650 ..I302 = Frequency output NPN, cable connection ..I304 = Frequency output PNP, 2 m PVC cable ..I305 = Frequency output Namur, 2 m PVC cable ..F300 = Frequency output PNP, connector M12x1 ..F3X0 = frequency divider adjusted PNP, connector M12x1 Analogue output ..L303 = 0-20 mA output, 3-wire, M12x1 connector ..L343 = 4-20 mA output, 3-wire, M12x1 connector ..L443 = 4-20 mA output, 3-wire, DIN connector Compact electronic³⁾ ..C30R = LED display, 2 x open collector, PNP, connector M12x1 ..C30M = LED display, 2 x open collector, NPN, connector M12x1 ..C34P = LED display, 4-20 mA, 1 x op. coll. PNP, connector M12x1 ..C34N = LED display, 4-20 mA, 1 x op. coll. NPN, connector M12x1 Pointer indication, 240°³⁾ ..Z300 = 240° pointer indication, 0-20 mA, connector M12x1 ..Z340 = 240° pointer indication, 4-20 mA, connector M12x1
0.4-10.0	0.4-10.0	0.3-8.0	0.15-4.0	224	OVZ-04..		..G2.. = G ¼ ..N2.. = ¼" NPT		
1.0-25.0	1.0-25.0	1.0-25.0	0.4-10.0	52.5	OVZ-15..		..G4.. = G ½ ..N4.. = ½" NPT		
1.6-40.0	1.6-40.0	1.6-40.0	0.95-24.0	28	OVZ-30..		..G5.. = G ¾ ..N5.. = ¾" NPT		

¹⁾ Maximum pressure loss at maximum rated flow is 1 bar

²⁾ Hz = Imp./Liter x l/min/60

³⁾ Please specify flow direction in writing

⁴⁾ At the electronic option »frequency output« the actual pulse ratio is stated on the type label



Order Details (aluminium housing) (Example: OVZ-02 3 G2 N I401)

Rated measuring range (l/min) ¹⁾ (for different viscosities)				Imp./ Liter ²⁾⁴⁾	Model	Material/ cover	Connection	Gaskets	Electrical transducer
10 mm ² /s	100 mm ² /s	320 mm ² /s	800 mm ² /s						
0.3-8.0	0.3-8.0	0.2-5.0	0.1-3.0	396	OVZ-02..		..G2.. = G ¼ ..N2.. = ¼" NPT		Frequency output ..I401 = Frequency output NPN, connector DIN 43650 ..I302 = Frequency output NPN, cable connection ..I303 = Frequency output NPN, connector M12x1 ..F300 = Frequency output PNP, connector M12x1 ..F3X0 = frequency divider adjusted PNP, connector M12x1 Analogue output ..L303 = 0-20 mA output, 3-wire, M12x1 connector ..L343 = 4-20 mA output, 3-wire, M12x1 connector ..L443 = 4-20 mA output, 3-wire, DIN-connector Compact electronic³⁾ ..C30R = LED display, 2 x open collector, PNP, connector M12x1 ..C30M = LED display, 2 x open collector, NPN, connector M12x1 ..C34P = LED display, 4-20 mA, 1 x op. coll. PNP, connector M12x1 ..C34N = LED display, 4-20 mA, 1 x op. coll. NPN, connector M12x1 Pointer indication, 240°³⁾ ..Z300 = 240° pointer indication, 0-20 mA, connector M12x1 ..Z340 = 240° pointer indication, 4-20 mA, connector M12x1
0.4-10.0	0.4-10.0	0.4-10.0	0.25-4.5	203	OVZ-04..	..3.. = PMMA ..4.. = PSU ..5.. = Alu	..G2.. = G ¼ ..N2.. = ¼" NPT	..N.. = NBR (standard) ..V.. = FPM ..E.. = EPDM	
1.0-25.0	1.0-25.0	0.9-23.0	0.5-12.5	46.5	OVZ-15..		..G4.. = G ½ ..N4.. = ½" NPT		
1.6-40.0	1.6-40.0	1.3-33.5	0.8-20.0	26	OVZ-30..		..G5.. = G ¾ ..N5.. = ¾" NPT		

¹⁾ Maximum pressure loss at maximum rated flow is 1 bar

²⁾ Hz = Imp./Liter x l/min/60

³⁾ Please specify flow direction in writing

⁴⁾ At the electronic option »frequency output« the actual pulse ratio is stated on the type label

Digital indicators and transducers to this oval wheel flow meter please see »accessories«.

Plug-on display

for model OVZ...L4... (with 4-20 mA output and DIN connector)

Description	Order number
3-digit LED, plug-connection DIN 43 650, 3-wire, power supply with analogue output	AUF-3000

Dimensions OVZ-...I401

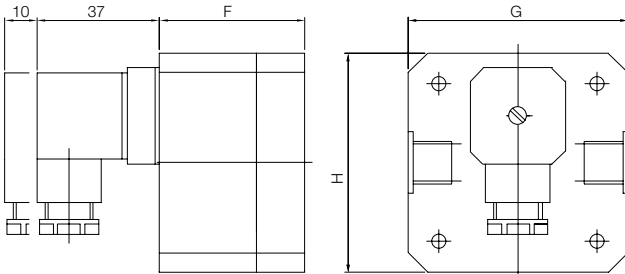

	G [mm]	H [mm]	F [mm]			
			..1..	..2..	..3/4..	..5..
OVZ-02..	68	68	45	45	43.5	41
OVZ-04..	68	68	49	49	47	44.5
OVZ-15..	99	99	71	73	71	66
OVZ-30..	119	119	84.5	87.5	86	79.5

Dimensions OVZ-...I302, OVZ-...I303

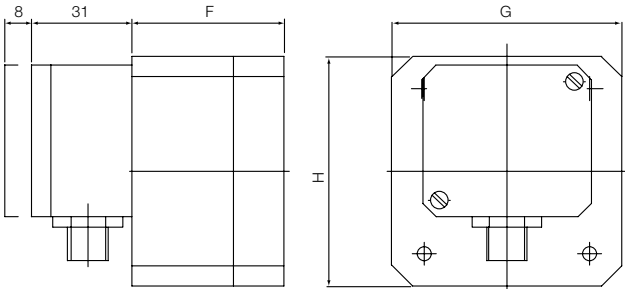

	G [mm]	H [mm]	F [mm]			
			..1..	..2..	..3/4..	..5..
OVZ-02..	68	68	45	45	43.5	41
OVZ-04..	68	68	49	49	47	44.5
OVZ-15..	99	99	71	73	71	66
OVZ-30..	119	119	84.5	87.5	86	79.5

Dimensions OVZ-...I304, OVZ-...I305

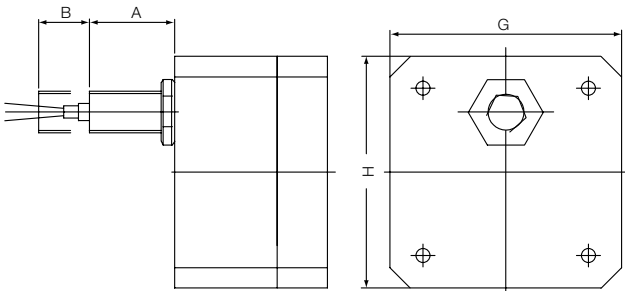

	PNP		NAMUR		PNP/NAMUR	
	A [mm]	B [mm]	A [mm]	B [mm]	G [mm]	H [mm]
OVZ-02..	21.5	13.5	16.5	13.5	68	68
OVZ-04..	21	14	16	14	68	68
OVZ-15..	19	16	14	16	99	99
OVZ-30..	17	18	12	18	119	119

Dimensions OVZ-...L3...

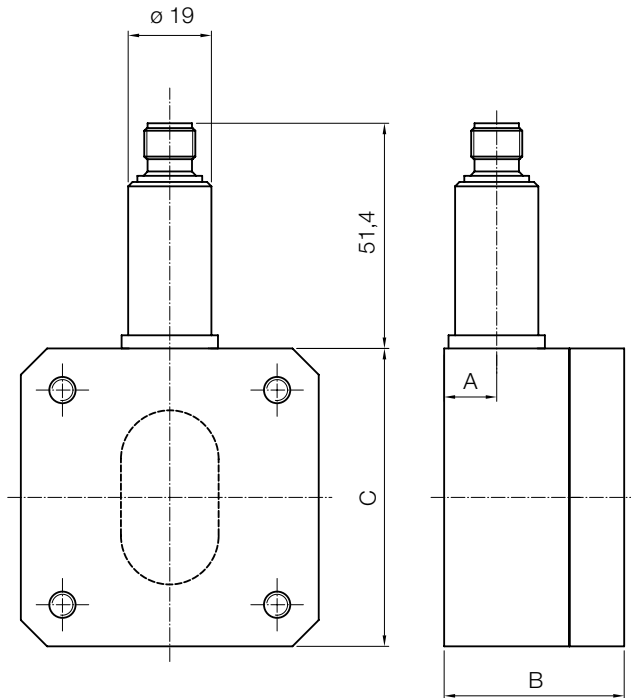

OVZ-...F3...

Dimensions OVZ-...L443 with AUF-3000

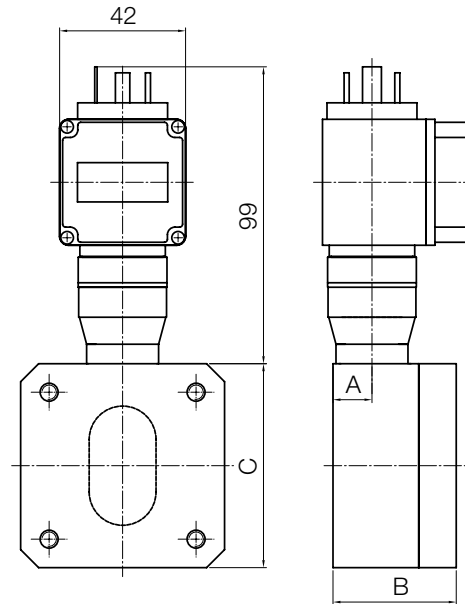

OVZ with frequency or analogue output: overview

Plastic housing (POM)			
Description	Dimension A	Dimension B	Dimension C
OVZ-02 1 = POM	13	45	□ 68
OVZ-02 2 = PMMA	13	45	□ 68
OVZ-04 1 = POM	13.7	49	□ 68
OVZ-04 2 = PMMA	13.7	49	□ 68
OVZ-15 1 = POM	15.65	71	□ 99
OVZ-15 2 = PMMA	15.65	73	□ 99
OVZ-30 1 = POM	17.6	84.5	□ 119
OVZ-30 2 = PMMA	17.6	87.5	□ 119

Aluminium housing (ALU)			
Description	Dimension A	Dimension B	Dimension C
OVZ-02 3 = PMMA	11.5	43.6	□ 68
OVZ-02 4 = PSU	11.5	43.6	□ 68
OVZ-02 5 = ALU	11.5	41.1	□ 68
OVZ-04 3 = PMMA	11.5	47	□ 68
OVZ-04 4 = PSU	11.5	47	□ 68
OVZ-04 5 = ALU	11.5	44.5	□ 68
OVZ-15 3 = PMMA	13.35	71	□ 99
OVZ-15 4 = PSU	13.35	71	□ 99
OVZ-15 5 = ALU	13.35	66	□ 99
OVZ-30 3 = PMMA	15.75	86	□ 119
OVZ-30 4 = POM	15.75	86	□ 119
OVZ-30 5 = PMMA	15.75	79.5	□ 119

Dimensions OVZ-...C3...

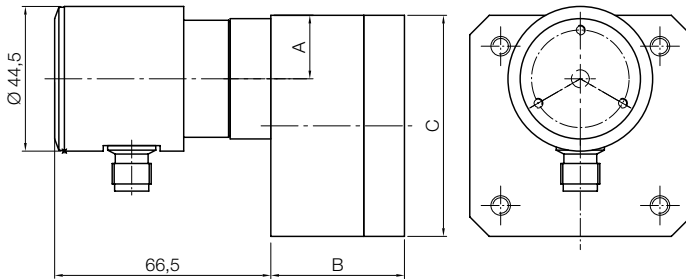

Dimensions OVZ-...Z3...

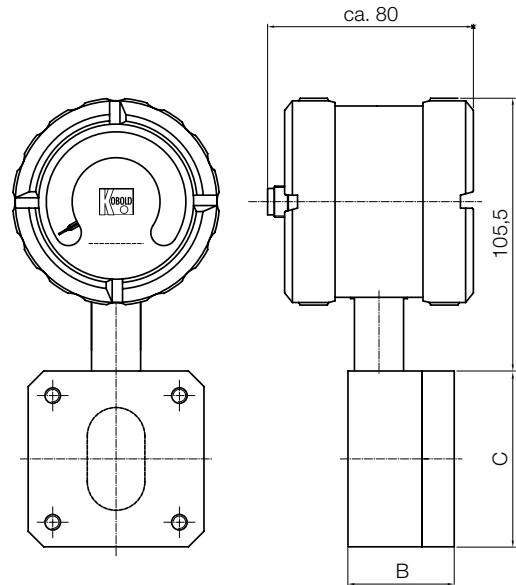

OVZ with compact electronic: overview

Plastic housing (POM)			
Description	Dimension A	Dimension B	Dimension C
OVZ-02 1 = POM	19.525	45	□ 68
OVZ-02 2 = PMMA	19.525	45	□ 68
OVZ-04 1 = POM	16.95	49	□ 68
OVZ-04 2 = PMMA	16.95	49	□ 68
OVZ-15 1 = POM	21.125	71	□ 99
OVZ-15 2 = PMMA	21.125	73	□ 99
OVZ-30 1 = POM	23.2	84.5	□ 119
OVZ-30 2 = PMMA	23.2	87.5	□ 119

Aluminium housing (ALU)			
Description	Dimension A	Dimension B	Dimension C
OVZ-02 3 = PMMA	19.525	43.6	□ 68
OVZ-02 4 = PSU	19.525	43.6	□ 68
OVZ-02 5 = ALU	19.525	41.4	□ 68
OVZ-04 3 = PMMA	19.525	47	□ 68
OVZ-04 4 = PSU	19.525	47	□ 68
OVZ-04 5 = ALU	19.525	44.5	□ 68
OVZ-15 3 = PMMA	21	71	□ 99
OVZ-15 4 = PSU	21	71	□ 99
OVZ-15 5 = ALU	21	66	□ 99
OVZ-30 3 = PMMA	23.025	86	□ 119
OVZ-30 4 = POM	23.025	86	□ 119
OVZ-30 5 = PMMA	23.025	79.5	□ 119