

# Floodlight

## Series 6521/5



www.stahl.de



09678E00

- > The enclosure made of stainless steel V4A, V2A or powder coated sheet steel is available
- > Broad or narrow beam reflectors or asymmetrical lamp fitting
- > Series 6521/5 explosion protected floodlight as spotlight with asymmetrical flat optics reflector

E2



Series 6521/5 explosion protected floodlight for use in explosive gas atmospheres of Zone 2 as well as in areas with combustible dust of Zone 21 and Zone 22.

Zone	ATEX / IECEx					
	0	1	2	20	21	22
For use in			x		x	x

**WebCode 6521C**

# Floodlight

## Series 6521/5

Selection Table

Enclosure	Lamp capacity		Temperature class at Ta =					Order number	Weight kg
	Lampholder	Lamps <sup>1)</sup>	Power	40 °C	55 °C	T <sub>s</sub> max. at Ta = 40 °C	T <sub>s</sub> max. at Ta = 55 °C		
Sheet steel powder coated	E40	HST	250 W	T1	T1	110 °C	125 °C	<b>6521 / 5312-625-123-1-230-50</b>	24.990
			400 W	T1		134 °C		<b>6521 / 5312-640-123-1-230-50</b>	25.590
Stainless steel V2A	E40	HST	250 W	T1	T1	110 °C	125 °C	<b>6521 / 5312-625-123-3-230-50</b>	24.600
			400 W	T1		134 °C		<b>6521 / 5312-640-123-3-230-50</b>	25.200
Stainless steel V4A	E40	HST	250 W	T1	T1	110 °C	125 °C	<b>6521 / 5312-625-123-4-230-50</b>	24.600
			400 W	T1		134 °C		<b>6521 / 5312-640-123-4-230-50</b>	25.200

### Order Number Supplement

Rated voltage	Specify rated voltage	
Note	1) HST	→ High-pressure sodium lamps
	<b>Only lamps of type OSRAM VIALOX-T SUPER can be used.</b>	
	- The floodlights are delivered without lamps, but with mounting brackets. Further mounting accessories must be ordered separately.	
	- Cable gland M20 x 1.5; clamping range $\varnothing$ 6 ... 13 mm (standard) Cable gland M25 x 1.5; clamping range $\varnothing$ 10 ... 17 mm	

### Technical data

Global (IECEX)	
Gas and dust	IECEX TUR 12.0001 Ex nAc IIC T <sup>1)</sup> Ex tb IIIC T <sup>1)</sup> IP66
Europe (ATEX)	
Gas	TÜV 12 ATEX 7173 ⊕ II 3G Ex nAc IIC T <sup>1)</sup>
Dust	TÜV 12 ATEX 7174 ⊕ II 2D Ex tb IIIC T <sup>1)</sup> °C IP66 <sup>1)</sup> See selection table
Certificates and approvals	
Certificates	IECEX, ATEX

# Floodlight

## Series 6521/5



### Technical data







Electrical data			
Rated voltage	220 V ... 240 V AC, 50 Hz		
Rated current	Size 6521/5.	High-pressure sodium vapour lamp* HST *	
		Efficiency	I <sub>N</sub>
	Size 6521/53	250 W 400 W	3.0 A 4.45 A
Power factor cos φ	High-pressure lamps compensated cos φ > 0.9		
Ambient conditions			
Ambient temperature	-40 ... +40 °C for 400W HST -40 ... +55 °C for 250W HST		
Mechanical data			
Degree of protection	IP66 to EN 60529		
Protection class	I (with internal / external PE connection)		
Material	Enclosure	6521/.....-1-.....	Sheet steel powder coated RAL 7032 (pebble-grey)
		6521/.....-3-.....	Stainless steel 1.4301 (V2A)
		6521/.....-4-.....	Stainless steel 1.4404 (V4A)
	Window	Safety glass; resistant to thermal shocks	
Seal	Silicone		
Reflector	Aluminium, anodised		
Enclosure lock	Allen screws, M6, stainless steel Hinged enclosure cover		
Mounting / installation			
Operating position	Horizontal lamp axis		
Cable entry	Standard	1 x M20 x 1.5 cable gland, clamping area Ø 6 ... 13 mm	
		1 x M20 x 1.5 stopping plug 1 x M20 x 1.5 cable entry (with blind plugs)	
Special	specific customer order possible		
Connection option	L1 + N + PE, up to 2.5 mm <sup>2</sup> solid and finely stranded		
	Cage clamp terminals, 2 clamping units		
Mounting	U-shaped holding bracket made of stainless steel, continuously swivelable around the rotary axis of the flood lights.		

E2

# Floodlight

## Series 6521/5

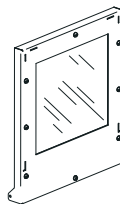
### Accessories and Spare Parts

Designation	Figure	Description	Art. no.	Weight kg
High-pressure sodium lamps HST	 05355E00	Power      Lamp-holder      Voltage      Lighting current		
		250 W      E40      230 V      33200 lm	<b>109131</b>	0.213
		400 W      E40      230 V      56500 lm	<b>109133</b>	0.210
Light visor	 09785E00	Stainless steel; attaches to front cover for 6521/.3	<b>123501</b>	2.460
Baffle screen	 09786E00	Stainless steel; attaches to front cover for 6521/.3	<b>123508</b>	3.390
Mounting base (rotatable)	 09787E00	Stainless steel for all sizes	<b>123495</b>	3.810
Pole mounting attachment	 09788E00	For installation on end of pole (stainless steel)		
		∅ 60 mm	<b>123493</b>	4.430
		∅ 76 mm	<b>123497</b>	5.260
Cover with window	 15083E00	Cover with glass for replacement		
		for 6521/.3 Stainless steel 1.4404 (V4A)	<b>207486</b>	6.500
		for 6521/.3 Stainless steel 1.4301 (V2A)	<b>209188</b>	6.500
Cable gland	 09727E00	Brass, nickel-plated with O-ring		
		M20	<b>109582</b>	0.040
Stopping plug	 09726E00	Brass, nickel-plated with O-ring		
		M20	<b>106132</b>	0.015
		M25	<b>106133</b>	0.024

**Dimensional Drawings** (All Dimensions in mm) - Subject to Alterations

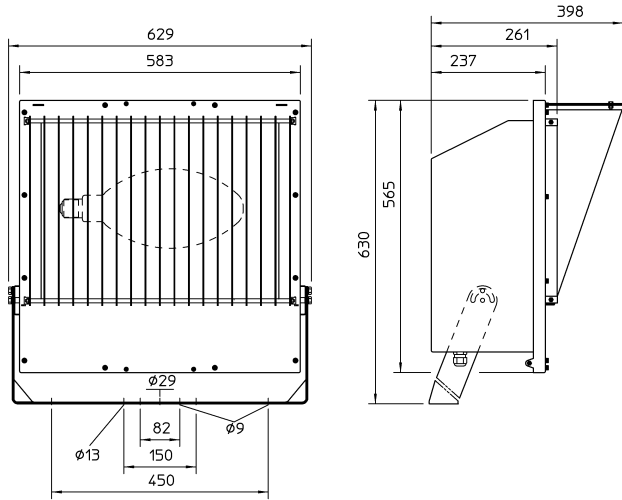

09723E00

1) Shown with baffle screen and light visor, both parts are accessories and are not included in the standard scope of delivery

**Size 3, 6521/3 1)**

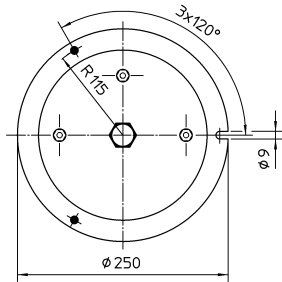
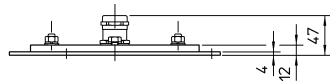

Mounting base (rotatable)

09725E00

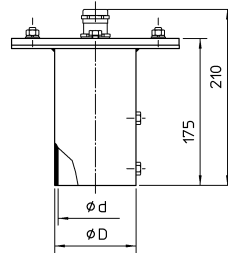

09724E00

Pole mounting attachment

D	d
97	89
89	76
75	60

**Accessories**

We reserve the right to make alterations to the technical data, dimensions, weights, designs and products available without notice. The illustrations cannot be considered binding.