

## Installation and Operation Manual

X -TMF-5964-5850EM-MFC-eng

Part Number: 541B121AHG

November, 2008

# Brooks® Models 5964, 5850EM Mass Flow Controllers



*Model 5964  
Mass Flow Controller  
with D-Connector*



*Model 5850EM  
Mass Flow Controller  
with D-Connector*



*Model 5850EM Downported  
Mass Flow Controller  
with Card Edge*

# Essential Instructions

## Read this page before proceeding!

Brooks Instrument designs, manufactures and tests its products to meet many national and international standards. Because these instruments are sophisticated technical products, you must properly install, use and maintain them to ensure they continue to operate within their normal specifications. The following instructions must be adhered to and integrated into your safety program when installing, using and maintaining Brooks Products.

- Read all instructions prior to installing, operating and servicing the product. If this instruction manual is not the correct manual, please see back cover for local sales office contact information. Save this instruction manual for future reference.
- If you do not understand any of the instructions, contact your Brooks Instrument representative for clarification.
- Follow all warnings, cautions and instructions marked on and supplied with the product.
- Inform and educate your personnel in the proper installation, operation and maintenance of the product.
- Install your equipment as specified in the installation instructions of the appropriate instruction manual and per applicable local and national codes. Connect all products to the proper electrical and pressure sources.
- To ensure proper performance, use qualified personnel to install, operate, update, program and maintain the product.
- When replacement parts are required, ensure that qualified people use replacement parts specified by Brooks Instrument. Unauthorized parts and procedures can affect the product's performance and place the safe operation of your process at risk. Look-alike substitutions may result in fire, electrical hazards or improper operation.
- Ensure that all equipment doors are closed and protective covers are in place, except when maintenance is being performed by qualified persons, to prevent electrical shock and personal injury.

## Pressure Equipment Directive (PED)

All pressure equipment with an internal pressure greater than 0.5 bar (g) and a size larger than 25mm or 1" (inch) falls under the Pressure Equipment Directive (PED). The Directive is applicable within the European Economic Area (EU plus Norway, Iceland and Liechtenstein). Pressure equipment can be traded freely within this area once the PED has been complied with.

- Section 1 of this manual contains important safety and operating instructions related to the PED directive.
- Meters described in this manual are in compliance with EN directive 97/23/EC module H *Conformity Assessment*.
- All Brooks Instrument Flowmeters fall under fluid group 1.
- Meters larger than 25mm or 1" (inch) are in compliance with category I, II, III of PED.
- Meters of 25mm or 1" (inch) or smaller are Sound Engineering Practice (SEP).

## ESD (Electrostatic Discharge)

### CAUTION

**This instrument contains electronic components that are susceptible to damage by static electricity. Proper handling procedures must be observed during the removal, installation or other handling of circuit boards or devices.**

#### Handling Procedure:

1. Power to unit must be removed.
2. Personnel must be grounded, via a wrist strap or other safe, suitable means before any printed circuit card or other internal device is installed, removed or adjusted.
3. Printed circuit cards must be transported in a conductive container. Boards must not be removed from protective enclosure until immediately before installation. Removed boards must immediately be placed in protective container for transport, storage or return to factory.

#### Comments

This instrument is not unique in its content of ESD (electrostatic discharge) sensitive components. Most modern electronic designs contain components that utilize metal oxide technology (NMOS, SMOS, etc.). Experience has proven that even small amounts of static electricity can damage or destroy these devices. Damaged components, even though they appear to function properly, exhibit early failure.

## Installation and Operation Manual

X -TMF-5964-5850EM-MFC-eng

Part Number: 541B121AHG

November, 2008

Brooks® Models 5964, 5850EM

---

Dear Customer,

We appreciate this opportunity to service your flow measurement and control requirements with a Brooks Instrument device. Every day, flow customers all over the world turn to Brooks Instrument for solutions to their gas and liquid low-flow applications. Brooks provides an array of flow measurement and control products for various industries from biopharmaceuticals, oil and gas, fuel cell research and chemicals, to medical devices, analytical instrumentation, semiconductor manufacturing, and more.

The Brooks product you have just received is of the highest quality available, offering superior performance, reliability and value to the user. It is designed with the ever changing process conditions, accuracy requirements and hostile process environments in mind to provide you with a lifetime of dependable service.

We recommend that you read this manual in its entirety. Should you require any additional information concerning Brooks products and services, please contact your local Brooks Sales and Service Office listed on the back cover of this manual or visit [www.BrooksInstrument.com](http://www.BrooksInstrument.com)

Yours sincerely,

Brooks Instrument

*THIS PAGE WAS  
INTENTIONALLY  
LEFT BLANK*

<u>Paragraph Number</u>	<u>Page Number</u>
<b>Section 1 Introduction</b>	
1-1 How to Use This Manual .....	1-1
1-2 Description .....	1-1
1-3 Specifications .....	1-2
<b>Section 2 Installation</b>	
2-1 General .....	2-1
2-2 Receipt of Equipment .....	2-1
2-3 Recommended Storage Practice .....	2-1
2-4 Return Shipment .....	2-2
2-5 Transit Precaution .....	2-2
2-6 Removal from Storage .....	2-2
2-7 In-Line Filter .....	2-3
2-8 Installation .....	2-3
2-9 Electrical Interface .....	2-4
2-10 Operation Procedure .....	2-5
<b>Section 3 Operation</b>	
3-1 Overview .....	3-1
3-2 Connections and Controls .....	3-1
3-3 Theory of Operation .....	3-4
3-4 Features .....	3-6
3-5 Adjustment Potentiometers .....	3-15
3-6 Zero Adjustment .....	3-16
3-7 Calibration Procedure .....	3-17
3-8 Response Adjustment .....	3-22
<b>Section 4 Maintenance</b>	
4-1 Overview .....	4-1
4-2 Troubleshooting .....	4-2
4-3 Gas Conversion Factors .....	4-6
4-4 Orifice Sizing .....	4-10
4-5 Restrictor Sizing .....	4-15
<b>Section A CE Certificate</b>	
CE Certificate of Mass Flow Equipment .....	A-1
<b>Warranty, Local Sales/Service Contact Information .....</b>	<b>Back Cover</b>

Brooks® Models 5964, 5850EM

Figures

<u>Figure Number</u>	<u>Page Number</u>
1-1 MFC/MFM Dimensional Drawing for Model 5964/5850EM with D-Connector and VCR Fittings .....	1-5
1-2 MFC/MFM Dimensional Drawing for Model 5964/5850EM with Card Edge and VCR Fittings .....	1-6
1-3 MFC/MFM Dimensional Drawing for Model 5964/5850EM Downported with D-Connector ....	1-7
1-4 MFC/MFM Dimensional Drawing for Model 5964/5850EM Downported with Card Edge .....	1-8
2-1 Card Edge Connector .....	2-6
2-2 20 Pin Card Edge Connector Ribbon Cable Hookup Diagram .....	2-7
2-3 D-Connector Shielded Cable Hookup Diagram - Voltage I/O Version .....	2-6
2-4 D-Connector Shielded Cable Hookup Diagram - Current I/O Version .....	2-8
2-5 Maximum Allowable Loop Resistance-Current I/O version .....	2-8
2-6 Common Electrical Hookups Current I/O version .....	2-9
3-1 Model 5964/5850EM Components .....	3-2
3-2 Externasly Accessible Adjustments .....	3-3
3-3 Flow Sensor Operational Diagram (VCR™ End Connections Shown) .....	3-4
3-4 Flow Controller System Block Diagram .....	3-4
3-5 Enhanced Response 20 Pin Card Edge PC Board Jumper location and Function .....	3-6
3-6 Standard Response 20 Pin D-Connector PC Board Jumper location and Function .....	3-7
3-7 Enhanced Response 15 Pin D-Connector PC Board Jumper location and Function .....	3-8
3-8 Standard Response 15 Pin D-Connector PC Board Jumper location and Function .....	3-9
3-9 Current I/O Version PC Board Jumper Location and Function .....	3-10
3-10 Command Steps, Soft Start Disabled .....	3-11
3-11 100% Command Steps, Soft Start Enabled .....	3-11
3-12 Adjustment Potentiometer Location .....	3-14
3-13 Bench Troubleshooting Circuit .....	3-16
3-14 Response Adjustment .....	3-22
4-1 Model 5964/5850EM Orifice Sizing Nomograph .....	4-11
4-2 Example Nomograph .....	4-14

Tables

<u>Table Number</u>	<u>Page Number</u>
2-1 Recommended Filter Size .....	2-3
3-1 Cables, calibration Covers and PC Boards for Model 5964/5850EM .....	3-3
4-1 Bench Troubleshooting .....	4-4
4-2 Sensor Troubleshooting .....	4-5
4-3 Conversion Factors (Nitrogen Base) .....	4-7
4-4 Model 5964/5850EM Standard Restrictors .....	4-16

**1-1 How to Use This Manual**

This instruction manual is intended to provide the user with all the information necessary to install, operate and maintain the Brooks® Models 5964 and 5850EM

This manual is organized into the following sections:

Section 1.	Introduction
Section 2.	Installation
Section 3.	Operation
Section 4.	Maintenance
Section A	CE Certifications
Back Cover	Warranty, Local Sales/Service Contact Information

**1-2 Description**

The Brooks Models 5964 and 5850EM Mass Flow Controllers is used in gas flow handling systems where very low leakage and high performance are required. The Models 5964 and 5850EM incorporates metal seals or welded joints, insuring leak integrity for high purity and high vacuum applications. Reducing the amount of internal threads makes the design less prone to system contamination. The control electronics and flow sensor designs utilized in the Models 5964 and 5850EM have been well-proven in precision gas delivery systems. Standard features include:

- High leak integrity (less than  $10^{-10}$  atm-cc/sec He)
- Enhanced process (7 Ra) internal surface finish (Optional 5850EM)
- Electropolished wetted surfaces (Optional 5850EM)
- High purity VAR 316L Stainless Steel
- All metal seals
- Particulate free
- Wide flow range (0.06 sccm through 30,000 sccm)
- Insensitive to mounting attitude
- Negligible flow overshoot/undershoot
- Fast response control permits rapid gas settling times with minimal over/undershoot. Refer to Figure 1-1.
- Helium leak check ports
- Class 100 Clean Room assembly and calibration (Optional 5850EM)
- Available with all popular process connections

## Brooks® Models 5964, 5850EM

## 1-3 Specifications

**⚠ WARNING**

Do not operate this instrument in excess of the specifications listed in this manual. Failure to heed this warning can result in serious personal injury and/or damage to the equipment.

**PERFORMANCE CHARACTERISTICS:****Flow Ranges\***

Any range from 0 - 3 sccm to 0 - 30,000 sccm Nitrogen equivalent. Lower flows available, consult factory.

\*Standard: 0°C and 101 kPa (760 Torr). Per SEMI Guideline E12-96.

**Control Range**

2 - 100% with elastomeric valve seat

3 - 100% with metal or Teflon® valve seat

**Accuracy**

1% Full Scale including linearity, at calibration conditions

1.5% Full Scale including linearity, for flow ranges greater than 20 slpm

**Repeatability**

0.25% of rate

**Settling Time**

**Model 5964:** Enhanced response PCB's less than 1 sec to within 2% of Full Scale of final value for a 0-100% command step with Normally Closed Valve. (Optional on 5850EM).

**Model 5850EM:** Less than 3 seconds to within 2% of Full Scale of final value for a 0-100% command step with Normally Closed Valve.\*

\*Per SEMI Guideline E17-91.

**Mounting Attitude Sensitivity**

Available in any position

0.5% maximum full scale deviation after rezeroing

**Temperature Sensitivity**

Zero: Less than  $\pm 0.075\%$  full scale per °C

Span: Less than  $\pm 1.0\%$  full scale shift over 10-50°C range

**Pressure Equipment Directive (PED) 97/23/EC**

Sound Engineering Practice

**Pressure Sensitivity**

0.008% per psi Nitrogen

**RATINGS:****Operating Pressure**

1,500 psi (10.342 MPa) max.

**Note: 150 psi for enhanced response**

**500 psi for stainless steel fasteners option.**



**Differential Pressure**

Valve orifice sized for any pressure drop between 5 to 50 psi (Minimum pressure drop depends on gas and range).

**Ambient Temperature Limits**

Operating: 40°F to 150°F (5°C to 65°C)

Non-Operating: -13°F to 212°F (-25°C to 100°C)

**Leak Integrity**

Inboard to outboard  $1 \times 10^{-10}$  atm. cc/sec. Helium max.

**PHYSICAL CHARACTERISTICS:****Materials of Construction**

316L VAR (Vacuum Arc Remelt), 316L, and high alloy ferritic stainless steel.

External seals: Nickel.

Internal seals: Nickel.

Valve Seat: 316L, Viton® fluoroelastomers, Buna-N, Kalrez® or Teflon®.

**Dimensions**

Refer to Figures 1-1 thru 1-4

**Process Connections**

1/4" Tube VCR™

Downport C-Seal

Downport W-Seal

**Surface Finish**

5850EM: 32Ra, Passivated

5964: 7Ra, Electropolished

**ELECTRICAL CHARACTERISTICS:****Electrical Connections**

Card Edge: 30 microinch gold over low stress nickel-plated copper

D-Connector: 15 Pin (DA-15P)

**Command Input**

Voltage Option: 0-5 Vdc (Input resistance 40 k ohm min.)

Current Option: 4-20 mAdc (Input resistance 75 ohm)

**Output Signal**

Voltage Option: 0 to 5 Vdc into 2,000 ohms minimum

Current Option: Jumper selectable 4-20 mAdc or 0-20 mAdc, refer to Figure 2-6 for maximum total loop resistance

**ELECTRICAL CHARACTERISTICS (continued):**

**5 Volt Reference Output**

5 Volts,  $\pm 0.01$  Vdc into 2,000 ohms minimum

**Power Requirements**

Voltage Option:

N.C. Valve (or N.O. Valve with flow less than 2.5 slpm):

3.25 watts max., + 15 Vdc @ 35 mA -15 Vdc @ 180 mA

N.O. Valve with flow rate greater than 2.5 slpm:

10.5 watts max., +15 Vdc @ 350 mA, -15 Vdc @ 350 mA

Current Option:

+15 Vdc to +28 Vdc: 3.68 Watts min, +15 Vdc @ 245 mA

10.36 Watts max., +28 Vdc @ 370 mA

**Power Supply Sensitivity**

None within  $\pm 5\%$  of specified voltage (See Power Requirements)

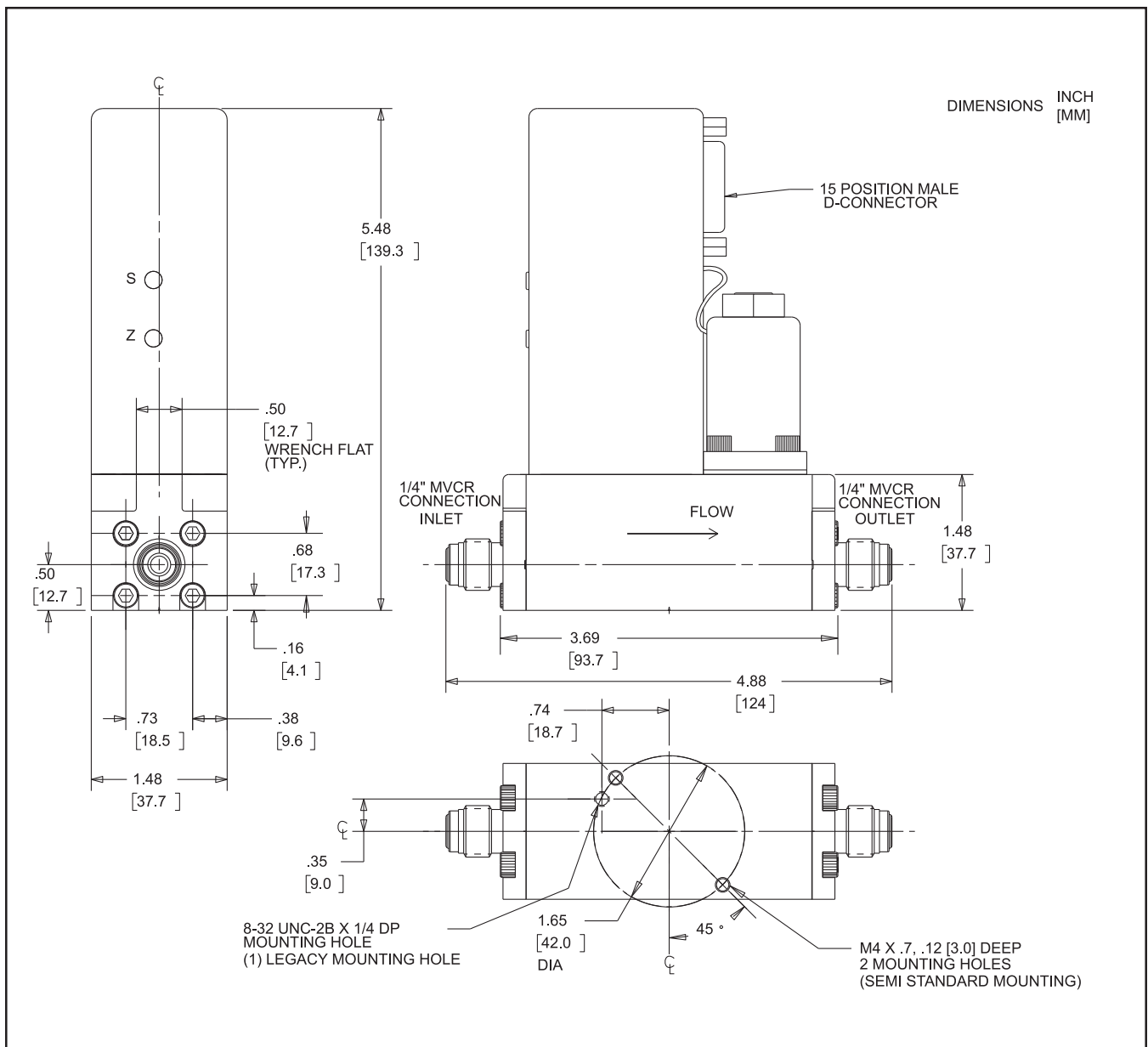

Figure 1-1 MFC/MFM Dimensional Drawing for Model 5964/5850EM with D-Connector and VCR Fittings

Brooks® Models 5964, 5850EM

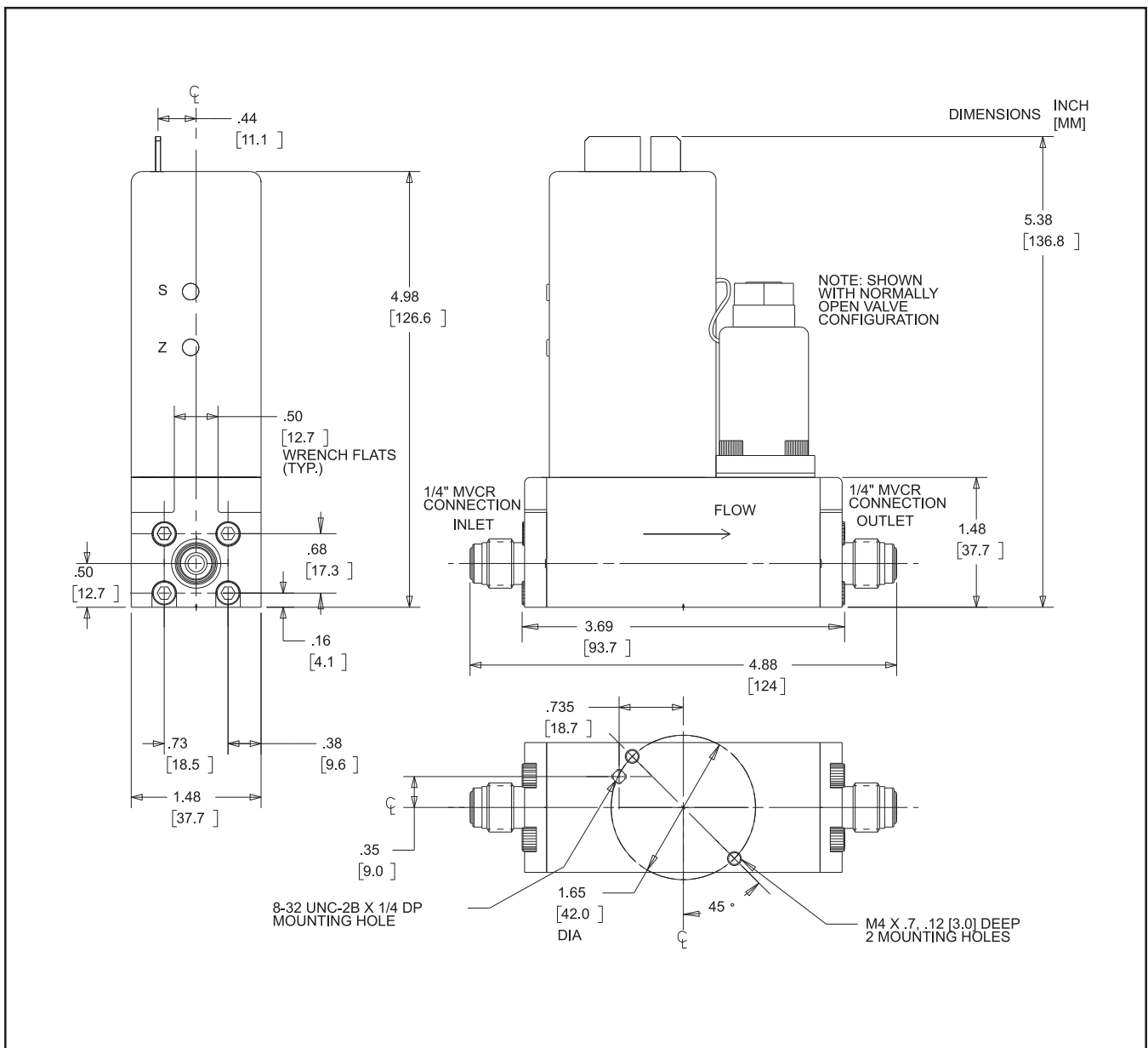

Figure 1-2 MFC/MFM Dimensional Drawing for Model 5964/5850EM with Card Edge and VCR Fittings

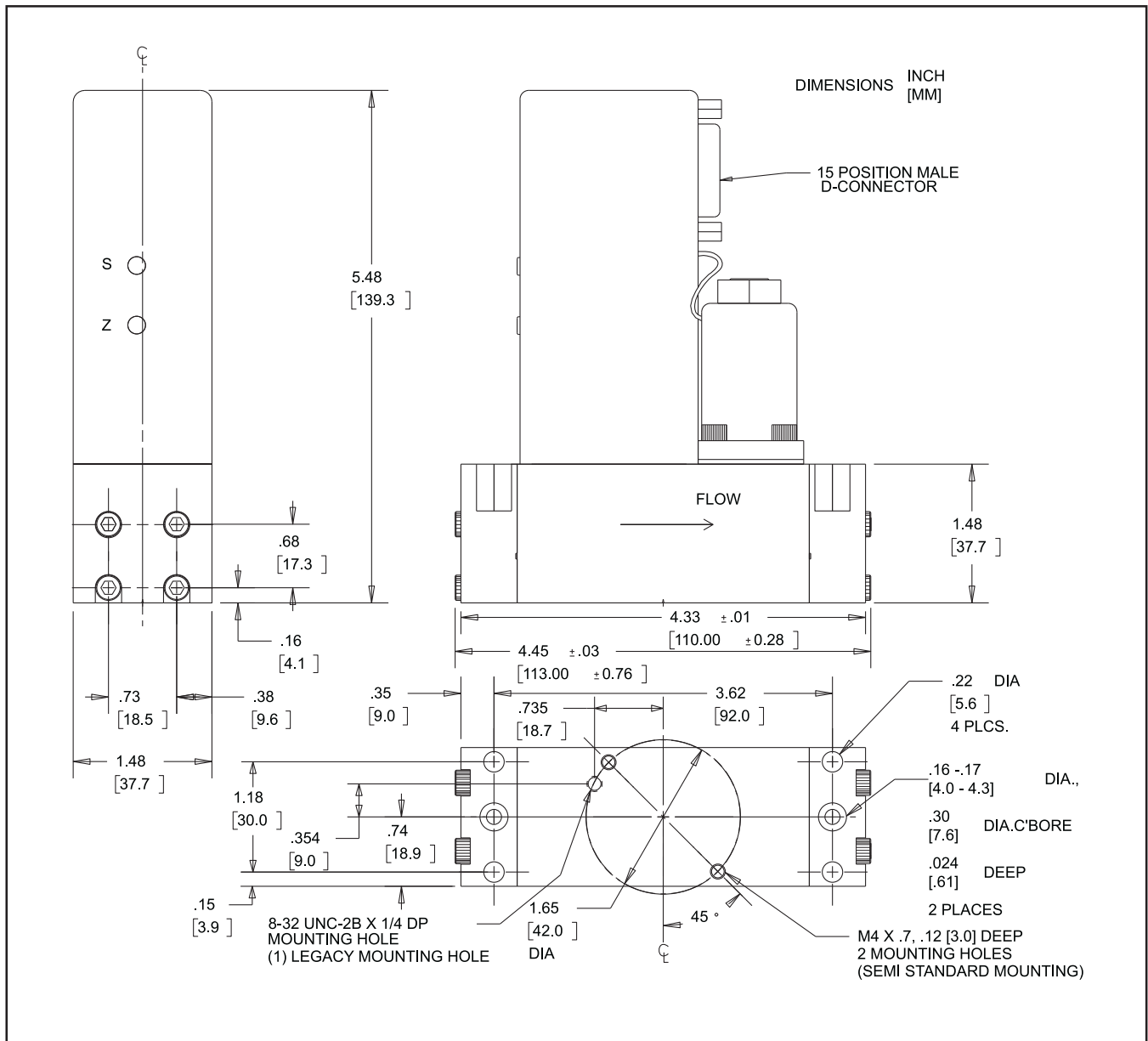

Figure 1-3 MFC/MFM Dimensional Drawing for Model 5964/5850EM Downported with D-Connector

Brooks® Models 5964, 5850EM

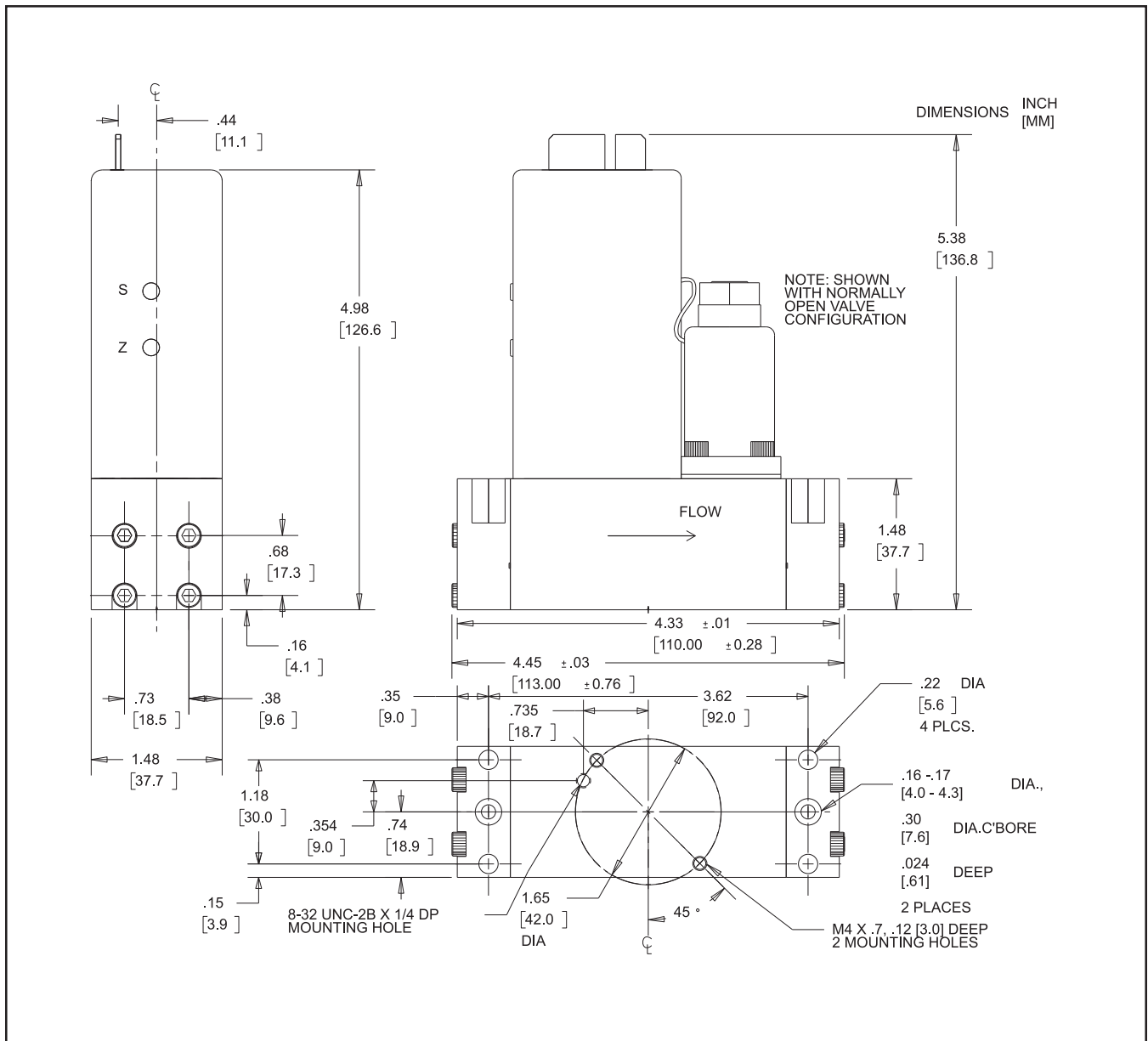

Figure 1-4 MFC/MFM Dimensional Drawing for Model 5964/5850EM Downported with Card Edge

**2-1 General**

This section contains the procedures for the receipt and installation of the instrument. See Section 1 for dimensional and connection requirements. Do not attempt to start the system until the instrument has been permanently installed. It is important that the start-up procedures be followed in the exact sequence presented.

**2-2 Receipt of Equipment**

When the instrument is received, the outside packing case should be checked for damage incurred during shipment. If the packing case is damaged, the local carrier should be notified at once regarding his liability. A report should be submitted to your nearest Product Service Department.

**Brooks Instrument**

407 W. Vine Street  
P.O. Box 903  
Hatfield, PA 19440 USA  
Toll Free (888) 554-FLOW (3569)  
Tel (215) 362-3700  
Fax (215) 362-3745  
E-mail: BrooksAm@BrooksInstrument.com  
www.BrooksInstrument.com

**Brooks Instrument**

Neonstraat 3  
6718 WX Ede, Netherlands  
P.O. Box 428  
6710 BK Ede, Netherlands  
Tel 31-318-549-300  
Fax 31-318-549-309  
E-mail: BrooksEu@BrooksInstrument.com

**Brooks Instrument**

1-4-4 Kitasuna Koto-Ku  
Tokyo, 136-0073 Japan  
Tel 011-81-3-5633-7100  
Fax 011-81-3-5633-7101  
Email: BrooksAs@BrooksInstrument.com

Remove the envelope containing the packing list. Carefully remove the instrument from the packing case. Make sure spare parts are not discarded with the packing materials. Inspect for damaged or missing parts.

**2-3 Recommended Storage Practice**

If intermediate or long-term storage of equipment is required, it is recommended that the equipment be stored in accordance with the following conditions:

- a. Within the original shipping container.
- b. Stored in a sheltered area, preferably a warm, dry, heated warehouse.
- c. Ambient temperature 21°C (70°F) nominal, 32°C (90°F) maximum, 45°F (7°C) minimum.
- d. Relative humidity 45% nominal, 60% maximum, 25% minimum.

## Brooks® Models 5964, 5850EM

**2-4 Return Shipment**

Prior to returning any instrument to the factory, contact your nearest Brooks location for a Return Materials Authorization Number (RMA#). This can be obtained from one of the following locations:

**Brooks Instrument**

407 W. Vine Street  
P.O. Box 903  
Hatfield, PA 19440 USA  
Toll Free (888) 554-FLOW (3569)  
Tel (215) 362-3700  
Fax (215) 362-3745  
E-mail: BrooksAm@BrooksInstrument.com  
www.BrooksInstrument.com

**Brooks Instrument**

Neonstraat 3  
6718 WX Ede, Netherlands  
P.O. Box 428  
6710 BK Ede, Netherlands  
Tel 31-318-549-300  
Fax 31-318-549-309  
E-mail: BrooksEu@BrooksInstrument.com

**Brooks Instrument**

1-4-4 Kitasuna Koto-Ku  
Tokyo, 136-0073 Japan  
Tel 011-81-3-5633-7100  
Fax 011-81-3-5633-7101  
Email: BrooksAs@BrooksInstrument.com

Instrument must have been purged in accordance with the following:

**⚠ WARNING**

**Before returning the device purge thoroughly with a dry inert gas such as Nitrogen before disconnecting gas connections. Failure to correctly purge the instrument could result in fire, explosion or death. Corrosion or contamination may occur upon exposure to air.**

All flow instruments returned to Brooks requires completion of Form RPR003-1, Brooks Instrument Decontamination Statement, along with a Material Safety Data Sheet (MSDS) for the fluid(s) used in the instrument. Failure to provide this information will delay processing by Brooks personnel. Copies of these forms can be downloaded from the Brooks website [www.BrooksInstrument.com](http://www.BrooksInstrument.com) or are available from any Brooks Instrument location listed above.

**2-5 Transit Precautions**

To safeguard the instrument against transportation damage, it is recommended to keep the instrument in its factory container until ready for installation.

**2-6 Removal from Storage**

Upon removal of the instrument from storage, a visual inspection should be conducted to verify its "as-received" condition. If the instrument has been subject to storage conditions in excess of those recommended (See Section 2-3), it should be subjected to a pneumatic pressure test in accordance with applicable vessel codes.



2-7 In-Line Filter

It is recommended that an in-line filter be installed upstream from the controller to prevent the possibility of any foreign material entering the flow sensor or control valve. The filtering element should be replaced periodically or ultrasonically cleaned.

Table 2-1 Recommended Filter Size

Maximum Flow Rate	Recommended Filter
100 sccm	1 micron
500 sccm	2 micron
1 to 5 slpm	7 micron
10 to 30 slpm	15 micron

2-8 Installation

Prior to installation, make certain all piping is clean and free of obstructions, for tubing installations. Install the piping in such a manner that permits easy access to the instrument if it needs to be removed for cleaning or test bench troubleshooting. For surface mount (downported) devices verify that the seal cavities are clean and free of lateral scratches.

**⚠ CAUTION**

**When installing the controller, care should be taken that no foreign materials enter the inlet or outlet of the instrument. Do not remove the protective end caps until time of installation.**

Recommended installation procedures:

- a. The Model 5964/5850EM should be located in a clean, dry atmosphere relatively free from shock and vibration.
- b. Leave sufficient room for access to the electrical components, span and zero potentiometers.
- c. Install in such a manner that permits easy removal if the instrument requires servicing.

**⚠ CAUTION**

**When used with a reactive (sometimes toxic gas) contamination or corrosion may occur as a result of plumbing leaks or improper purging. Plumbing should be checked carefully for leaks and the instrument purged with clean, dry N<sub>2</sub> before use.**

- d. The Model 5964/5850EM Mass Flow Controller can be installed in any position. However, mounting in orientations other than the original factory calibration (see calibration data sheet) can result in a 0.5% maximum full scale shift after re-zeroing.

**⚠ CAUTION**

Use caution when installing surface mount (downported) controllers. Most metal seals can not be reused after compression. Follow the seal manufacturers' recommendations for installation. Tighten the mounting screws in 10 in-lb. increments such that the seal undergoes uniform compression. Final torque values depend on the screw and hardware material and lubrication.

- e. The control valve in the Model 5964/5850EM provides precision control and is not designed for positive shut-off. If positive shut-off is required, it is recommended that a separate shut-off valve be installed in-line.

**⚠ CAUTION**

Since the Model 5964/5850EM Control Valve may not provide positive shut-off, a separate shut-off valve may be installed downstream for that purpose. It should be noted that a small amount of gas may be trapped between the downstream side of the mass flow controller and the shut-off valve which will result in a surge upon actuation of the shut-off valve. This surge can be reduced in magnitude by locating, close together, the controller and the shut-off valve or by moving the shut-off valve upstream of the controller.

**2-9 Electrical Interface****⚠ NOTICE**

The Brooks (electric/electronic) equipment bearing the CE mark has been successfully tested to the regulations of the Electro Magnetic Compatibility (EMC directive 89/336/EEC). Special attention is required when selecting the signal cable to be used with CE marked equipment.

Brooks supplies high quality cables which meet the specifications for CE certification. If you provide your own signal cable you should use a cable which is completely screened with a 100% shield. D-Connectors should also be shielded using a metal shield. If applicable, metal cable glands must be used to provide cable screen clamping. The cable screen should be connected to the metal shell or gland and shielded at both ends over 360 degrees. The shield should be terminated to an earth ground. See Appendix A for CE Certification of Mass Flow Equipment.

To insure proper operation, the Model 5964/5850EM must be connected per Figures 2-1 through 2-6 depending upon the type of printed circuit board and connector. As a minimum, the following connections must be made:

**Voltage I/O Version**

- Chassis Ground
- Signal Common
- Signal Output
- +15 Vdc Supply
- -15 Vdc Supply
- Command Input
- Command Common
- Supply Common
- Valve Return (Specific to applications see below)

**Current I/O Version**

- Chassis Ground
- Signal Output Return
- Voltage or Current Signal Output
- 15-28 Vdc Supply
- Supply Common
- Voltage or Current
- Voltage or Current Command Input
- Command Return

**⚠ NOTICE**

The Brooks (electric/electronic) equipment bearing the CE mark has been successfully tested to the regulations of the Electro Magnetic Compatibility (EMC directive 89/336/EEC). Special attention is required when selecting the signal cable to be used with CE marked equipment.

Brooks supplies high quality cables which meet the specifications for CE certification. If you provide your own signal cable you should use a cable which is completely screened with a 100% shield. D-Connectors should also be shielded using a metal shield. If applicable, metal cable glands must be used to provide cable screen clamping. The cable screen should be connected to the metal shell or gland and shielded at both ends over 360 degrees. The shield should be terminated to an earth ground. See Appendix A for CE Certification of Mass Flow Equipment.

Note: If older Brooks secondary electronics are used to power and control the Model 5964/5850EM, the 5 Volt reference must be enabled. Brooks secondary electronics that require the 5 Volt reference consist of 587x and 589x series.

**2-10 Operation Procedure**

- a. Mount the controller in its final orientation.
- b. Apply power to the controller and allow approximately 45 minutes for the instrument to warm up and stabilize its temperature.
- c. Turn on the gas supply.
- d. Command zero percent (0%) flow and observe the controller's output signal. If the output is not zero mVdc (10 mVdc), check for leaks and, if none are found, refer to the re-zeroing procedure in Section 3-6.
- e. Set the command for the desired flow rate to assume normal operation. Note: If a separate positive shut-off valve is not installed, a flow signal may result from leak-through. Leak-through is more significant with stainless steel and Teflon valve seats.

Brooks® Models 5964, 5850EM

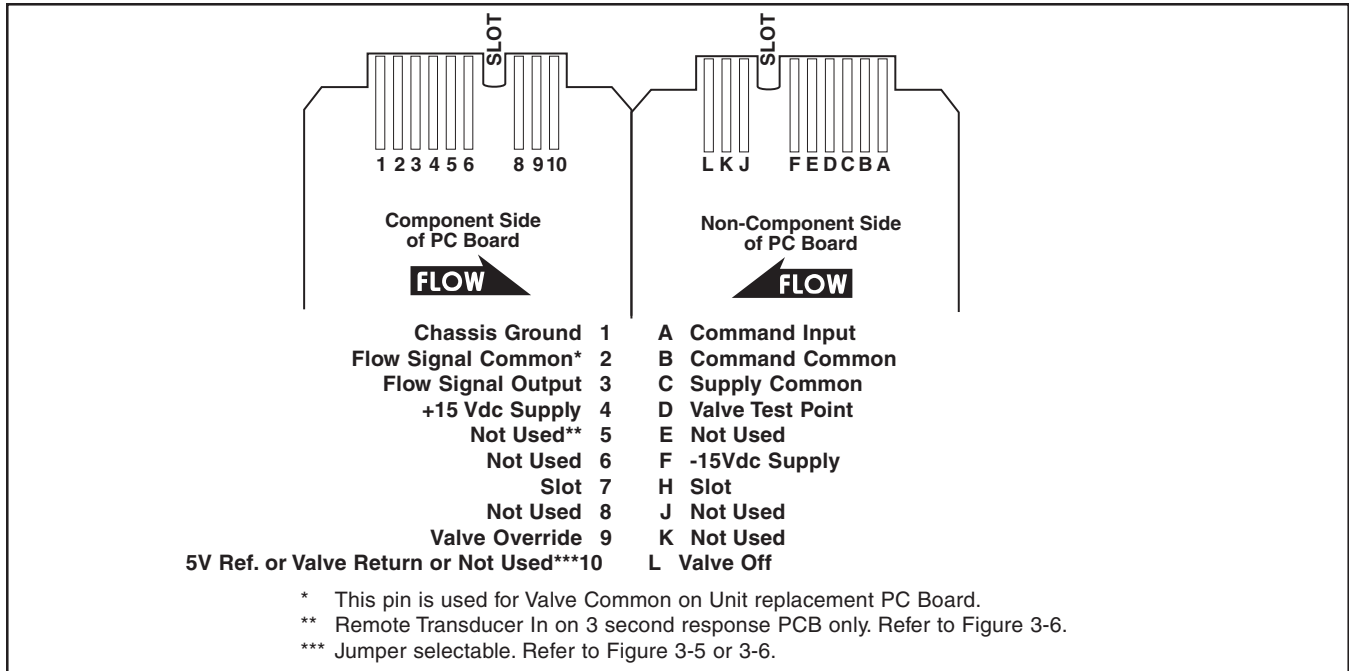

Figure 2-1 Card Edge Connector

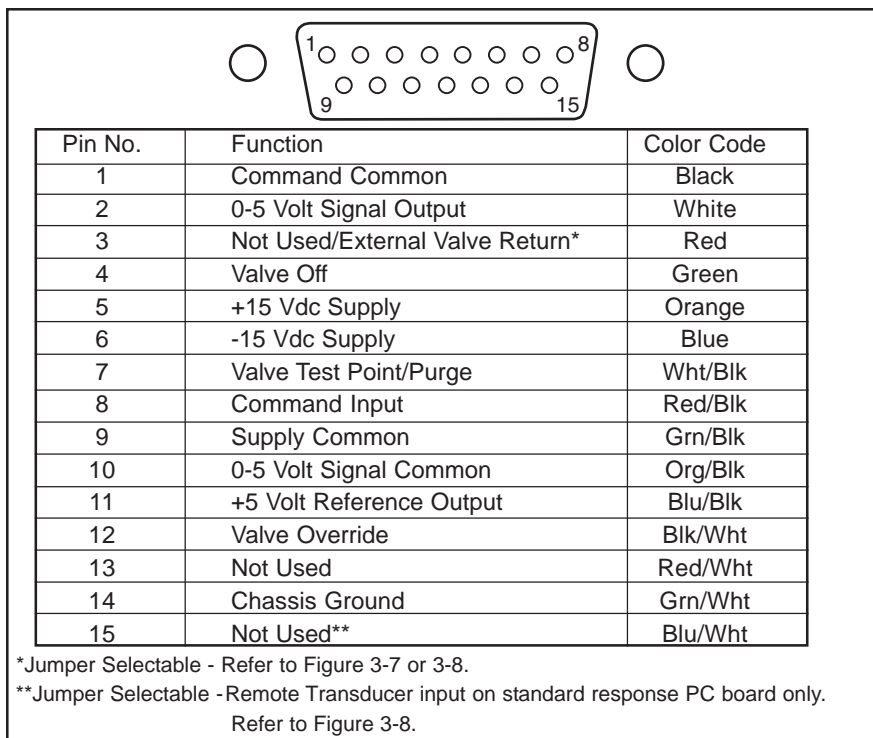

Figure 2-3 D-Connector Shielded Cable Hookup Diagram - Voltage I/O Versions

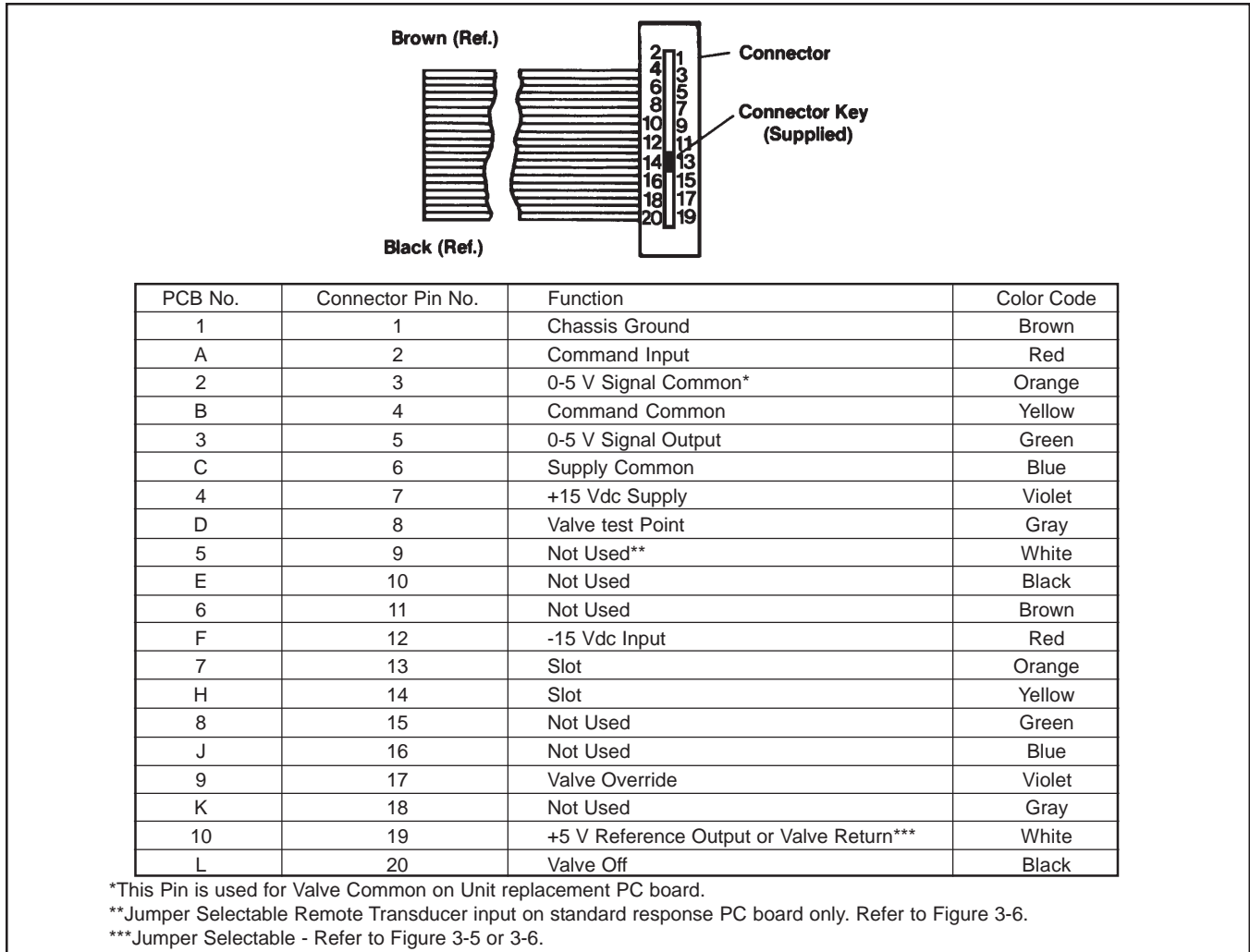

Figure 2-2 20 Pin Card Edge Connector Ribbon Cable Hookup Diagram

Brooks® Models 5964, 5850EM

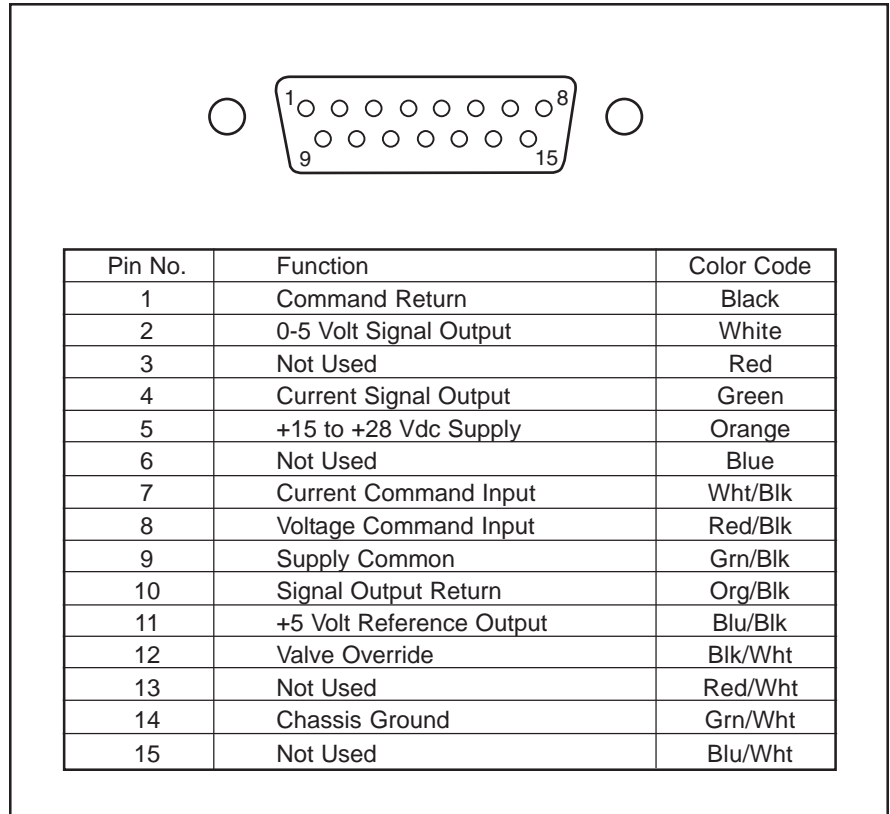

Figure 2-4 D-Connector Shielded Cable Hookup Diagram - Current I/O Version

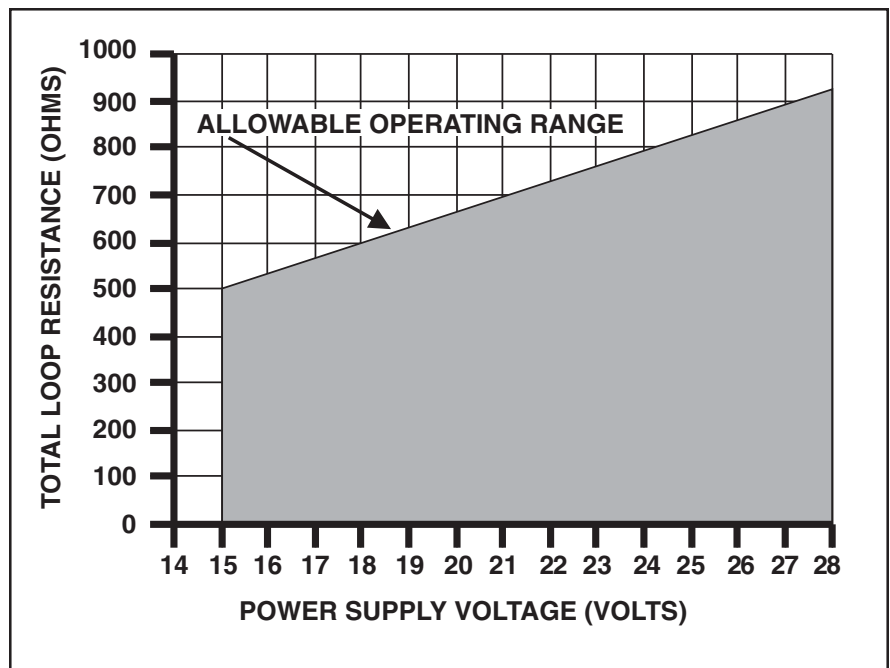

Figure 2-5 Maximum Allowable Loop Resistance - Current I/O Version

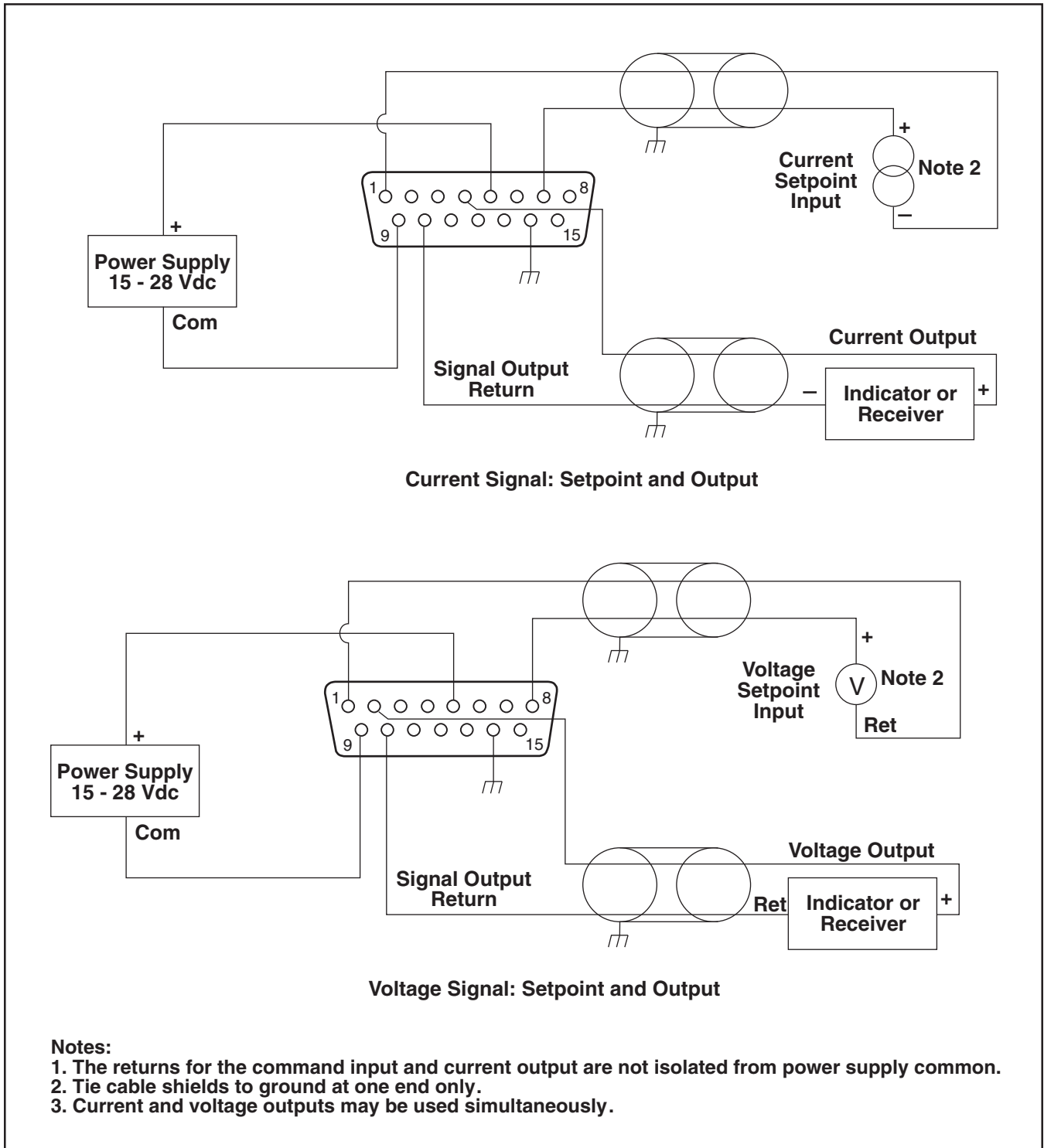

Figure 2-6 Common Electrical Hookups Current I/O Version

*THIS PAGE WAS  
INTENTIONALLY  
LEFT BLANK*



### 3-1 Overview

---

After the flowmeter has been properly installed in the process, it is ready for operation. When initiating flow, slowly open the valve to avoid a flow surge. Bypass is a help in bringing the flow on smoothly. Avoid starting a pump to supply the flowmeter without the use of a valve upstream of the flowmeter.

#### **⚠ WARNING**

**Before operating the flowmeter, ensure all fluid connections have been properly tightened and, where applicable, all electrical connections have been properly terminated.**

This section contains the following information:

- Features and Jumper Configurations
- Theory of Operation
- Adjustment Potentiometers
- Calibration and Response Adjustments

### 3-2 Connections and Controls

---

Figure 3-1 shows the locations of the Model 5964/5850EM controls and connections. Figure 3-2 identifies the externally accessible adjustment potentiometers located on the inlet side of the instrument.

Brooks® Models 5964, 5850EM

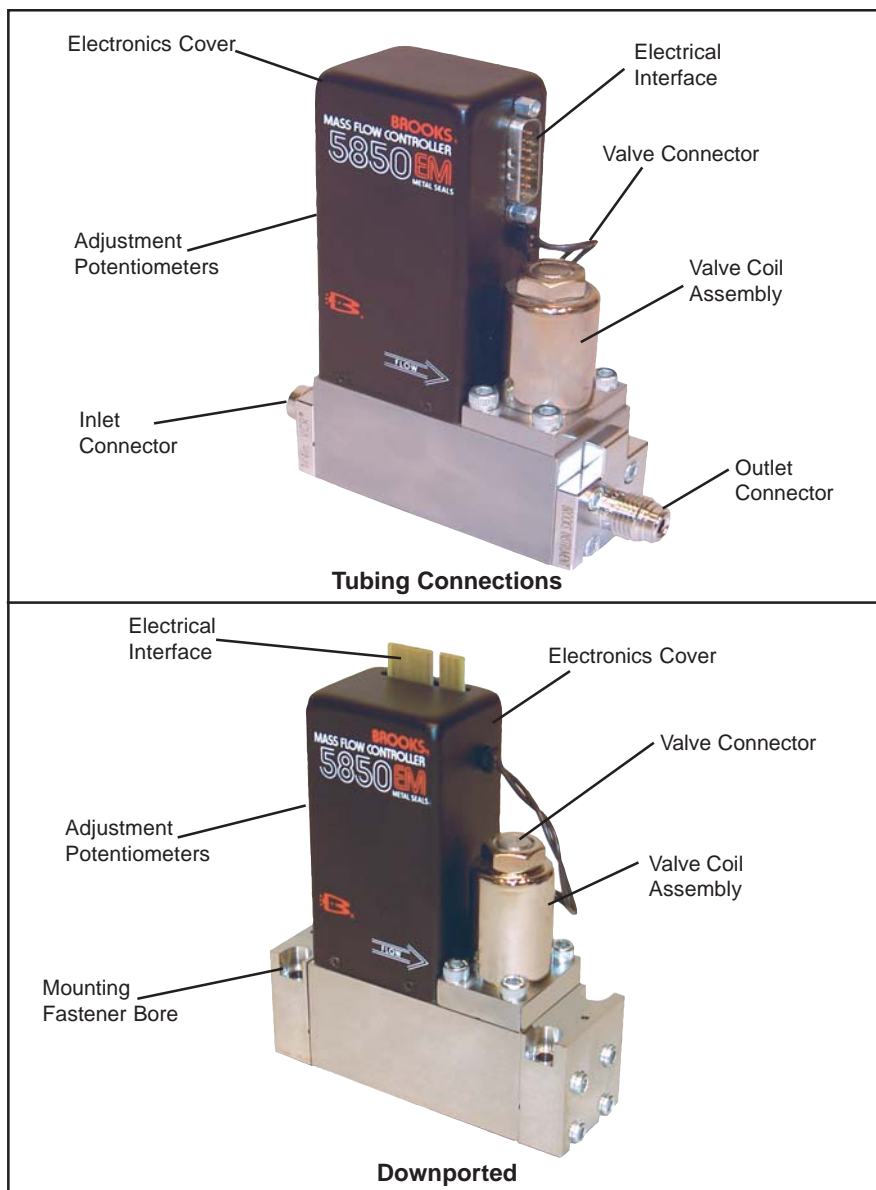

Figure 3-1 Model 5964/5850EM Components

*Table 3-1 Cables, Calibration Covers and PC Boards for Model 5964/5850EM*

<p><b>Break Out Board Assembly:</b>                  Card Edge P/N S273Z649AAA                  D-Connector P/N S273Z668AAA</p> <p>Installs directly between mass flow controller and interconnecting cable. Allows convenient access to all signals for easy troubleshooting of the system.</p> <p>Contains:                  1 Break Out PC Board                  1 5 foot Extension Cable                  1 Terminal PC Board</p>			<p><b>Calibration Cover:</b>                  Card Edge P/N 909Z011EAD                  D-Connector P/N 909Z017EAD</p> <p>Calibration covers reduce the chance of accidental contact with the circuit board but allow access for all adjustment potentiometers and test points needed for calibration.</p>			
5964/5850EM	To Model	Cable Type	Cable Part Number			
			5 feet	10 feet	25 feet	50 feet
Card Edge	0151E (Panel) Open Frame	Ribbon	S124Z469AAA	S124Z470AAA	S124Z471AAA	S124Z472AAA
	0151E (Table Top) 0152E 0154E	Shielded	S124Z669AAA	S124Z539AAA	S124Z562AAA	S124Z670AAA
D-Connector (Voltage I/O)	0151E (Panel) Open Frame	Shielded	S124Z361AAA	S124Z362AAA	S124Z363AAA	S124Z435AAA
	0151E (Table Top) 0152E 0154E	Shielded	S124Z576AAA	S124Z577AAA	S124Z578AAA	S124Z579AAA
D-Connector (Current I/O)	0151 <i>i</i> (Panel)	Shielded	S124Z361AAA	S124Z362AAA	S124Z363AAA	S124Z435AAA
	0151 <i>i</i> (Table Top) 0152 <i>i</i> 0154 <i>i</i>	Shielded	S124Z576AAA	S124Z577AAA	S124Z578AAA	S124Z579AAA

\*\*\*QTA = Viton, SUA = Buna, TTA = Kalrez

## Brooks® Models 5964, 5850EM

## 3-3 Theory of Operation

The thermal mass flow sensing technique used in the Model 5964/5850EM works as follows:

A precision power supply provides a constant power heat input (P) at the heater which is located at the midpoint of the sensor tube. Refer to Figure 3-3. At zero, or no flow conditions, the heat reaching each temperature sensor is equal. The temperatures T1 and T2, therefore, are equal. When gas flows through the sensor tube, the upstream sensor is cooled and the downstream sensor is heated which produces a temperature difference. The temperature difference T2-T1 is directly proportional to the gas mass flow. The equation is:

$$\Delta T = A * P * Cp * m$$

Where:

$\Delta T$	=	Temperature difference T2 - T1 (K)
Cp	=	Specific heat of the gas at constant pressure (kJ/kg-K)
P	=	Heater power (kJ/s)
m	=	Mass flow (kg/s)
A	=	Constant of proportionality (s <sup>2</sup> -K <sup>2</sup> /kJ <sup>2</sup> )

A bridge circuit interprets the temperature difference and a differential amplifier generates a linear 0-5 Vdc signal directly proportional to the gas mass flow rate.

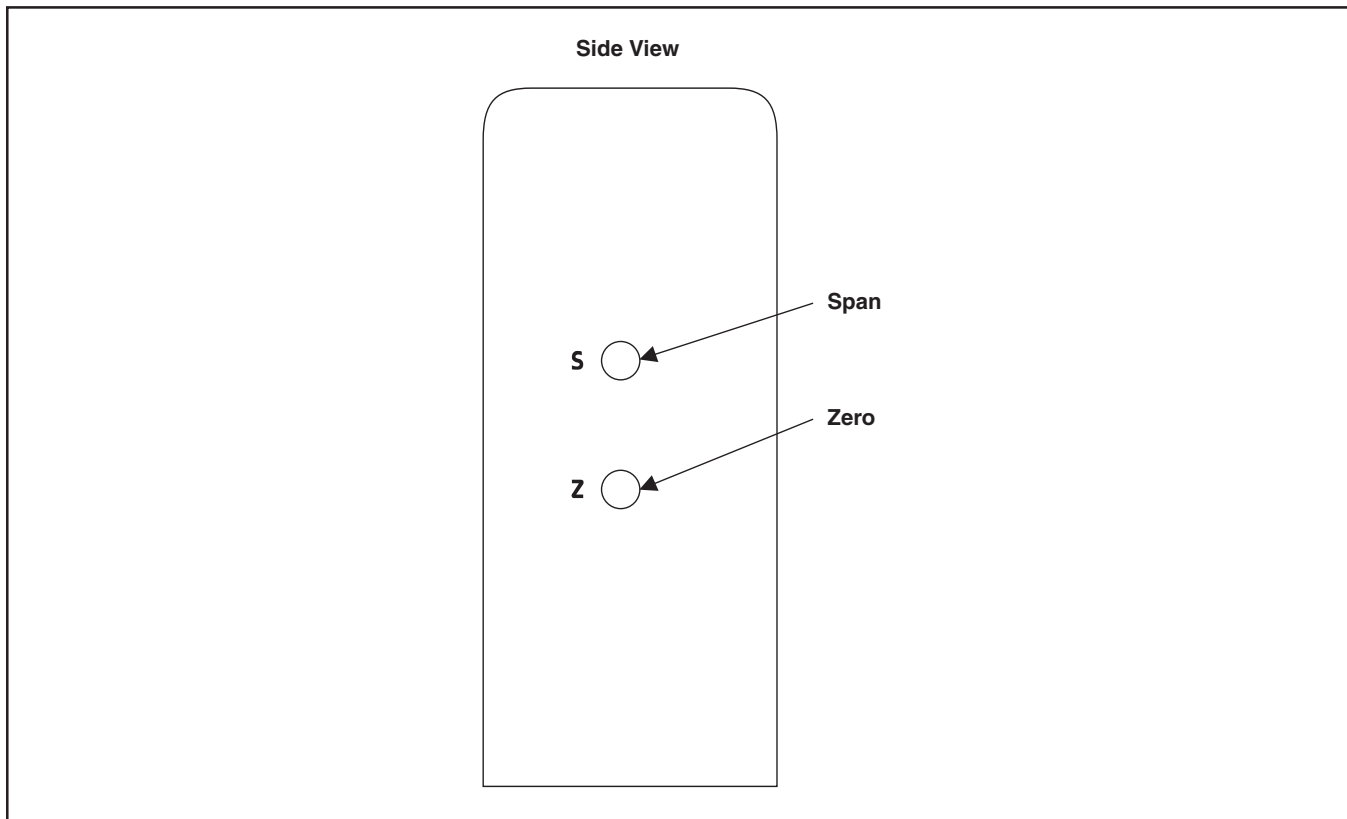

Figure 3-2 Externally Accessible Adjustments

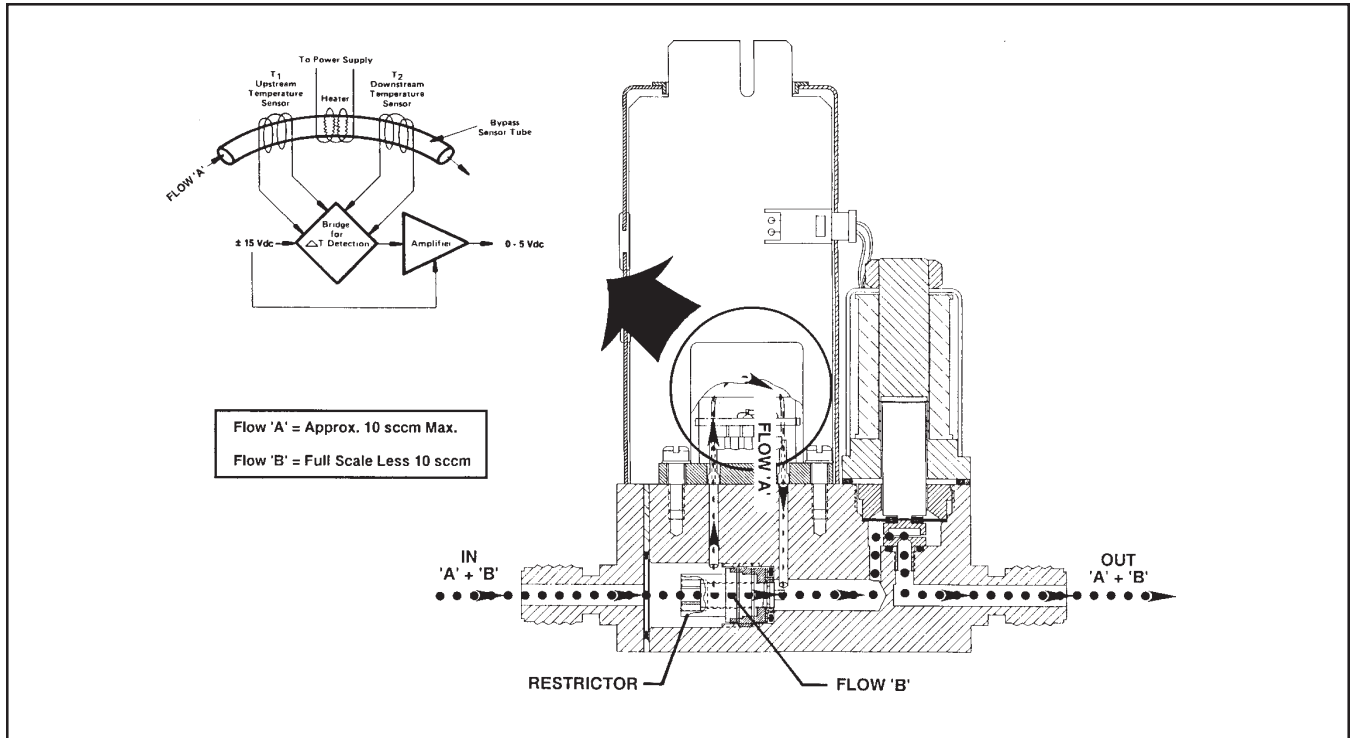

Figure 3-3. Flow Sensor Operational Diagram (VCR™ End Connections Shown)

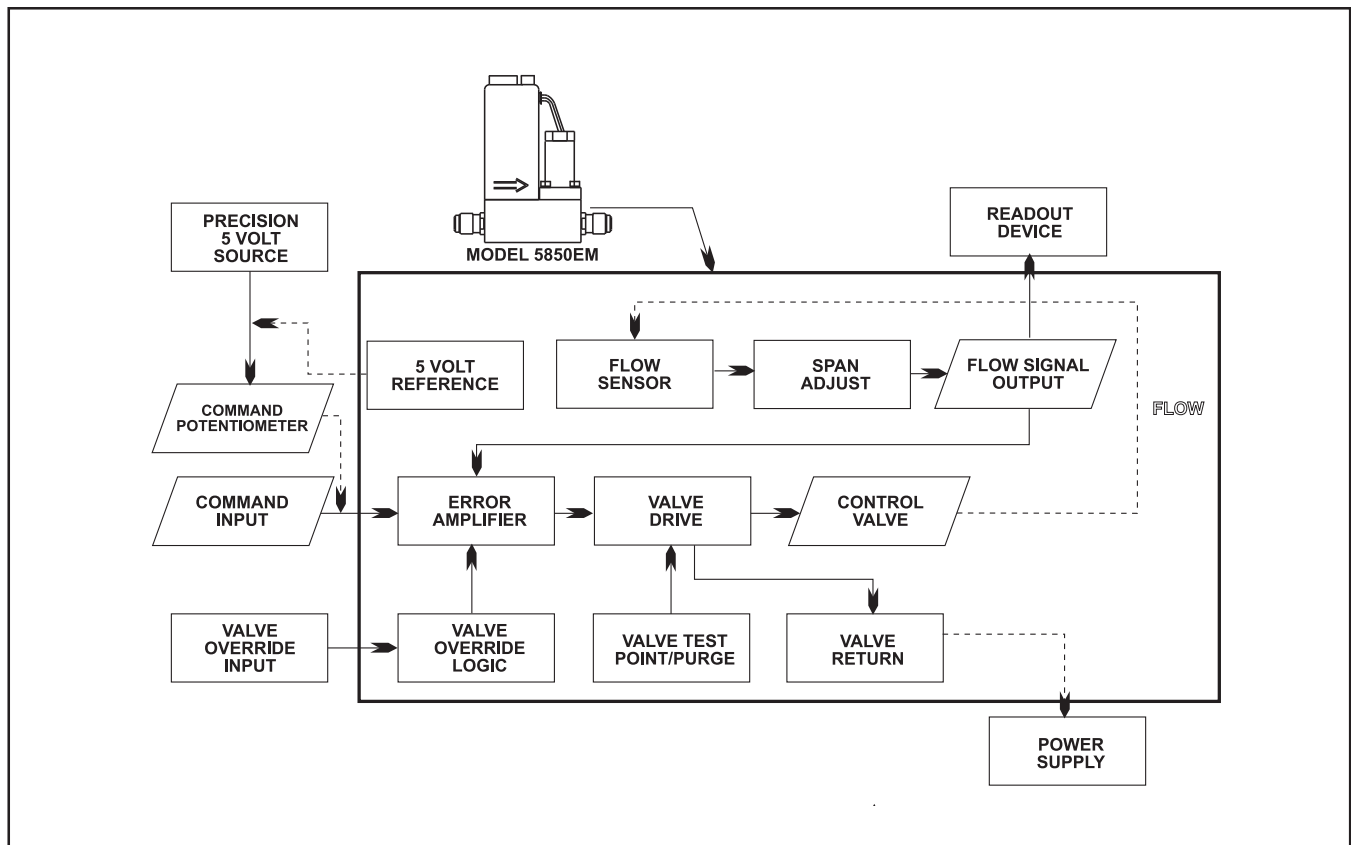

Figure 3-4. Flow Control System Block Diagram.

---

Brooks® Models 5964, 5850EM

---

The flow restrictor shown in Figure 3-3 performs a ranging function similar to a shunt resistor in an electrical ammeter. The restrictor provides a pressure drop that is linear with flow rate. The sensor tube has the same linear pressure drop/flow relationship. The ratio of the restrictor flow to the sensor tube flow remains constant over the range of the meter. Different restrictors have different pressure drops and produce meters with different full scale flow rates. The span adjustment, in the electronics, affects the fine adjustment of the meter's full scale flow.

In addition to the mass flow sensor, the Model 5964/5850EM Mass Flow Controller has an integral control valve and control circuit as shown in Figure 3-4. The control circuit senses any difference between the flow sensor signal and the command input, adjusting the current in the modulating solenoid valve to increase or decrease the flow.

### 3-4 Features

---

Note: All Model 5964/5850EM mass flow controllers/meters are configured at the factory as ordered and do not require adjustment. The following section is for reference should installation conditions change. Not all features are available on all devices.

Refer to Figures 3-5 through 3-9 depending upon the type of printed circuit board and connector for jumper locations, functions and adjustment potentiometers.

Note: To obtain access to the jumpers and test points referenced in this section, the Electronics Cover must be removed. Extract the cover by removing the three screws and the valve connector. The cover must be replaced before returning the device to service.

#### **Fast Response**

Adjusted by the anticipate potentiometer, and where applicable the response potentiometer, this circuit, when properly adjusted, allows the high frequency information contained in the sensor signal to be amplified. This provides a faster responding flow signal for remote indication and use by the control valve.

#### **Soft Start** (Refer to Figures 3-10 and 3-11)

This circuit provides a slow injection of the gas as a protection to the process, particularly those using a volatile or reactive gas. Full gas flow is achieved in approximately 15 seconds. This is enabled by moving the J2-Red Jumper on the printed circuit board. Refer to Figures 3-5 through 3-9, as applicable for jumper configurations.

#### **Valve Test Point/Purge**

This feature allows the user to monitor a relative control valve voltage during operation. One terminal of the valve coil is connected to the -15 Vdc supply, the other terminal is modulated by the electronics. The relative valve voltage can be measured between circuit common and Pin D of the card edge version or Pin 7 of the D-Connector version.

Grounding the valve test point pin will cause the valve to open fully on normally closed devices and close fully on normally open devices regardless of command input voltage.

Note: The Current I/O Version does not offer purge functions or a relative control valve voltage monitor.

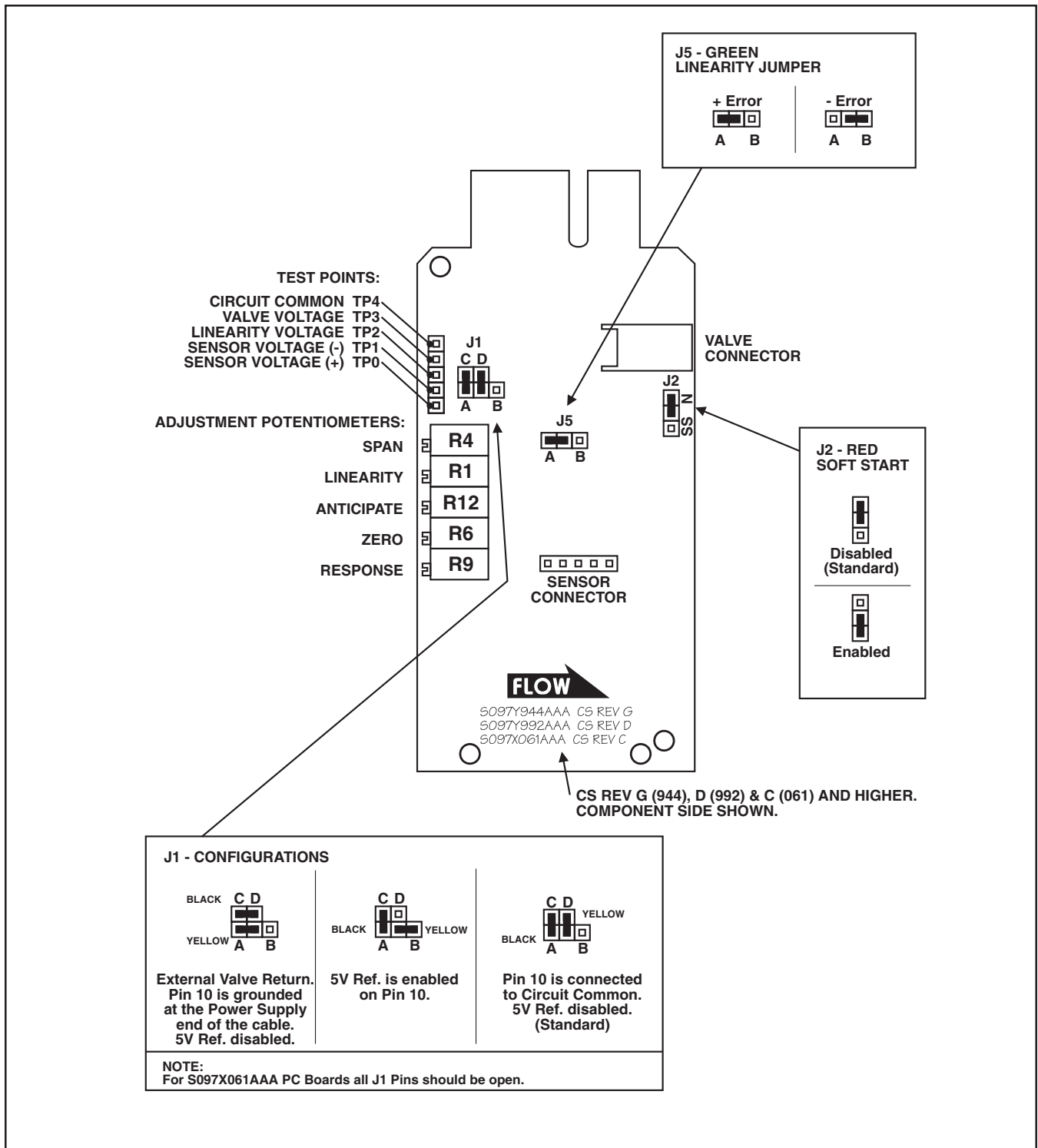

Figure 3-5 Enhanced Response 20 Pin Card Edge PC Board Jumper Location and Function

Brooks® Models 5964, 5850EM

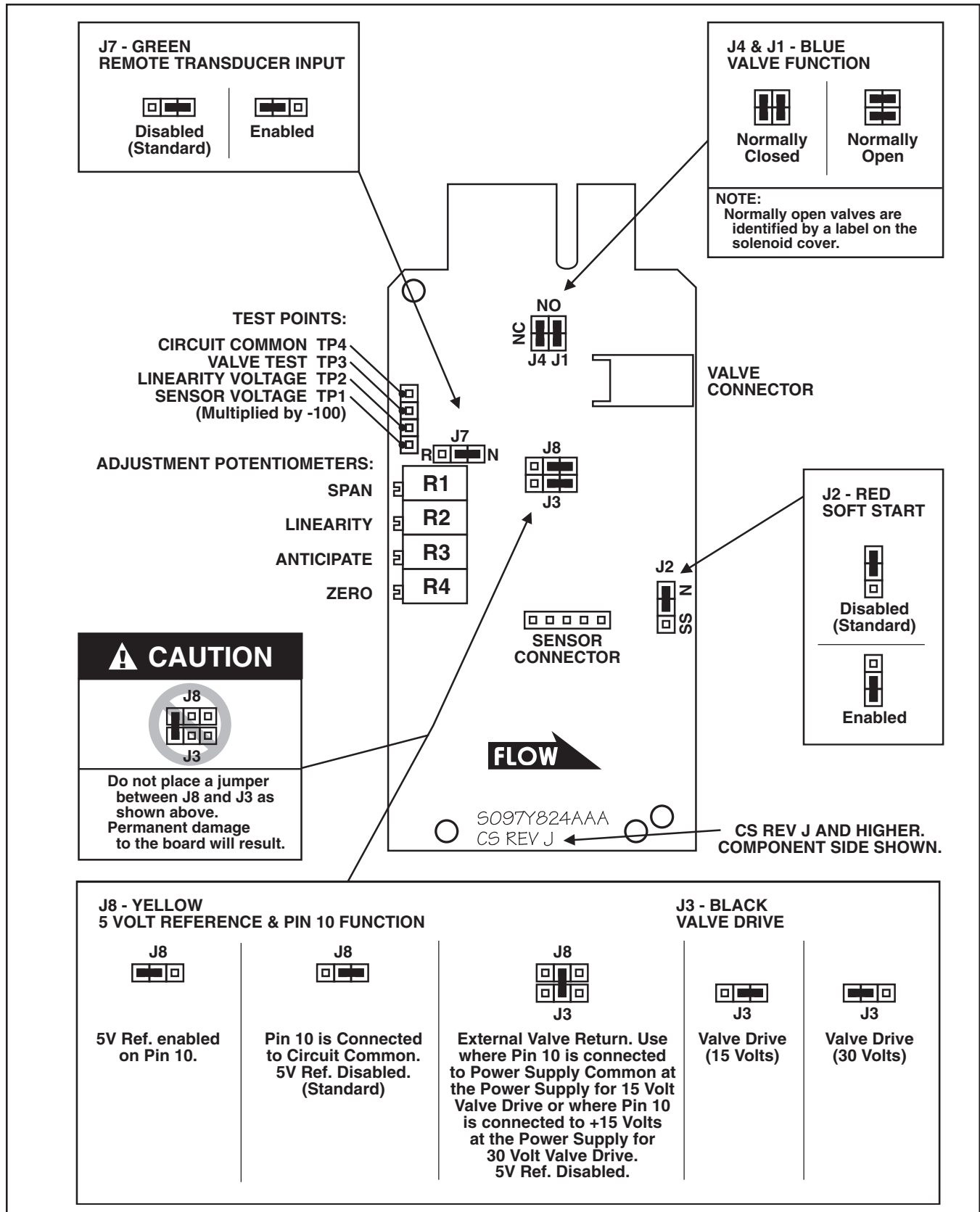

Figure 3-6 Standard Response 20 Pin Card Edge PC Board Jumper Location and Function



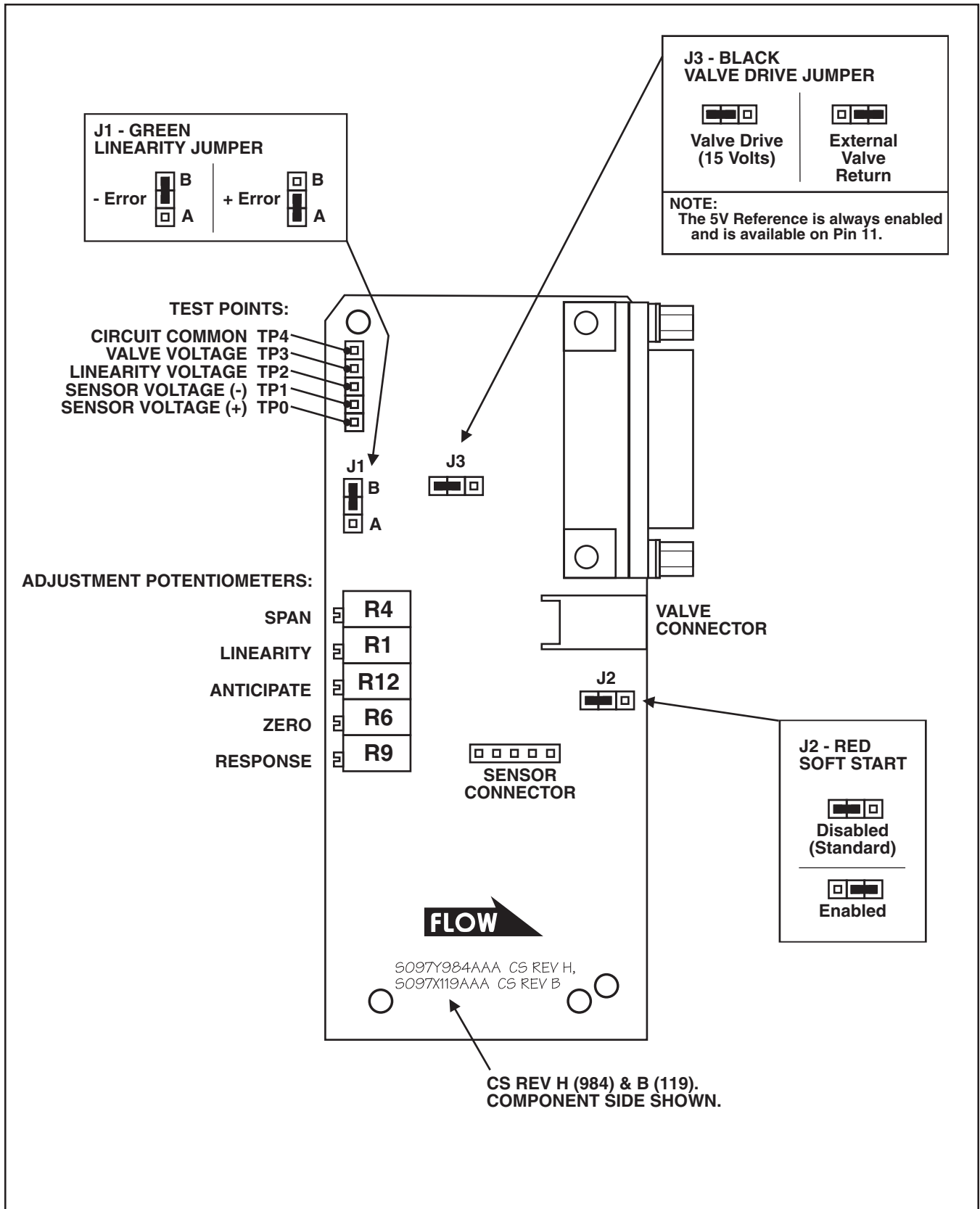

Figure 3-7 Enhanced Response 15 Pin D-Connector PC Board Jumper Location and Function

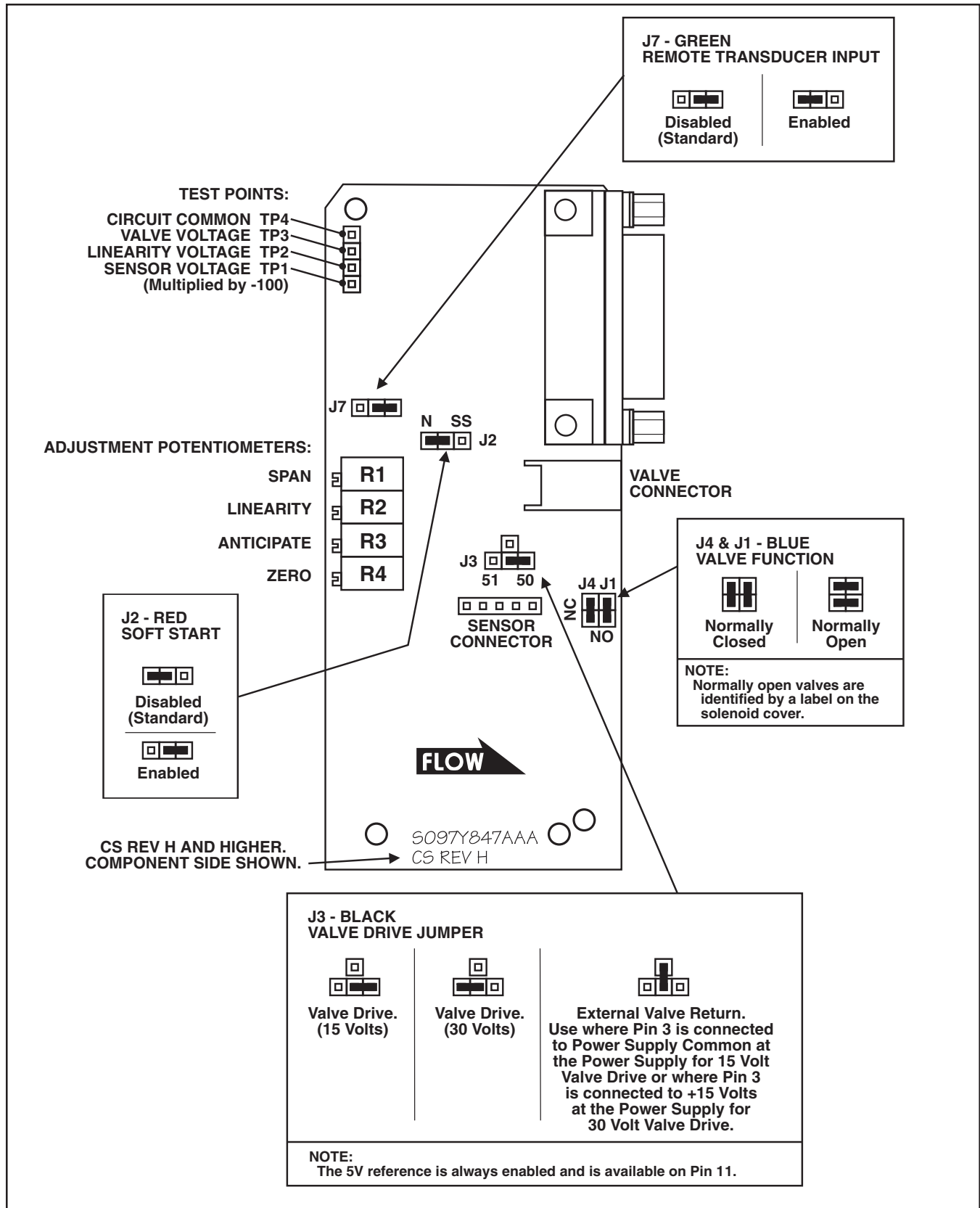

Figure 3-8 Standard Response 15 Pin D-Connector PC Board Jumper Location and Function

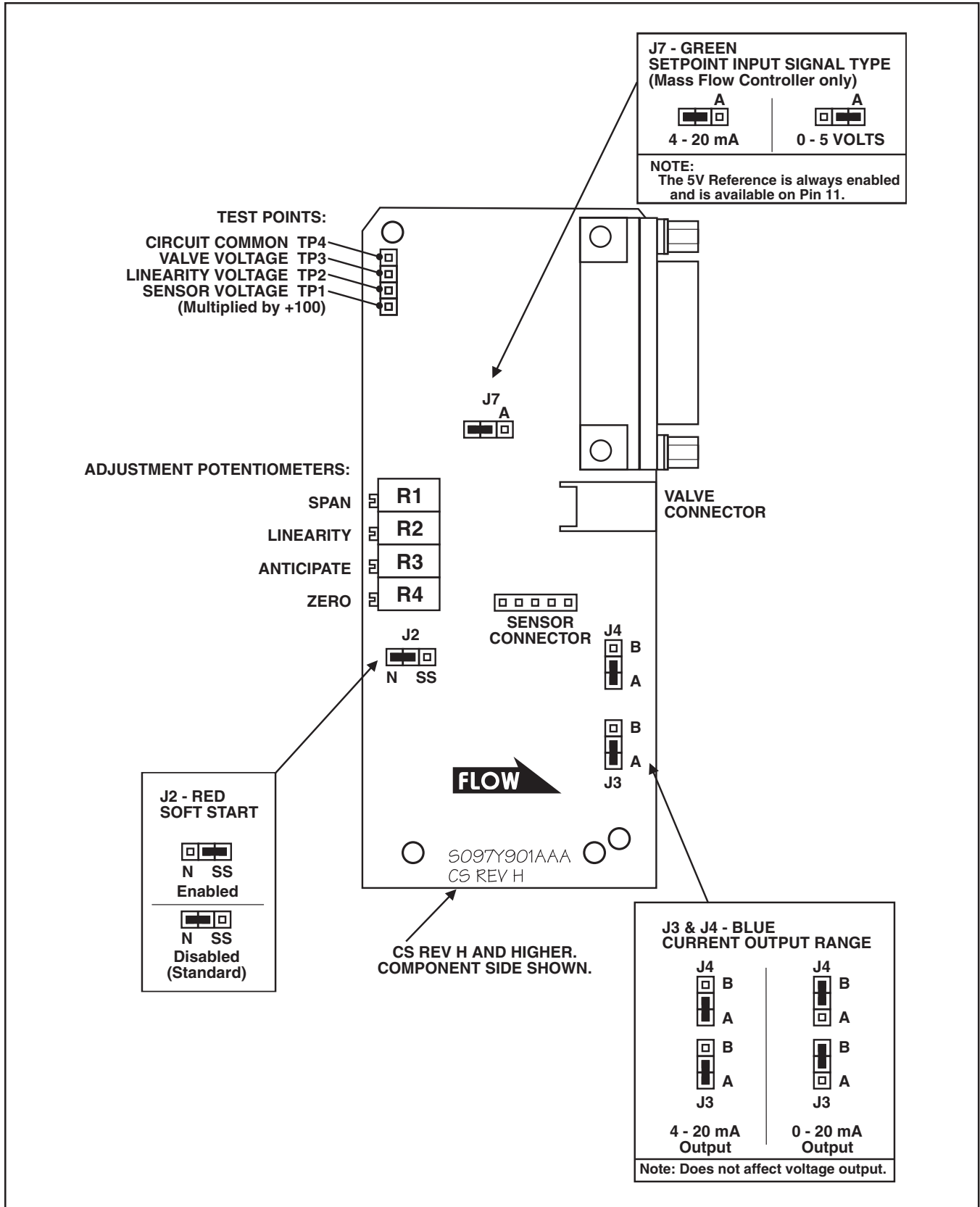

Figure 3-9 Current I/O Version PC Board Jumper Location and Function

Brooks® Models 5964, 5850EM

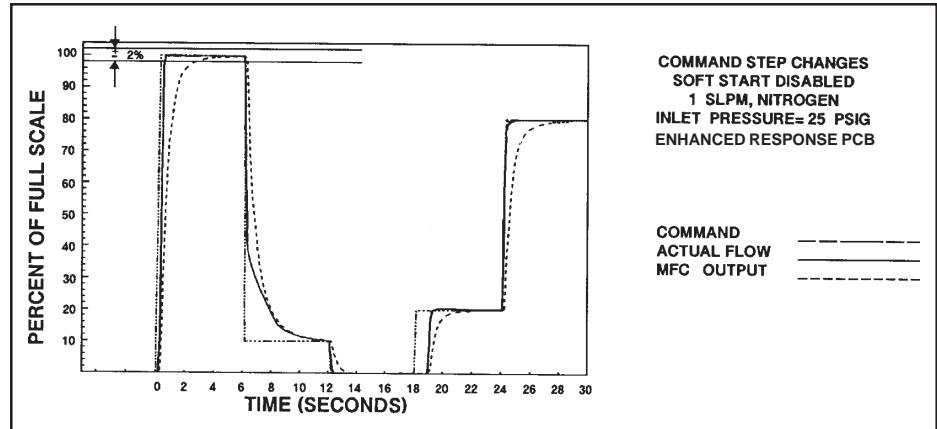

Figure 3-10 Command Steps, Soft Start Disabled

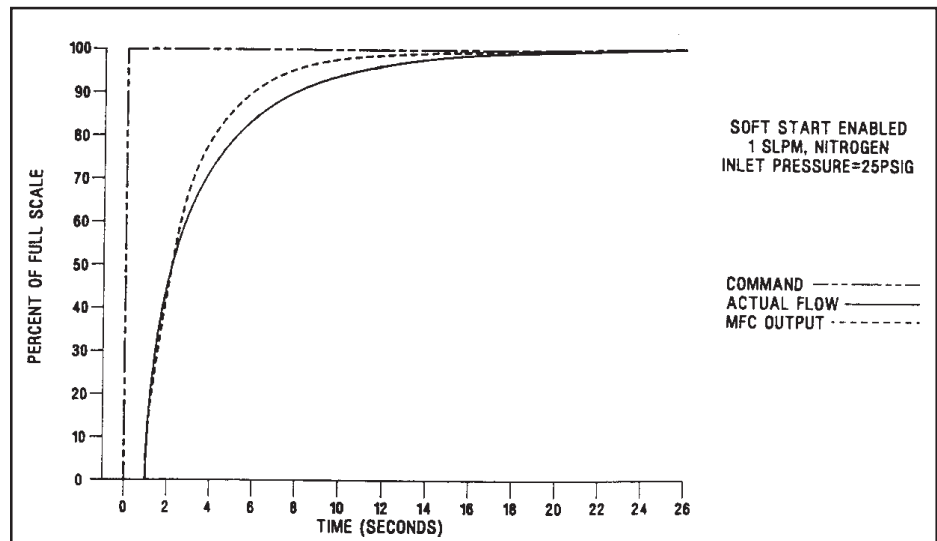

Figure 3-11 100% Command Step, Soft Start Enabled

**Five-Volt Reference Output/Valve Drive Configuration**

The 5 Volt reference output is required if a potentiometer is to be used to generate the Command Signal. On Card Edge PC Boards, Pin 10 can be jumper selected as any of three mutually exclusive functions, 5 Volt reference output, external valve return or "not used." In the "not used" state Pin 10 is connected to Circuit Common.

**⚠ CAUTION**

**Do not ground the 5 Volt reference output when it is enabled. Improper operation of the printed circuit board will result.**

The external valve return is used to minimize the effect of resistance in the connection wiring. If the "external valve return" feature is not enabled, the valve voltage is returned internally on the printed circuit board and the connection wiring resistance must be less than 0.2 ohms.

- a. Card Edge Connector Version  
On the enhanced response PC Board, Pin 10 is configured using the J1 black and yellow jumpers. On the standard response PC Boards Pin 10 is configured using the J3 black and J8 yellow jumpers. Refer to Figure 3-5 or 3-6 as applicable for jumper configurations.
- b. D-Connector - Voltage I/O Version Only  
The valve drive is configured using the J3 black jumper. The 5 Volt reference is always available on Pin 11. Refer to Figures 3-7 and 3-8 as applicable for jumper configurations.
- c. D-Connector - Current I/O Version  
The current I/O PC Board provides a 5 Volt reference on Pin 11 at all times. The external valve return is not available with this version. Valve voltage is always returned internally on the printed circuit board. Refer to Figures 2-4 and 3-9.

**Valve Override**

Allows full opening and closing of the control valve, independent of the command input. The valve override for normally closed and normally open mass flow controllers is as follows:

- a. To open the valve, apply +15 Vdc supply voltage to the valve override pin.
- b. To close the valve, apply -15 Vdc supply voltage to the valve override pin.
- c. Isolating the valve override pin returns the controller to normal operation. The valve override function is activated by applying the appropriate voltage to Pin 9 for Card Edge versions or Pin 12 for D-Connector versions.

---

**Brooks® Models 5964, 5850EM**

---

**Valve Off**

This feature allows the user to close the control valve by supplying a TTL level low signal (<0.4 Vdc) to the proper terminal, independently of the command input. A TTL level high or floating at this pin has no effect. Valve off is accessed via Pin L on the Card Edge or Pin 4 on the D-Connector version.

Note: Valve off is not available on Current I/O versions.

**Remote Transducer Input**

This feature allows the use of the integral control electronics and valve to regulate flow in response to signal from an external 0-5 Vdc signal. The flow signal from the Model 5964/5850EM is still available for process monitoring. This feature is only available on standard response versions. The external signal is applied to Pin 5 on the Card Edge version or Pin 15 D-Connector. The input signal is selected by the J7 green jumper. Refer to Figure 3-6 or 3-8 as applicable for jumper configurations.

**Low Command Flow Cutoff (Auto Shut-Off)**

Prevents the valve from opening whenever the command input is less than 2% of full scale. This function is always active and is present on all versions.

**Output Limiting**

Prevents possible damage to delicate data acquisition devices by limiting the output to +6.8 Vdc and -7 Vdc (0 to 26 mA with the Current I/O Option).

**Current I/O Version** (Refer to Figures 2-4, 2-5, 2-6 and 3-9)

## a. Input Signal Selection

To use the current command, connect the command signal (+) to Pin 7 of the D-Connector and the command return (-) to Pin 1 of the D-Connector. Configure the J7 green jumper in the left position.

To use the voltage command, connect the command signal (+) to Pin 8 and the command return (-) to Pin 1 of the D-Connector. Configure the J7 green jumper in the right position.

## b. Output Signal Selection

To use the current output, connect the output (+) signal to Pin 4 of the D-Connector and the output return (-) to Pin 10. The current output range is jumper selectable from 4-20 mA or 0-20 mA using the J3 and J4 blue jumpers. The 0-5 Vdc output signal is always enabled on Pin 2.

3-5 Adjustment Potentiometers

All Model 5964/5850EM instruments are factory calibrated for optimum performance. The only potentiometer recommended for field adjustment is the Zero. As shown in Figure 3-2, access to the Zero Potentiometer is provided by removing the plug labeled 'Z'. The Span Adjustment is also accessible by removing the 'S' plug, however, its adjustment is not recommended as described below. Adjustment of the remaining potentiometers necessitates removal of the electronics cover.

**⚠ CAUTION**

**Adjusting potentiometers can seriously affect the performance of the mass flow controller and should only be performed by properly trained and qualified personnel.**

**Span**

The span potentiometer is used to adjust the full scale setting of the mass flow controller. An adjustment in the clockwise direction will give less flow while turning counterclockwise will give more flow. Adjusting this potentiometer will alter the calibration and is therefore not recommended unless calibrating the device.

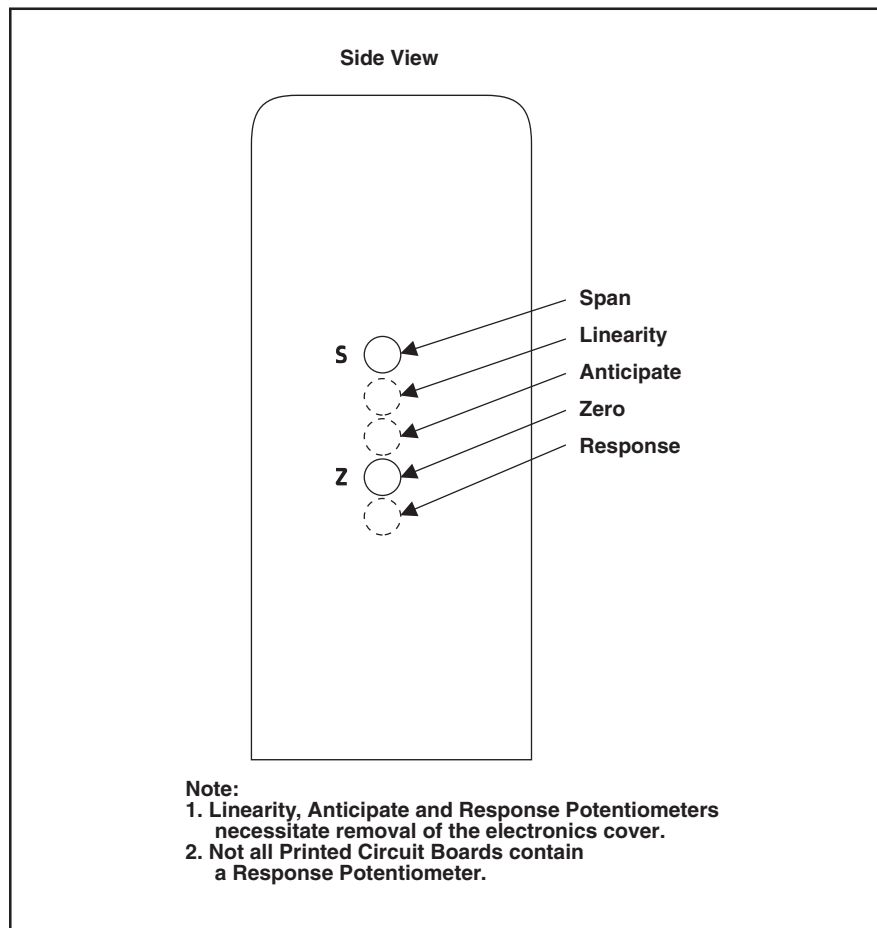

Figure 3-12 Adjustment Potentiometer Location

---

Brooks® Models 5964, 5850EM

---

**Linearity**

The linearity potentiometer is used to linearize the flow calibration due to subtle non-linearities in various bypass elements. The linearity signal can be viewed between TP2 and TP4 (circuit common). The value of the signal is flow rate and gas dependent. On enhanced response PC boards adjusting the potentiometer clockwise will increase the absolute value of this number. On standard response and Current I/O PC boards adjusting the potentiometer clockwise will increase this number. Adjusting this potentiometer will alter the calibration and is therefore not recommended unless calibrating the device.

**Anticipate**

The anticipate potentiometer is used to adjust the response of the sensor for steps in flow. Adjusting this potentiometer in the clockwise direction will slow the response of flow signal and cause a **controller** to overshoot more. Adjusting this potentiometer will alter the response of the mass flow controller and is therefore not recommended unless adjusting the response of the device.

**Zero**

The zero potentiometer is used to balance the thermal sensor at a no flow condition. This potentiometer is adjusted at the time of calibration and minor adjustments may be done in the field. See the "Zero Adjustment" section below for details.

**Response**

The response potentiometer is used to adjust the response of the sensor for steps in flow. Adjusting this potentiometer in the clockwise direction will increase actual flow overshoot. Adjusting this potentiometer will alter the response of the mass flow controller and is therefore not recommended unless adjusting the response of the device.

Note: Only enhanced response printed circuit boards are equipped with a response potentiometer.

**3-6 Zero Adjustment**

---

Each Model 5964/5850EM is factory adjusted to provide a zero  $\pm 10$  mVdc at zero flow. The adjustment is made in our calibration laboratory which is temperature controlled to 20°C (68°F  $\pm 3$ °F). After initial installation and warm-up in the gas system, the zero flow indication may be other than the factory setting. This is primarily caused by changes in temperature between our calibration laboratory and the final installation. The zero flow reading can also be affected, to a small degree, by changes in line pressure and mounting attitude.

To check zero, always mount the controller in its final configuration and allow a minimum of twenty minutes for the temperature of the controller and its environment to stabilize. If an upstream shut-off valve is installed it should be closed. Verify that the gas system is not pressurized. Using a suitable voltmeter, check the controller output signal. If it differs from the factory setting, adjust it by removing the lower pot hole plug (refer to Figure 3-2) which is located closest to the controller body. Adjust the zero potentiometer until the desired output signal is obtained.



**3-7 Calibration Procedure**

If the valve has been disassembled and any of the following parts have been replaced, the control valve adjusting procedure in Section 4-4 must be performed before the Model 5964/5850EM is calibrated.

- orifice
- valve stem
- plunger assembly
- lower guide spring
- valve seat

Calibration of the Model 5964/5850EM mass flow controller requires the use of a digital voltmeter (DVM) and a precision flow standard calibrator such as the Brooks Instrument's Vol-U-Meter. It is recommended that the calibration be performed only by trained and qualified service personnel. The recommended flow circuit for performing zero, adjustments, calibration and troubleshooting is shown in Figure 3-13.

If the mass flow controller is to be used on a gas other than the calibration gas, apply the appropriate gas conversion factor, (Refer to Section 4-5). Size the orifice for actual operating conditions (Refer to Section 4-6).

If older Brooks' secondary electronics, Models 5878, 5876 and 5896, are being used as a power supply during the calibration, the 5 Volt reference must be enabled on the card edge version for proper operation. Remember to deactivate the 5 Volt reference before installing the calibrated mass flow controller in the system where Terminal 10 is grounded.

**⚠ CAUTION**

**Do not ground 5 Volt reference output when it is enabled. Improper operation of the printed circuit board will result.**

There are three fundamentally different printed circuit boards used on the Model 5964/5850EM depending on line pressure and full scale flow rate. The enhanced response PC Board is the primary board and is used for all Nitrogen equivalent full scale flow rates above 50 sccm with line pressures less than 150 psig. The settling time specification for the enhanced response PC Board is one second. The second type of PC Board is the standard response PC Board with a settling time of three seconds. The enhanced response PC Board can be identified by five adjustment potentiometers versus four potentiometers on the standard response PC board. The third type of PC Board is the Current I/O version which also has a settling time of three seconds.

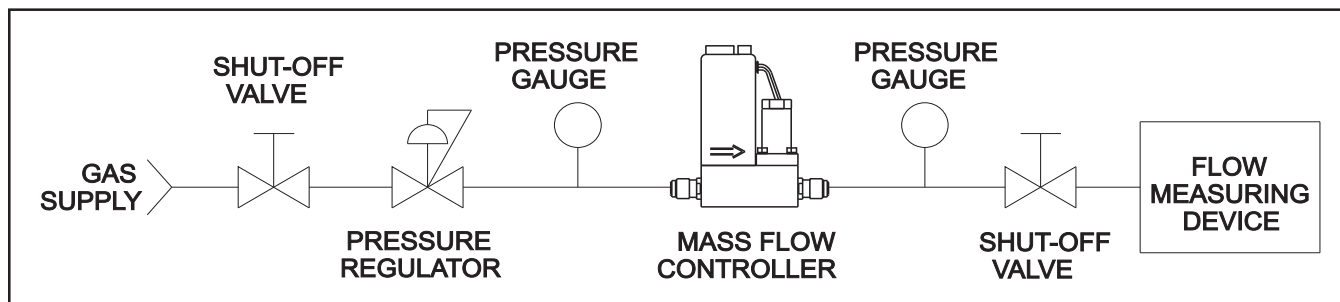

Figure 3-13 Bench Troubleshooting Circuit

## Brooks® Models 5964, 5850EM

When calibrating the Current I/O Version, it is easiest to calibrate using 0-5 Vdc command and flow signals and follow the standard response procedure. Refer to Section 3-4, Features, Current I/O Version, for proper hookups. After calibration, the Model 5964/5850EM may be reconfigured for Current I/O operation with negligible change in calibration.

### Calibration Procedure for the Enhanced Response PC Board (5 adjustment potentiometers)

- a. With the controller installed in an unpressurized gas line, apply power and allow approximately 45 minutes for warm-up. During the warm-up, adjustment, and calibration check procedures, do not allow the control valve to drift when gas flow is not present. This situation is not a normal operating mode and will cause abnormal heat-up of the control valve. With this abnormally warm valve, the meter will be difficult to calibrate. This situation can be prevented by switching a normally closed valve to valve override closed or a normally open valve to valve override open when there is no gas flow.
- b. Rough-adjust the anticipate and response potentiometers fully clockwise 20 turns. Then adjust the anticipate and response potentiometers 10 turns counterclockwise. This provides a rough adjustment of this circuit and makes the flow more stable for calibration.
- c. Adjust zero by connecting the DVM (digital voltmeter) positive lead to the 0-5 Volt output, (Pin 3 Card Edge, Pin 2 D-Connector) and the negative lead to TP4 (circuit common). Adjust the zero potentiometer (second pot from the bottom) for an output of zero mV  $\pm$  2 mV.
- d. Apply pressure to the system and insure that the zero signal repeats within 2 mV of the voltage set in Step c above. If the zero does not repeat, check for leakage.

Note: Controllers with all metal or Teflon valve seats do not provide tight shut-off. A 0-8% leak through is typical. For metal and Teflon seat controllers, close a downstream shut-off valve and observe the flow signal.

- e. Set the command potentiometer for 100% flow (5.000 V). Connect the DVM positive lead to TP2 (linearity voltage) and the negative lead to TP4 (circuit common). Adjust the linearity potentiometer for an output of 0.0 V (zero Volts). As an alternative, you can turn the linearity potentiometer 25 turns counterclockwise.
- f. Read the full scale sensor voltage and flowrate. Prior to taking the measurement, allow a minimum of two minutes for the flow to stabilize. Connect the DVM positive lead to TP1 and the negative lead to TP0. Measure and record the voltage. If the flowrate is within specification, skip to Step h.
- g. Obtain the correct flowrate at 100% command by adjusting the span potentiometer, and calculate the new sensor voltage using the following equation:

$$\text{New Sensor (TP1) voltage} = \frac{\text{measured Sensor (TP1) voltage}}{\text{measured flow rate}} \times \text{desired flow rate}$$

Adjust the span potentiometer until the TP1 to TP0 (sensor voltage) is equal to the value calculated above. Recheck the flow rate after the flow is stable (at least two minutes). Repeat this step until the measured flow rate is within specification. When the flow rate is within specification, record the sensor voltage and proceed to Step h.

Note: The TP1 to TP0 (sensor voltage) can range from about 12 mV to about 120 mV. However, it is recommended that this voltage stay between 20 mV and 90 mV for proper operation. If the recommended voltage range is exceeded, the desired accuracy and/or signal stability may not be achieved. If one of the limits is reached, check the orifice and restrictor sizing using the procedures given in Sections 4-6 and 4-7 respectively.

- h. Set the linearity jumper by adjusting the command potentiometer for 50% flow (2.500 V). Allow at least two minutes for the flow to fully stabilize. Read the flow rate. Calculate the error using the following equation:

$$\text{Error} = 100\% \times \frac{\text{Measured Flow Rate} - \text{Desired Flow Rate}}{\text{Full Scale Flow Rate}}$$

Record the error:

If the error is positive (too much flow), the linearity jumper must be in the (a) position (negative TP2 voltage).

If the error is negative (too little flow), the linearity jumper must be in the (b) position (positive TP2 voltage).

- i. Measure the linearity voltage by setting the command potentiometer to 100% flow (5.000 V) with the DVM positive lead connected to TP2 and the negative lead connected to TP4. The proper full scale linearity voltage can be calculated using the following equation:

$$\text{Full Scale Linearity} = \frac{(-0.0115186 \times \text{error}^2) - (0.2128734 \times \text{error}) + 0.0036597}{\text{full scale flow rate}}$$

Note: Error = The error calculated in Step h.

Adjust the linearity potentiometer until the voltage at TP2 equals the value calculated above.

- k. Readjust the span by allowing the flowrate to stabilize at 100% for at least 30 seconds. Connect the DVM positive lead to TP1 and the negative lead to TP0. Adjust the span potentiometer until the sensor voltage (TP1 to TP0) equals the sensor voltage measured in Step g.
- l. Check the calibration by rechecking zero and adjusting if necessary. Check the flow rate accuracy at 25, 50, 75 and 100% command values.
- m. Adjust the response characteristics. (Refer to Section 3-8).

## Brooks® Models 5964, 5850EM

**Calibration Procedure for the Standard Response and Current I/O PC Board (4 Adjustment Potentiometers)**

- a. With the controller installed in an unpressurized gas line, apply power and allow approximately 45 minutes for warm-up. During the warm-up, adjustment, and calibration check procedures, do not allow the control valve to drift when gas flow is not present. This situation is not a normal operating mode and will cause abnormal heat-up of the control valve. With this abnormally warm valve, the meter will be difficult to calibrate. This situation can be prevented by switching a normally closed valve to valve override closed or a normally open valve to valve override open when there is no gas flow.
- b. Rough adjust the anticipate potentiometer with 20 clockwise full turns. Then, adjust the anticipate potentiometer with 10 counterclockwise turns to center the potentiometer. This will provide a rough adjustment of this circuit and make the flow more stable for calibration.
- c. Connect the DVM positive lead to the 0-5 Volt signal output, (Pin 3 Card Edge, Pin 2 D-Connector) and the negative lead to TP4 (circuit common). Adjust the zero potentiometer for an output of zero mV  $\pm$ 2 mV.
- d. Apply pressure to the system and insure that the zero signal repeats within 2 mV of the voltage set in Step c above. If the zero does not repeat, check for leakage.

Note: Controllers supplied with all metal or Teflon valve seats do not provide tight shut-off. A 0-8% leak-through is typical. For metal or Teflon seat controllers, close a downstream shut-off valve and observe the flow signal.

- e. Set the command potentiometer for 100% of flow (5.000 V). Connect the DVM positive lead to TP2 (linearity voltage) and the negative lead to TP4 (circuit common). Adjust the linearity potentiometer for an output of 0.0 V (zero volts).
- f. Connect the DVM positive lead to TP1 (-100x sensor voltage) and the negative lead to TP4 (circuit common). The command potentiometer should still be set at 100% flow (5.000 V). Measure the flow rate using suitable volumetric calibration equipment. To adjust the controller to the proper full scale flow, calculate a new TP1 voltage using the following equation:

$$\text{New TP1 Voltage} = \frac{\text{measured TP1 voltage}}{\text{measured flow rate}} \times \text{desired flow rate}$$

Adjust the span potentiometer until the voltage at TP1 is equal to the value calculated above. Recheck the flow rate after the flow is stable (at least two minutes). Repeat this check and adjustment procedure until the measured flow rate is within 1% of the desired flow rate.

Note: The voltage at TP1 is -100 times the output voltage (+100 times for Current I/O Version) of the sensor. This voltage can range from -1.2 to -12 Volts, however, it is recommended that this voltage stay between -2.0 and -9.0 Volts for proper operation. If the recommended voltage range exceeds the desired range, accuracy and/or signal stability may not be achieved. If one of the limits is reached, check the orifice and restrictor sizing procedures given in Sections 4-6 and 4-7 respectively.

- g. Set the command potentiometer for zero percent of flow. Connect the DVM positive lead to flow signal output (Pin 3 Card Edge, Pin 2 D-Connector) and the negative lead to TP4 (circuit common). Readjust the zero potentiometer for an output of zero mV ±2 mV as necessary.
- h. Set the command potentiometer for 50% of flow (2.500 V) and measure the flow rate. Calculate the error as a percentage of full scale.

$$\text{Full Scale Error} = 100\% \times \frac{\text{Measured Flow Rate} - \text{Desired Flow Rate}}{\text{Full Scale Flow Rate}}$$

Example:

What is the percent of full scale error when full scale is equal to 100 sccm?

Measured flow rate = 48.5 sccm

Desired flow rate = 50.0 sccm

$$\text{Full Scale Error} = 100 \times \frac{(48.5 - 50)}{100} = -1.5\%$$

- i. Calculate the TP2 correction voltage:  
error calculated in Step h x 0.450 Volts
- Example:  
Error = -1.5%  
TP2 correction voltage = -1.5 x 0.450 = -0.675 Volts  
New TP2 voltage = zero volts + (-0.675) = -0675 Volts
- j. Set the command potentiometer for 100% flow (5.000 V). Connect the DVM positive lead to TP2 (linearity voltage) and the negative lead to TP4 (circuit common).
- k. Adjust the linearity potentiometer for an output equal to the new calculated TP2 voltage.
- l. Repeat Steps f, g and h.
  - l1. If the error calculated in Step h is less than 0.5%, then the calibration procedure is complete.
  - l2. If the error is greater than 0.5%, set the command potentiometer for 100% (5.000 V). Connect the DVM positive lead to TP2 (linearity voltage) and the negative lead to TP4 (circuit common). Calculate a new TP2 voltage as follows employing the measured TP2 voltage:

$$\text{New TP2 voltage} = \frac{\text{error calculated in Step h}}{\text{Step h}} \times 0.450\text{V} + \text{measured TP2 voltage}$$

Example:

Controller error = 0.7%

Measured TP2 voltage = -0.567 Volts

TP2 correction = 0.7 x 0.450 = 0.315 Volts

New TP2 correction = 0.315 + (-0.567) = -0.252 Volts

Adjust the linearity potentiometer for an output equal to the new TP2 correction voltage and then repeat Steps f, g and h.

## Brooks® Models 5964, 5850EM

Note: The voltage at TP2 can range from -10 to +3 Volts. It is recommended, however, that this voltage stay between -2.5 and +2.5 Volts for proper operation. If the recommended voltage range is exceeded, the desired accuracy and/or signal stability may not be achieved. If one of the limits is reached, check the restrictor sizing in Section 4-7.

### 3-8 Response Adjustment

This section describes the procedure for step response adjustment. For enhanced response PC Boards (5 potentiometers) follow either one of the enhanced response procedures. For standard response PC Boards (4 potentiometers) follow either one of the standard response procedures. Two methods of adjusting the step response on the enhanced or standard response PC boards of the Model 5964/5850EM mass flow controller can be used.

Adjustment #1 describes a method that will get the step response close to optimum quickly and without any flow measuring equipment. This method should be used when the response time of the flow controller is not critical to overall system performance.

Adjustment #2 describes a method that will allow adjustment of your Model 5964/5850EM mass flow controller to optimum step response performance. This method is the preferred way to adjust the step response.

Adjustment of the response circuit will not affect the accuracy of the flow controller as adjusted in Section 3-7.

Note: The output voltage shown in Figure 3-14 is based on a controller equipped with an elastomeric seat. For a metal valve seat a positive offset up to 400 mV can be expected for a zero command.

#### Enhanced Response PC Board Adjustment #1

(specification not guaranteed)

Note: This procedure requires an oscilloscope, chart recorder or a DVM - with a sample speed of three samples, or greater, per second to monitor the rate of change of the output signal.

- a. Set the command potentiometer for 100% of flow (5.000 V) and wait about 30 seconds for the flow output signal to stabilize.
- b. Step the command signal to zero percent or activate valve override closed to stop the flow. Observe the flow signal output as it decays.
- c. The behavior of the flow signal during this transition between 100% and zero percent flow indicates the adjustment required of the anticipate potentiometer. Refer to Figure 3-14.

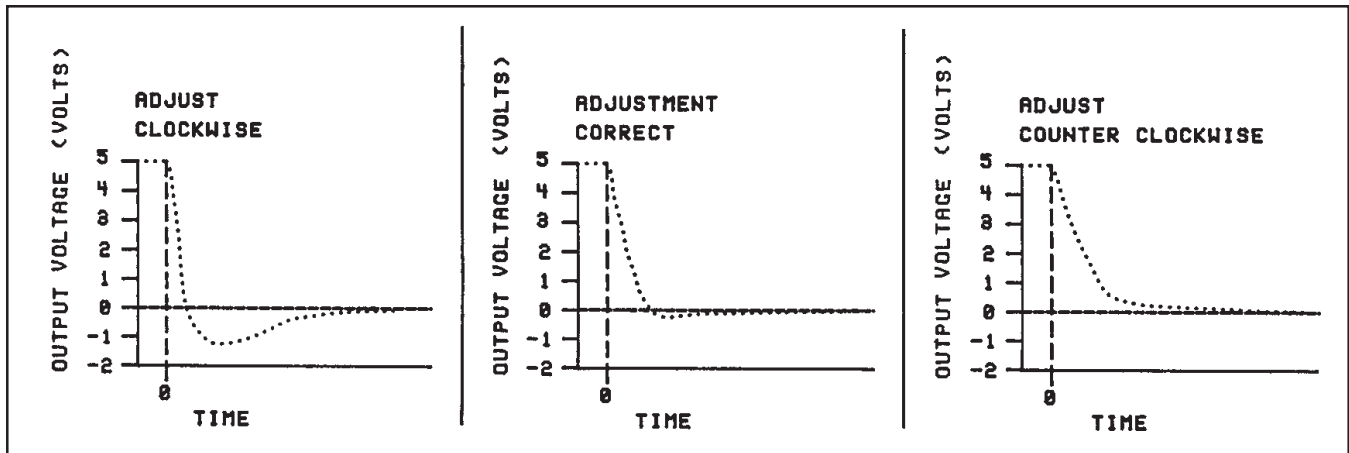

Figure 3-14 Response Adjustment

- c1. If the flow signal decays to -0.05 to -0.5 Volt, then rises to zero Volts, the anticipate potentiometer properly adjusted.
- c2. If the flow signal decays rapidly and goes below -0.5 Volt before rising to zero Volt, the anticipate potentiometer must be adjusted clockwise and Steps a and b repeated.
- c3. If the flow signal decays slowly and does not go below -0.5 Volt, the anticipate potentiometer must be adjusted counterclockwise and Steps a and b repeated.

### Enhanced Response PC Board Adjustment #2

(specification guaranteed)

Note: Adjustment of the response circuitry to obtain a flow performance to be within 2% of final value in less than one second after command change of 0-100% requires the use of a *fast response flowmeter* (less than 100 millisecond response to within 0.2% of final value) in series with the Model 5964/5850EM and a storage oscilloscope or recorder.

- a. Set the command to zero percent flow rate (0.000 V) and allow the flow signal output to stabilize (30 seconds minimum). Step change the command to 100% of flow (5.000 V) and record the output signal from the *fast response flowmeter*.
- b. This flow signal should overshoot above the final value, then overshoot below the final value.
  - b1. If the signal from the *fast response flowmeter* does not overshoot the final value and/or the signal does not reach and stay within  $\pm 2\%$  of final value within 1 second, adjust the anticipate potentiometer one-half to one turn clockwise. If this signal does overshoot above the final value then overshoots below the final value by more than 2%, the anticipate potentiometer must be adjusted one-half to one turn clockwise.
  - b2. If the signal from the *fast response flowmeter* overshoots above the final value by more than 2% and does not overshoot below the final value, then the anticipate potentiometer must be adjusted one-half to one turn counterclockwise.

## Brooks® Models 5964, 5850EM

- c. Repeat Steps a and b above until no further anticipate potentiometer adjustment is necessary.
- d. If the response time and overshoot are not within the required limits, the response potentiometer must be adjusted to control the amount of overshoot. Set the command to 0% flow rate (0.000 V) and allow the flow signal output to stabilize (30 seconds minimum). Step change the command to 100% (5.000 V) and record the output signal from the *fast response flowmeter*.
  - d1. If this signal shows excessive overshoot above the final value, adjust the response potentiometer 2 to 3 turns counterclockwise.
  - d2. If this signal shows that the overshoot above the final value is not excessive, adjusting the response potentiometer one-half to one turn clockwise will speed up the response with correspondingly more overshoot and may also significantly reduce the dead-time between application of a change in command and the first noticeable change in flowrate.
- e. Repeat Step d above until no further adjustment of the response potentiometer is necessary. If the desired response characteristics are still not achieved, some additional improvement can be realized by making adjustments to the flow control valve. Refer to Section 4-4.

**Standard Response and Current I/O PC Board Adjustment #1**

(specification not guaranteed)

Note: This procedure requires an oscilloscope, chart recorder or a DVM with a sample speed of three samples, or greater, per second to monitor the rate of change of the output signal.

- a. Set the command potentiometer for 100% of flow (5.000 V) and wait about 30 seconds for the flow output signal to stabilize.
- b. Step the command signal to zero percent or activate valve override closed to stop the flow. Observe the flow signal output as it decays.
- c. The behavior of the flow signal during this transition between 100% and zero percent flow indicates the adjustment required of the anticipate potentiometer. Refer to Figure 3-14.
  - c1. If the flow signal decays to -0.05 to -0.5 Volt, then rises to zero Volt, the anticipate potentiometer is properly adjusted.
  - c2. If the flow signal decays rapidly and goes below -0.5 Volt before rising to zero Volt, the anticipate potentiometer must be adjusted clockwise and Steps a and b repeated.
  - c3. If the flow signal decays slowly and does not go below -0.5 Volt, the anticipate potentiometer must be adjusted counterclockwise and Steps a and b repeated.



**Standard Response and Current I/O PC Board Adjustment #2**

(specification guaranteed)

Note: Adjustment of the anticipate potentiometer to obtain a flow rate performance to be within 2% of flow rate commanded in less than three seconds (six seconds for Current I/O Version) after command change requires the use of a *fast response flowmeter* (500 millisecond response to be within 0.2% of final value or better) in series with the Model 5850EM and a storage oscilloscope or recorder.

- a. Make a step change in command to the controller from zero to 100% of full scale flow and record the output signal of the *fast response flowmeter*.
- b. If this signal shows more than 4% overshoot, adjust the anticipate potentiometer one-half to one turn counterclockwise. If the signal does not show overshoot, but is not within 2% full scale of final value after three seconds, adjust the anticipate potentiometer one-half to one turn clockwise. Set the command potentiometer for zero percent of flow.
- c. Repeat Steps a and b until the *fast response flowmeter* output signal meets the specified response requirements.

*THIS PAGE WAS  
INTENTIONALLY  
LEFT BLANK*

**4-1 Overview**

	<p><b>⚠ WARNING</b></p> <p><b>METER/CONTROLLER SEAL COMPATIBILITY</b></p>
---	---

Products in this manual may contain metal or elastomeric seals, gaskets, O-rings or valve seats. It is the "user's" responsibility to select materials that are compatible with their process and process conditions. Using materials that are not compatible with the process or process conditions could result in the Meter or Controller leaking process fluid outside the pressure boundary of the device, resulting in personnel injury or death.

It is recommended that the user check the Meter or Controller on a regular schedule to ensure that it is leak free as both metal and elastomeric seals, gaskets, O-rings and valve seats may change with age, exposure to process fluid, temperature, and /or pressure.

**⚠ WARNING**

If it becomes necessary to remove the instrument from the system power to the device is disconnected at the power supply.

**⚠ WARNING**

If it becomes necessary to remove the flowmeter from the system after exposure to toxic, pyrophoric, flammable or corrosive gas, purge the flowmeter thoroughly with a dry inert gas such as Nitrogen before disconnecting the gas connections. Failure to correctly purge the flowmeter could result in fire, explosion or death. Corrosion or contamination of the flowmeter upon exposure to air, may also occur.

**⚠ CAUTION**

It is important that this MFC/MFM only be serviced by properly trained and qualified personnel.

## Brooks® Models 5964, 5850EM

No routine maintenance is required on the Model 5964/5850EM. If an in-line filter is used, the filtering element should periodically be replaced.

This section provides the following information:

- Troubleshooting
- Cleaning
- Control Valve Adjustment
- Gas Conversion Factors
- Orifice Sizing
- Restrictor Sizing

## 4-2 Troubleshooting

### **⚠ CAUTION**

**It is important that this controller only be serviced by properly trained and qualified personnel.**

#### **A. System Checks**

The Model 5964/5850EM is generally used as a component in gas handling systems which can be quite complex. This can make the task of isolating a malfunction in the system a difficult one. An incorrectly diagnosed malfunction can cause many hours of unnecessary downtime. If possible, make the following system checks before removing a suspected defective mass flow controller for bench troubleshooting or return, especially if the system is new.

1. Verify a low resistance common connection, correct power supply voltage and that signals are reaching and leaving the controller. The breakout board, P/N S273Z649AAA Card Edge version or P/N S273Z668AAA D-Connector version listed in Section 5, will make this job much easier.
2. Verify that the process gas connections have been correctly terminated and leak-checked.
3. If the mass flow controller appears to be functioning but cannot achieve set-point, verify that sufficient inlet pressure and pressure drop are available at the controller to provide the required flow.
4. Verify that all user selectable jumpers are in their desired positions. Refer to Figures 3-5 through 3-9.

### **⚠ WARNING**

**If it becomes necessary to remove the controller from the system after exposure to toxic, pyrophoric, flammable or corrosive gas, purge the controller thoroughly with a dry inert gas such as Nitrogen before disconnecting the gas connections. Failure to correctly purge the controller could result in fire, explosion or death. Corrosion or contamination of the mass flow controller, upon exposure to air, may also occur.**

### B. Bench Troubleshooting

In order to assist in troubleshooting it is highly recommended that the controller be installed in a flow circuit as shown in Figure 3-13.

1. Properly connect the mass flow controller to a  $\pm 15$  Vdc power supply or a +15 to +28 Vdc in the case of a current I/O board. Connect a command voltage source and an output signal readout device (4-1/2 digit voltmeter recommended) to Pins 2 and 3 on the Card Edge version, or Pins 2 and 10 for the D-Connector version (Refer to Figure 2-2, 2-3, 2-4 or 2-6). Apply power, set the command voltage to zero and allow the controller to warm-up for 45 minutes. Do not connect to a gas source at this time.

Observe the output signal and, if necessary, perform the zero adjustment procedure (Section 3-6). If the output signal will not zero properly, refer to the sensor troubleshooting section and check the sensor. If the sensor is electrically functional, the printed circuit board is defective and will require replacement.

2. Connect the controller to a source of the gas on which it was originally calibrated. Command 100% flow and adjust the inlet and outlet pressures to the calibration conditions. Verify that the output signal reaches and stabilizes at 5.000 Volts. Vary the command voltage over the control range and verify that the output signal follows the command input.

Apply +15 Volts to the valve override input, (Pin 9 for the Card Edge version, Pin 12 for D-Connector version) and verify that the output exceeds 5.000 Volts.

Apply -15 Volts to the valve override terminal and verify that the output signal falls below 0.100 Volts for an elastomeric valve seat and below 400 Volts for a metal valve seat. If the controller is connected in series with a suitable flow standard, observe the actual flow behavior and verify the accuracy of the mass flow controller. If the mass flow controller functions as described above, it is functioning properly and the problem is most likely elsewhere. Table 4-1 lists possible malfunctions which may be encountered during bench troubleshooting.

### C. Sensor Troubleshooting

If it is believed the sensor coils are either open or shorted, troubleshoot using Table 4-2. If any of the steps do not produce expected results, the sensor assembly is defective. Return to Brooks Instrument for sensor replacement.

Note: Do not attempt to disassemble the sensor.

### D. Cleaning Procedures

No routine external cleaning is required for Brooks thermal mass flow controller. Should the Models 5964 or 5850EM Mass Flow Controller require cleaning due to deposition, return the device to Brooks Instrument for servicing by trained technicians.

## Brooks® Models 5964, 5850EM

Table 4-1 Bench Troubleshooting

Trouble	Possible Cause	Check/Corrective Action
Actual flow overshoots setpoint by more than 5% full scale.	Anticipate potentiometer out of adjustment.	Adjust anticipate potentiometer. Refer to Sections 3-5 & 3-8 .
Output stays at zero level regardless of command and there is no flow through the controller.	Clogged Sensor tube and restrictor and/or a clogged orifice. Closed or clogged flow path up- or downstream or the controller. Clogged Control Valve. Internal reference being used as the command source and the yellow jumper is in the wrong position. -15 volts applied to the valve override input Defective printed circuit board. Valve voltage not returned, Pin L at common. "Valve-off" pin grounded.	Clean sensor. Refer to cleaning procedure, Section 4-2D. Open valve(s). Clean filter(s). Remove any foreign material from gas delivery system. Check TP3 with the command at 100%. If the voltage is more negative than -11V, disassemble and repair the control valve. Refer to Sections 4-3 and 4-4. Refer to Section 3-4. Check valve override input. Refer to Section 2-6 for terminal assignments. Replace printed circuit board. Refer to Section 4-3. Check jumper for external valve return. Refer to Section 3-4. Check "Valve-Off" input. Refer to Section 2-6 for terminal assignments.
Output signal stays at +6.8 Volts (26 mA for Current I/O Vers.) regardless of command and there is flow	Valve stuck open or leaky. +15 Volts applied to the valve override input. Defective printed circuit board. Command input floating. Pin D connected to common.	Clean and/or adjust control valve. Refer to cleaning procedure and/or Section 4-2D. Check the valve override terminal. Refer to Section 2-6 for terminal assignments. through the controller. Replace printed circuit board. Refer to Section 4-3. Connect command signal. Refer to Section 2-6 for terminal assignments. Remove Pin D from common.
Output signal follows set-point at higher commands but will not go to zero.	Leaky control valve Excessive resistance in valve voltage return line.	Disassemble and repair valve. Refer to Section 4-3. Reduce wiring resistance or reconfigure controller for "External Valve Return." Refer to Section 3-4.
Output signal follows set-point at lower commands but does not reach full scale.	Insufficient inlet pressure or pressure drop. Partially clogged sensor Partially clogged valve. Valve out of adjustment. Valve guide spring failure.	Adjust pressures, inspect in-line filters and clear/replace as necessary. Check calibration. Refer to Section 3-7. Disassemble and repair control valve. Refer to Section 4-3. Adjust valve. Refer to Section 4-4. Check valve spring.
Controller grossly out of calibration. Flow is higher than desired.	Partially clogged sensor.	Clean sensor. Refer to the cleaning procedure, Section 4-2D.
Controller grossly out of calibration. Flow is lower than desired.	Partially clogged restrictor.	Replace restrictor. Refer to Section 4-3.
Controller oscillates.	Pressure drop or inlet pressure excessive. Oversized orifice. Valve out of adjustment. Anticipate potentiometer out of adjustment. Faulty pressure regulator. Defective printed circuit board.	Adjust pressures. Check orifice size. Refer to Section 4-6. Adjust valve. Refer to Section 4-4. Adjust anticipate potentiometer. Refer to Section 3-8. Check regulator output. Replace printed circuit board. Refer to Section 4-3.

Table 4-2 Sensor Troubleshooting

**SENSOR SCHEMATIC**

PIN NO.	FUNCTION
1	Heater
2	Upstream Temperature Sensor (Su)
3	Downstream Temperature Sensor (Sd)
4	Sensor Common
5	Heater Common

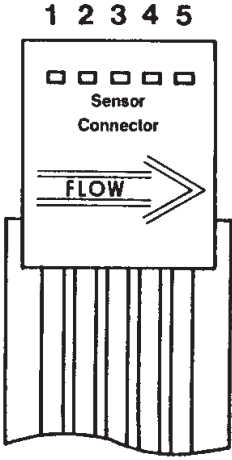

Flex Circuit Wire Numbers

---

**Remove the sensor connector from the PC Board for this procedure.**

OHMMETER CONNECTION	RESULT IF ELECTRICALLY FUNCTIONAL
Pin 1 or 4 to meter body	Open circuit on ohmmeter. If either heater (1) or sensor common (4) are shorted, an ohmmeter reading will be obtained.
Pin 4 to Pin 2	Nominal 1100 ohms reading, depending on temperature and ohmmeter current.
Pin 4 to Pin 3	
Pin 5 to Pin 1	Nominal 1200 ohm reading.

Brooks® Models 5964, 5850EM

**4-3 Gas Conversion Factors**

If a mass flow controller is operated on a gas other than the gas it was calibrated with, a scale shift will occur in the relation between the output signal and the mass flow rate. This is due to the difference in heat capacities between the two gases. This scale shift can be approximated by using the ratio of the molar specific heat of the two gases or by sensor conversion factor. A list of sensor conversion factors is given in Table 4-5. To change to a new gas, multiply the output reading by the ratio of the gas factor for the desired gas by the gas factor for the calibration gas used.

$$\text{Actual Gas Flow Rate} = \text{Output Reading} \times \frac{\text{Factor of the New Gas}}{\text{Factor of the Calibration Gas}}$$

Example:

The controller is calibrated for Nitrogen.

The desired gas is Carbon Dioxide

The output reading is 75 sccm when Carbon Dioxide is flowing

Then  $75 \times 0.773 = 57.98$  sccm

In order to calculate the conversion factor for a gas mixture, the following formula should be used:

$$\text{Sensor Conversion Factor}_{\text{Mixture}} = \frac{100}{P_1} \times \frac{100}{P_2} \times \frac{100}{P_3}$$

$\frac{\text{Sensor Conversion Factor}_1}{\text{Sensor Conversion Factor}_1}$ 
 $\frac{\text{Sensor Conversion Factor}_2}{\text{Sensor Conversion Factor}_2}$ 
 $\frac{\text{Sensor Conversion Factor}_3}{\text{Sensor Conversion Factor}_3}$

Where,

$P_1$  = percentage (%) of gas 1 (by volume)

$P_2$  = percentage (%) of gas 2 (by volume)

$P_n$  = percentage (%) of gas n (by volume)



Table 4-3 Conversion Factors (Nitrogen Base)

GAS NAME	FORMULA	SENSOR FACTOR	ORIFICE FACTOR	DENSITY (kg/m <sup>3</sup> )
Acetylene	C <sub>2</sub> H <sub>2</sub>	0.615	0.970	1.173
Air	Mixture	0.998	1.018	1.293
Allene	C <sub>3</sub> H <sub>4</sub>	0.478	1.199	1.787
Ammonia	NH <sub>3</sub>	0.786	0.781	0.771
Argon	Ar	1.395	1.195	1.784
Arsine	AsH <sub>3</sub>	0.754	1.661	3.478
Boron Trichloride	BCL <sub>3</sub>	0.443	2.044	5.227
Boron Trifluoride	BF <sub>3</sub>	0.579	1.569	3.025
Bromine Pentafluoride	BrF <sub>5</sub>	0.287	2.502	7.806
Bromine Trifluoride	BrF <sub>3</sub>	0.439	2.214	6.108
Bromotrifluoroethylene	C <sub>2</sub> BrF <sub>3</sub>	0.326	2.397	7.165
Bromotrifluoromethane f-13B1	CBrF <sub>3</sub>	0.412	2.303	6.615
1,3-Butadiene	C <sub>4</sub> H <sub>6</sub>	0.354	1.413	2.491
Butane	C <sub>4</sub> H <sub>10</sub>	0.257	1.467	2.593
1-Butene	C <sub>4</sub> H <sub>8</sub>	0.294	1.435	2.503
CIS-2-Butene	C <sub>4</sub> H <sub>8</sub>	0.320	1.435	2.503
Trans-2-Butene	C <sub>4</sub> H <sub>8</sub>	0.291	1.435	2.503
Carbon Dioxide	CO <sub>2</sub>	0.773	1.255	1.977
Carbon Disulfide	CS <sub>2</sub>	0.638	1.650	3.393
Carbon Monoxide	CO	0.995	1.000	1.250
Carbon Tetrachloride	CCL <sub>4</sub>	0.344	2.345	6.860
Carbon Tetrafluoride f-14	CF <sub>4</sub>	0.440	1.770	3.926
Carbonyl Fluoride	COF <sub>2</sub>	0.567	1.555	2.045
Carbonyl Sulfide	COS	0.680	1.463	2.180
Chlorine	CL <sub>2</sub>	0.876	1.598	3.214
Chlorine Dioxide	CLO <sub>2</sub>	0.693	1.554	3.011
Chlorine Trifluoride	CLF <sub>3</sub>	0.433	1.812	4.125
2-Chlorobutane	C <sub>4</sub> H <sub>9</sub> Cl	0.234	1.818	4.134
Chlorodifluoromethane f-22	CHCLF <sub>2</sub>	0.505	1.770	3.906
Chloroform (Trichloromethane)	CHCL <sub>3</sub>	0.442	2.066	5.340
Chloropentafluoroethane f-115	C <sub>2</sub> CLF <sub>5</sub>	0.243	2.397	7.165
Chlorotrifluoroethylene	C <sub>2</sub> CLF <sub>3</sub>	0.337	2.044	5.208
Chlorotrifluoromethane f-13	CCLF <sub>3</sub>	0.430	1.985	4.912
Cyanogen	(CN) <sub>2</sub>	0.498	1.366	2.322
Cyanogen Chloride	CLCN	0.618	1.480	2.730
Cyclobutane	C <sub>4</sub> H <sub>8</sub>	0.387	1.413	2.491
Cyclopropane	C <sub>3</sub> H <sub>6</sub>	0.505	1.224	1.877
Deuterium	D <sub>2</sub>	0.995	0.379	0.177
Diborane	B <sub>2</sub> H <sub>6</sub>	0.448	1.000	1.235
Diboromodifluoromethane f-12B2	CBr <sub>2</sub> F <sub>2</sub>	0.363	2.652	8.768
1,2-Dibromotetrafluoroethane f-114B2	C <sub>2</sub> Br <sub>2</sub> F <sub>4</sub>	0.215	2.905	10.53
Dichlorodifluoromethane f-12	CCL <sub>2</sub> F <sub>2</sub>	0.390	2.099	5.492
Dichlorofluoromethane f-21	CHCL <sub>2</sub> F	0.456	1.985	4.912
Dichlorosilane	SiH <sub>2</sub> CL <sub>2</sub>	0.442	1.897	4.506
1,2-Dichloroethane	C <sub>2</sub> H <sub>4</sub> CL <sub>2</sub>	0.382	1.879	4.419
1,2-Dichlorotetrafluoroethane f-114	C <sub>2</sub> CL <sub>2</sub> F <sub>4</sub>	0.231	2.449	7.479
2,2 Dichloro	C <sub>2</sub> HC <sub>12</sub> F <sub>3</sub>	0.259	2.336	6.829
1,1-Difluoro-1-Chloroethane	C <sub>2</sub> H <sub>3</sub> CLF <sub>2</sub>	0.341	1.957	4.776
1,1-Difluoroethane	CH <sub>3</sub> CHF <sub>2</sub>	0.415	1.536	2.940
1,1-Difluoroethylene	CH <sub>2</sub> :CF <sub>2</sub>	0.458	1.512	2.860
Diethylsilane	C <sub>4</sub> H <sub>12</sub> Si	0.183	1.775	3.940
Difluoromethane f-32	CF <sub>2</sub> H <sub>2</sub>	0.627	1.360	2.411
Dimethylamine	(CH <sub>3</sub> ) <sub>2</sub> NH	0.370	1.269	2.013
Dimethylether	(CH <sub>3</sub> ) <sub>2</sub> O	0.392	1.281	2.055
2,2-Dimethylpropane	C(CH <sub>3</sub> ) <sub>4</sub>	0.247	1.613	3.244
Disilane	Si <sub>2</sub> H <sub>6</sub>	0.332	1.493	2.779
Ethane	C <sub>2</sub> H <sub>6</sub>	0.490	1.038	1.357
Ethanol	C <sub>2</sub> H <sub>5</sub> O	0.394	1.282	2.057
Ethylacetylene	C <sub>4</sub> H <sub>6</sub>	0.365	1.384	2.388
Ethyl Chloride	C <sub>2</sub> H <sub>5</sub> CL	0.408	1.516	2.879

## Brooks® Models 5964, 5850EM

Table 4-3 Conversion Factors (Nitrogen Base) Continued

GAS NAME	FORMULA	SENSOR FACTOR	ORIFICE FACTOR	DENSITY (kg/m <sup>3</sup> )
Ethylene	C <sub>2</sub> H <sub>4</sub>	0.619	1.000	1.261
Ethylene Oxide	C <sub>2</sub> H <sub>4</sub> O	0.589	1.254	1.965
Fluorine	F <sub>2</sub>	0.924	1.163	1.695
Fluoroform f-23	CHF <sub>3</sub>	0.529	1.584	3.127
Germane	GeH <sub>4</sub>	0.649	1.653	3.418
Germanium Tetrachloride	GeCl <sub>4</sub>	0.268	2.766	9.574
Halothane (R-123B1)	C <sub>2</sub> HBrClF <sub>3</sub>	0.257	2.654	8.814
Helium	He	1.386	0.378	0.178
Hexafluoroacetone	F <sub>3</sub> CCOCF <sub>3</sub>	0.219	2.434	7.414
Hexafluorobenzene	C <sub>6</sub> F <sub>6</sub>	0.632	2.577	8.309
Hexafluoroethane f-116	C <sub>2</sub> F <sub>6</sub>	0.255	2.219	6.139
Hexafluoropropylene (HFP)	C <sub>3</sub> F <sub>6</sub>	0.249	2.312	6.663
Hexamethyldisilane (HMDS)	(CH <sub>3</sub> ) <sub>6</sub> Si <sub>2</sub>	0.139	2.404	7.208
Hexane	C <sub>6</sub> H <sub>14</sub>	0.204	1.757	3.847
Hydrogen	H <sub>2</sub>	1.008	0.269	0.090
Hydrogen Bromide	HBr	0.987	1.695	3.645
Hydrogen Chloride	HCL	0.983	1.141	1.639
Hydrogen Cyanide	HCN	0.744	0.973	1.179
Hydrogen Fluoride	HF	0.998	0.845	0.893
Hydrogen Iodide	HI	0.953	2.144	5.789
Hydrogen Selenide	H <sub>2</sub> Se	0.837	1.695	3.613
Hydrogen Sulfide	H <sub>2</sub> S	0.850	1.108	1.539
Iodine Pentafluoride	IF <sub>5</sub>	0.283	2.819	9.907
Isobutane	C <sub>4</sub> H <sub>10</sub>	0.260	1.440	2.593
Isobutene	C <sub>4</sub> H <sub>8</sub>	0.289	1.435	2.503
Isopentane	C <sub>5</sub> H <sub>12</sub>	0.211	1.605	3.222
Krypton	Kr	1.382	1.729	3.708
Methane	CH <sub>4</sub>	0.763	0.763	0.717
Methylacetylene	C <sub>3</sub> H <sub>4</sub>	0.473	1.196	1.782
Methyl Bromide	CH <sub>3</sub> Br	0.646	1.834	4.236
3-Methyl-1-butene	C <sub>5</sub> H <sub>10</sub>	0.252	1.584	3.127
Methyl Chloride	CH <sub>3</sub> CL	0.687	1.347	2.308
Methyl Fluoride	CH <sub>3</sub> F	0.761	1.102	1.518
Methyl Mercaptan	CH <sub>3</sub> S	0.588	1.313	2.146
Methyl Silane	CH <sub>3</sub> Si	0.393	1.283	2.061
Methyl Trichlorosilane (MTS)	CH <sub>3</sub> Cl <sub>3</sub> Si	0.267	2.310	6.675
Methyl Vinyl Ether	C <sub>3</sub> H <sub>6</sub> O	0.377	1.435	2.567
Monoethanolamine	C <sub>2</sub> H <sub>7</sub> NO	0.305	1.477	2.728
Monoethylamine	C <sub>2</sub> HH <sub>3</sub> NH <sub>2</sub>	0.359	1.269	2.013
Monomethylamine	CH <sub>3</sub> NH <sub>2</sub>	0.565	1.067	1.420
Neon	Ne	1.398	0.847	0.902
Nickel Carbonyl	Ni(CO) <sub>4</sub>	0.212	2.371	7.008
Nitric Oxide	NO	0.995	1.030	1.339
Nitrogen	N <sub>2</sub>	1.000	1.000	1.251
Nitrogen Dioxide	NO <sub>2</sub>	0.758	1.713	2.052
Nitrogen Trifluoride	NF <sub>3</sub>	0.501	1.598	3.168
Nitrogen Trioxide	N <sub>2</sub> O <sub>3</sub>	0.443	1.649	3.389
Nitrosyl Chloride	NOCL	0.644	1.529	2.913
Nitrous Oxide	N <sub>2</sub> O	0.752	1.259	1.964
Octofluorocyclobutane	C <sub>4</sub> F <sub>8</sub>	0.169	2.672	8.933
Oxygen	O <sub>2</sub>	0.988	1.067	1.429
Oxygen Difluoride	OF <sub>2</sub>	0.672	1.388	2.402
Ozone	O <sub>3</sub>	0.738	1.310	2.138
Pentafluorethane f-125	C <sub>2</sub> HF <sub>5</sub>	0.287	2.070	5.360
Pentane (n-Pentane)	C <sub>5</sub> H <sub>12</sub>	0.212	1.605	3.222
Perchloryl Fluoride	CLO <sub>3</sub> F	0.448	1.905	4.571
Perfluorobutane	C <sub>4</sub> F <sub>10</sub>	0.738	2.918	10.61
Perfluoro-2-Butene	C <sub>4</sub> F <sub>8</sub>	0.268	2.672	8.933
Perfluoromethyl-vinylether	PMVE	0.296	2.029	5.131
Perfluoropropane	C <sub>3</sub> F <sub>8</sub>	0.179	2.591	8.396

Table 4-3 Conversion Factors (Nitrogen Base) Continued

GAS NAME	FORMULA	SENSOR FACTOR	ORIFICE FACTOR	DENSITY (kg/m <sup>3</sup> )
Pentane (n-Pentane)	C <sub>5</sub> H <sub>12</sub>	0.212	1.605	3.222
Phosgene	COCL <sub>2</sub>	0.504	1.881	4.418
Phosphine	PH <sub>3</sub>	0.783	1.100	1.517
Phosphorous Pentafluoride	PF <sub>5</sub>	0.346	2.109	5.620
Phosphorous Trifluoride	PF <sub>3</sub>	0.495	1.770	3.906
Propane (same as CH <sub>3</sub> CH <sub>2</sub> CH <sub>3</sub> )	C <sub>3</sub> H <sub>8</sub>	0.343	1.274	2.008
Propylene (Propene)	C <sub>3</sub> H <sub>6</sub>	0.401	1.234	1.875
Rhenium Hexafluoride	ReF <sub>6</sub>	0.230	3.279	13.41
Silane	SiH <sub>4</sub>	0.625	1.070	1.440
Silicon Tetrachloride	SiCL <sub>4</sub>	0.310	2.465	7.579
Silicon Tetrafluoride	SiF <sub>4</sub>	0.395	1.931	4.648
Sulfur Dioxide	SO <sub>2</sub>	0.728	1.529	2.858
Sulfur Hexafluoride	SF <sub>6</sub>	0.270	2.348	6.516
Sulfur Tetrafluoride	SF <sub>4</sub>	0.353	1.957	4.776
Sulfur Trioxide	SO <sub>3</sub>	0.535	1.691	3.575
Sulfuryl Fluoride	SO <sub>2</sub> F <sub>2</sub>	0.423	1.931	4.648
Tetrachloromethane	CCL <sub>4</sub>	0.344	2.345	6.858
Tetrafluoroethylene (TFE)	C <sub>2</sub> F <sub>4</sub>	0.361	1.905	4.526
Tetrafluorohydrazine	N <sub>2</sub> F <sub>4</sub>	0.367	1.926	4.624
Trichlorofluoromethane f-11	CCL <sub>3</sub> F	0.374	2.244	6.281
Trichlorosilane	SiHCL <sub>3</sub>	0.329	2.201	6.038
Trimethyloxyborane (TMB)	B(OCH <sub>3</sub> ) <sub>3</sub>	0.300	1.929	4.638
1,1,2-Trichloro-1,1,2-Trifluoroet f-113	C <sub>2</sub> CL <sub>3</sub> F <sub>3</sub>	0.231	2.520	7.920
Trimethylamine	(CH <sub>3</sub> ) <sub>3</sub> N	0.316	1.467	2.639
Tungsten Hexafluoride	WF <sub>6</sub>	0.227	3.264	13.28
Uranium Hexafluoride	UF <sub>6</sub>	0.220	3.548	15.70
Vinyl Bromide	C <sub>2</sub> H <sub>3</sub> Br	0.524	1.985	4.772
Vinyl Chloride	C <sub>2</sub> H <sub>3</sub> CL	0.542	1.492	2.788
Vinyl Fluoride	C <sub>2</sub> H <sub>3</sub> F	0.576	1.281	2.046
Water Vapor	H <sub>2</sub> O	0.861	0.802	0.804
Xenon	Xe	1.383	2.180	5.851

Ref. No. J-836D508 Gasdata.doc Vsn. 8.6

Example: The desired gas is 20% Helium (He) and 80% Chlorine (Cl) by volume. The desired full scale flow rate of the mixture is 20 slpm. Sensor conversion factor for the mixture is:

$$\text{Mixture Factor} = \frac{100}{\frac{20}{1.386} + \frac{80}{.876}} = .945$$

Nitrogen equivalent flow = 20/.945 = 21.16 slpm Nitrogen

It is generally accepted that the mass flow rate derived from this equation is only accurate to ±5%. The sensor conversion factors given in Table 4-3 are calculated based on a gas temperature of 21°C and a pressure of one atmosphere. The specific heat of most gases is not strongly pressure, and/or temperature, dependent. However, gas conditions that vary widely from these reference conditions may cause an additional error due to the change in specific heat caused by pressure and/or temperature.

## Brooks® Models 5964, 5850EM

## 4-4 Orifice Sizing

The Orifice Sizing Nomograph, Figure 4-1, is used to calculate the control valve's orifice size when changing any or all of the following factors from the original factory calibration:

**gas**  
**operating pressure (inlet and outlet)**  
**flow range**

The flow controller's orifice is factory-sized to a preselected gas, operating pressure and flow range. Note that the orifice is marked with its size in thousandths of an inch. When changing the aforementioned factors, calculate the new orifice size by following the procedure and example outlined in the following paragraphs.

**Example: Determine the orifice size for the following conditions:**

Gas: Hydrogen  
 Flow Rate: 2,000 sccm  
 Outlet Pressure: 30 psig  
 Inlet Pressure: 50 psig

1. Determine Nitrogen equivalent flow rate (refer to Table 4-3).

$$Q_{\text{NITROGEN}} = Q_{\text{GAS}} \times \sqrt{\frac{\rho_{\text{GAS}}}{\rho_{\text{NITROGEN}}}}$$

OR

$$Q_{\text{NITROGEN}} = Q_{\text{GAS}} \times \sqrt{\frac{\text{SG}_{\text{GAS}}}{\text{SG}_{\text{NITROGEN}}}}$$

Where:

$Q_{\text{NITROGEN}}$  = Nitrogen equivalent flow rate (sccm)

$Q_{\text{GAS}}$  = Desired flow rate of the gas (sccm)

$\rho_{\text{NITROGEN}}$  = Density of Nitrogen at 70°F

$\rho_{\text{GAS}}$  = Density of the gas (taken at customer temperature)

$\text{SG}_{\text{GAS}}$  = Specific gravity of the gas (taken at customer temperature)

Refer to Table 4-5 for densities.

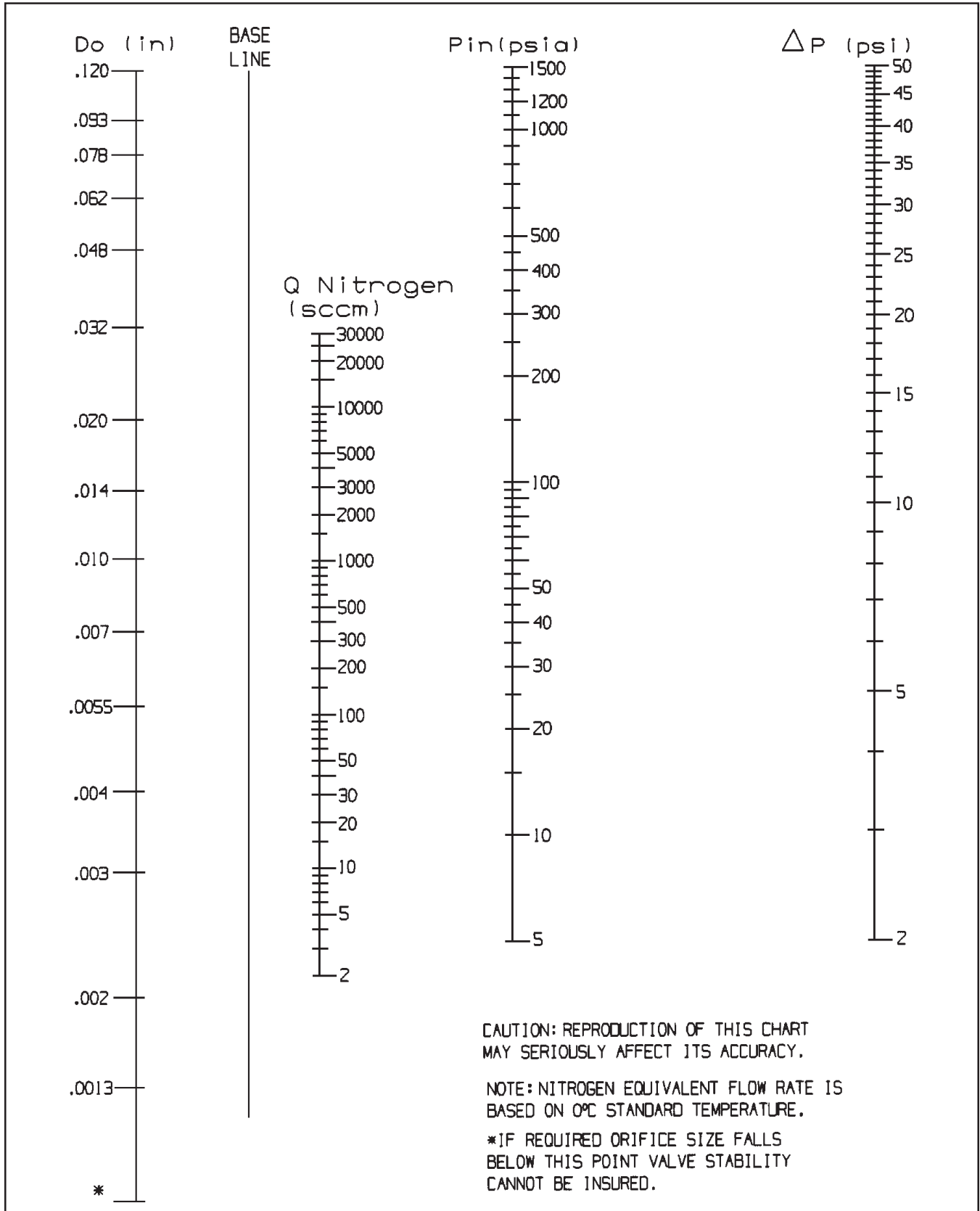

Figure 4-1 Model 5850EM Orifice Sizing Nomograph

## Brooks® Models 5964, 5850EM

Example:

$$\begin{aligned}
 Q_{\text{gas}} &= 2,000 \text{ sccm} \\
 \sqrt{\frac{P_{\text{GAS}}}{P_{\text{NITROGEN}}}} &= .269 \\
 Q_{\text{NITROGEN}} &= Q_{\text{GAS}} \times \sqrt{\frac{P_{\text{GAS}}}{P_{\text{NITROGEN}}}} \\
 &= 2,000 \times .269 \\
 &= 538 \text{ sccm Nitrogen}
 \end{aligned}$$

In order to calculate the orifice conversion factor when using a gas mixture, the following formula must be used:

$$\text{Orifice Conversion Factor Mixture} = \sqrt{\frac{P_1 \left( \text{Orifice Conversion Factor 1} \right) + P_2 \left( \text{Orifice Conversion Factor 2} \right) + P_n \left( \text{Orifice Conversion Factor n} \right)}{100}}$$

Where  $P_1$  = percentage by volume of gas 1  
 $P_2$  = percentage by volume of gas 2  
 $P_n$  = percentage by volume of gas n

Example: Find the Nitrogen equivalent for 20 slpm of a 20% Helium and 80% Chlorine gas mixture.

$$\begin{aligned}
 \text{Orifice Conversion Factor Mixture} &= \frac{20(.378)}{100} + \frac{80(1.598)}{100}
 \end{aligned}$$

$$\begin{aligned}
 Q_{\text{Nitrogen}} &= Q_{\text{gas}} (\text{orifice conversion factor}) \\
 &= 20 \times 1.439 \\
 &= 28.78 \text{ slpm Nitrogen}
 \end{aligned}$$

- If inlet and outlet pressures are given in gauge pressure (psig) add 14.7 to convert to absolute pressure (psia).

$$\begin{aligned}
 \text{Outlet Pressure} &\text{ — } 30 \text{ psig} + 14.7 = 44.7 \text{ psia} \\
 \text{Inlet Pressure} &\text{ — } 50 \text{ psig} + 14.7 = 64.7 \text{ psia}
 \end{aligned}$$

3. Determine Critical Pressure Drop

Critical pressure drop occurs when the outlet pressure (psia) is less than half the inlet pressure (psia) or

$$P_{\text{outlet}} < \frac{P_{\text{inlet}}}{2}$$

If these conditions exist, the pressure drop (Dp) should be calculated as follows:

$$Dp = \frac{P_{\text{in}}}{2}$$

Dp = Pressure drop (psi)  
 P<sub>in</sub> = Inlet pressure (psia)

If these conditions do not exist, pressure drop equals the inlet pressure minus the outlet pressure.

$$\text{Is } 44.7 \text{ psia} < \frac{64.7 \text{ psia}}{2} \quad ? \quad \text{—} \quad \text{No.}$$

$$\text{Then } Dp = 64.7 - 44.7 = 20 \text{ psi}$$

4. Using the nomograph, locate the pressure drop (psi) on the vertical line marked "Dp" (Point A).
5. Locate the Nitrogen equivalent flow rate (sccm Nitrogen) on the vertical line marked "Q<sub>Nitrogen</sub>" (Point B).
6. Draw a line connecting Dp and Q<sub>Nitrogen</sub> and extend it to the baseline. Mark this point (Point C).
7. Locate inlet pressure (psia) on the vertical line marked "P<sub>in</sub>" (Point D).
8. Draw a line connecting P<sub>in</sub> (Point D) and baseline (Point C) and then extend this line to the vertical line marked D<sub>o</sub> (orifice diameter, inches) (Point E).
9. This point on the line is the minimum orifice size for the given conditions. If this point is between two orifice sizes, select the next largest size orifice to ensure adequate flow. If the orifice selected falls below .0013, choose .0013 size orifice.

For the example in Figure 4-3, the .007 size orifice would be selected.

Brooks® Models 5964, 5850EM

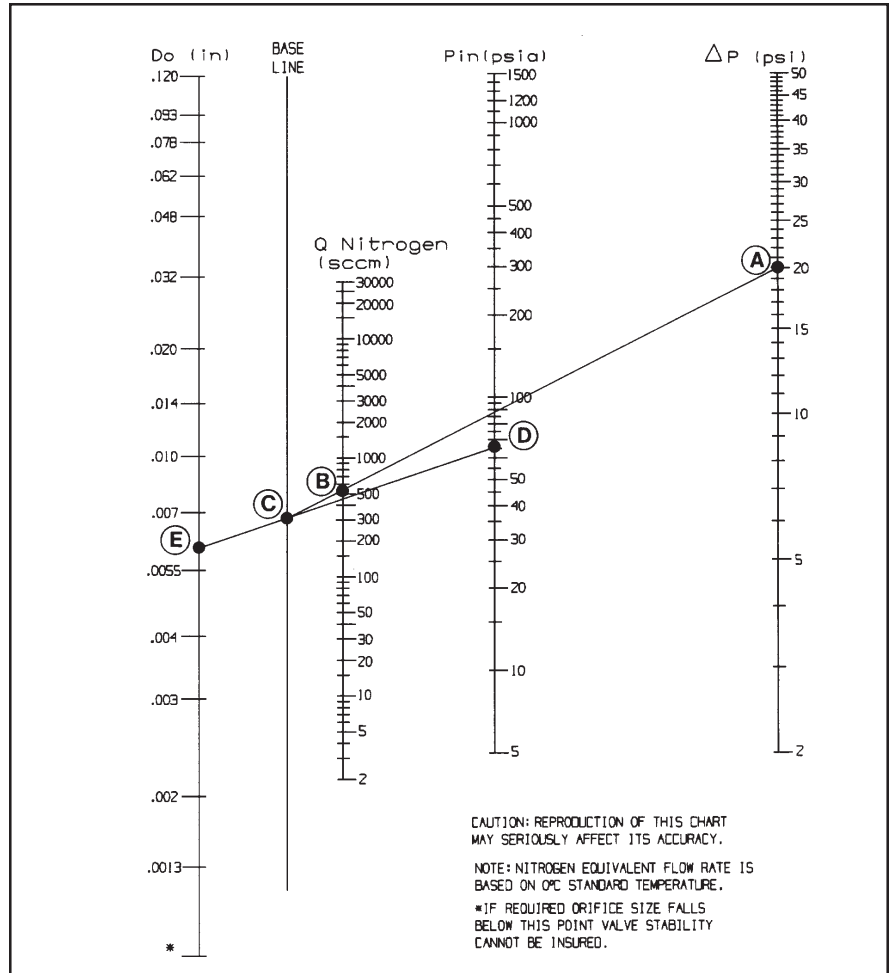

Figure 4-2 Example Nomograph



## 4-5 Restrictor Sizing

The restrictor assembly is a ranging device for the sensor portion of the controller. It creates a pressure drop which is linear with flow rate. This diverts a sample quantity of the process gas flow through the sensor. Each restrictor maintains the ratio of sensor flow to restrictor flow, however, the total flow through each restrictor is different. Different restrictors (active area) have different pressure drops and produce controllers with different full scale flow rates. For a discussion of the interaction of the various parts of the controller, you are urged to review Section 3-3, Theory of Operation. If the restrictor assembly has been contaminated with foreign matter, the pressure drop versus flow characteristics will be altered and it must be cleaned or replaced. It may also be necessary to replace the restrictor assembly when the mass flow controller is to be calibrated to a new flow rate.

Restrictor assembly replacement should be performed only by trained personnel. See Section 4-3, Disassembly and Assembly, for restrictor removal and installation.

### Restrictors

The Model 5964/5850EM mass flow controller/device uses two types of restrictor assemblies depending on full scale flowrate and expected service conditions.

1. Wire mesh for Nitrogen equivalent flow rates above 3.4 slpm. These restrictor assemblies are made from a cylinder of wire mesh and are easily cleaned if they become contaminated in service.
2. Anti-Clog Laminar Flow Element (A.C.L.F.E.) - This type of restrictor assembly is used for Nitrogen equivalent flow rates less than 3.4 slpm.

### Sizing

All Model 5964/5850EM Series Restrictor Assemblies are factory adjusted to provide a specific pressure drop for each flow rate. This corresponds to the desired full scale flow rate. A list of restrictor assemblies used in the Model 5850EM mass flow controller/device is shown in Table 4-4.

Example:

The desired gas is Silane (SiH<sub>4</sub>).

The desired full scale flow rate is 200 sccm.

Sensor conversion factor is 0.625 from Table 4-3.

Nitrogen equivalent flow =  $200/0.625 = 320$  sccm Nitrogen

## Brooks® Models 5964, 5850EM

In the example above a Size P restrictor would be selected.

Note: If the calculated flow rate is such that two different size restrictors could be used, always select the larger size.

If a mixture of two or more gases is being used, the restrictor selection must be based on a Nitrogen equivalent flow rate of the mixture.

Example:

The desired gas is 20% Helium (He) and 80% Chlorine (Cl) by volume. The desired full scale flow rate of the mixture is 20 slpm. Sensor conversion factor for the mixture is:

$$\text{Mixture Factor} = \frac{20}{1.386} + \frac{80}{.876} = .945$$

Nitrogen equivalent flow =  $20/.945 = 21.16$  slpm Nitrogen. In this example a Size 4 Wire Mesh Assembly would be selected.

Table 4-4 Model 5850EM Standard Restrictors

Size	Range SCCM Nitrogen Equivalent Flow*		Part Number	
	Low	High	ACLFE	Wire Mesh
D	8.038	11.38	S110Z275BMG	
E	11.25	15.93	S110Z276BMG	
F	15.75	22.30	S110Z277BMG	
G	22.05	31.23	S110Z278BMG	
H	30.88	43.73	S110Z279BMG	
J	43.23	61.21	S110Z280BMG	
K	60.52	85.70	S110Z281BMG	
L	84.73	119.9	S110Z282BMG	
M	118.6	167.9	S110Z283BMG	
N	166.0	235.2	S110Z284BMG	
P	232.5	329.3	S110Z285BMG	
Q	325.4	460.9	S110Z286BMG	
R	455.7	645.3	S110Z287BMG	
S	638.0	903.4	S110Z288BMG	
T	893.2	1265.	S110Z289BMG	
U	1250.	1771.	S110Z290BMG	
V	1750.	2479.	S110Z291BMG	
W	2451.	3471.	S110Z292BMG	
X	3431.	4859.		S110Z319BMG
Y	4804.	6802.		S110Z321BMG
1	6724.	9523.		S110Z317BMG
2	9388.	13337.		S110Z228BMG
3	13176.	18667.		S110Z226BMG
4	18457.	30060.		S110Z224BMG

\*Materials: BMG = 316 Stainless Steel Electropolished  
CVA = Hastelloy C™ (ACLFE only)  
DCA = Monel R™ (ACLFE only)

- NOTES:**
- For flow rates less than 8 sccm, use the low flow plug, P/N 618-K-019-BMG in place of a restrictor assembly.
  - If two sizes are allowed because of overlap, select the larger size.
  - Restrictor size not required to enter order.

### Dansk

Brooks Instrument  
407 West Vine St.  
Hatfield, PA 19440  
U.S.A.

**Emne** : **Tillæg til instruktions manual.**  
**Reference** : **CE mærkning af Masse Flow udstyr**  
**Dato** : **Januar-1996.**

Brooks Instrument har gennemført CE mærkning af elektronisk udstyr med succes, i henhold til regulativet om elektrisk støj (EMC direktivet 89/336/EEC).

Der skal dog gøres opmærksom på benyttelsen af signalkabler i forbindelse med CE mærkede udstyr.

#### **Kvaliteten af signal kabler og stik:**

Brooks lever kabler af høj kvalitet, der imødekommer specifikationerne til CE mærkning.

Hvis der anvendes andre kabel typer skal der benyttes et skærmet kabel med hel skærm med 100% dækning.

Forbindelses stikket type "D" eller "cirkulære", skal være skærmet med metalhus og eventuelle PG-forskrutninger skal enten være af metal eller metal skærmet.

Skærmen skal forbindes, i begge ender, til stikkets metalhus eller PG-forskrutningen og have forbindelse over 360 grader.

Skærmen bør være forbundet til jord.

"Card Edge" stik er standard ikke af metal, der skal derfor ligeledes benyttes et skærmet kabel med hel skærm med 100% dækning.

Skærmen bør være forbundet til jord.

Forbindelse af stikket; venligst referer til vedlagte instruktions manual.

Med venlig hilsen,

---

### Deutsch

Brooks Instrument  
407 West Vine St.  
Hatfield, PA 19440  
U.S.A.

**Subject** : **Nachtrag zur Bedienungsanleitung.**  
**Referenz** : **CE Zertifizierung für Massedurchflußgeräte**  
**Datum** : **Januar-1996.**

Nach erfolgreichen Tests entsprechend den Vorschriften der Elektromagnetischen Verträglichkeit (EMC Richtlinie 89/336/EEC) erhalten die Brooks-Geräte (elektrische/elektronische Komponenten) das CE-Zeichen.

Bei der Auswahl der Verbindungskabel für CE-zertifizierte Geräte sind spezielle Anforderungen zu beachten.

#### **Qualität der Verbindungskabel, Anschlußstecker und der Kabeldurchführungen**

Die hochwertigen Qualitätskabel von Brooks entsprechen der Spezifikation der CE-Zertifizierung.

Bei Verwendung eigener Verbindungskabel sollten Sie darauf achten, daß eine

100 %igen Schirmabdeckung des Kabels gewährleistet ist.

"D" oder "Rund" -Verbindungsstecker sollten eine Abschirmung aus Metall besitzen.

Wenn möglich, sollten Kabeldurchführungen mit Anschlußmöglichkeiten für die Kabelabschirmung verwendet werden.

Die Abschirmung des Kabels ist auf beiden Seiten des Steckers oder der Kabeldurchführungen über den vollen Umfang von 360 ° anzuschließen.

Die Abschirmung ist mit dem Erdpotential zu verbinden.

Platinen-Steckverbindungen sind standardmäßige keine metallgeschirmten Verbindungen. Um die Anforderungen der CE-Zertifizierung zu erfüllen, sind Kabel mit einer 100 %igen Schirmabdeckung zu verwenden.

Die Abschirmung ist mit dem Erdpotential zu verbinden.

Die Belegung der Anschlußpins können Sie dem beigelegten Bedienungshandbuch entnehmen.

**Brooks® Models 5964, 5850EM**

---

**English**

Brooks Instrument  
407 West Vine St.  
Hatfield, PA 19440  
U.S.A.

**Subject** : **Addendum to the Instruction Manual.**  
**Reference** : **CE certification of Mass Flow Equipment**  
**Date** : **January-1996.**

The Brooks (electric/electronic) equipment bearing the CE mark has been successfully tested to the regulations of the Electro Magnetic Compatibility (EMC directive 89/336/EEC).

Special attention however is required when selecting the signal cable to be used with CE marked equipment.

**Quality of the signal cable, cable glands and connectors:**

Brooks supplies high quality cable(s) which meets the specifications for CE certification.

If you provide your own signal cable you should use a cable which is overall completely screened with a 100% shield.

"D" or "Circular" type connectors used should be shielded with a metal shield. If applicable, metal cable glands must be used providing cable screen clamping.

The cable screen should be connected to the metal shell or gland and shielded at both ends over 360 Degrees.

The shield should be terminated to a earth ground.

Card Edge Connectors are standard non-metallic. The cables used must be screened with 100% shield to comply with CE certification.

The shield should be terminated to a earth ground.

For pin configuration : Please refer to the enclosed Instruction Manual.

---

**Español**

Brooks Instrument  
407 West Vine St.  
Hatfield, PA 19440  
U.S.A.

**Asunto** : **Addendum al Manual de Instrucciones.**  
**Referencia** : **Certificación CE de los Equipos de Caudal Másico**  
**Fecha** : **Enero-1996.**

Los equipos de Brooks (eléctricos/electrónicos) en relación con la marca CE han pasado satisfactoriamente las pruebas referentes a las regulaciones de Compatibilidad Electro magnética (EMC directiva 89/336/EEC).

Sin embargo se requiere una atención especial en el momento de seleccionar el cable de señal cuando se va a utilizar un equipo con marca CE

**Calidad del cable de señal, prensaestopas y conectores:**

Brooks suministra cable(s) de alta calidad, que cumple las especificaciones de la certificación CE .

Si usted adquiere su propio cable de señal, debería usar un cable que esté completamente protegido en su conjunto con un apantallamiento del 100%.

Cuando utilice conectores del tipo "D" ó "Circular" deberían estar protegidos con una pantalla metálica. Cuando sea posible, se deberán utilizar prensaestopas metálicos provistos de abrazadera para la pantalla del cable.

La pantalla del cable deberá ser conectada al casquillo metálico ó prensa y protegida en ambos extremos completamente en los 360 Grados.

La pantalla deberá conectarse a tierra.

Los conectores estandar de tipo tarjeta (Card Edge) no son metálicos, los cables utilizados deberán ser protegidos con un apantallamiento del 100% para cumplir con la certificación CE.

La pantalla deberá conectarse a tierra.

Para ver la configuración de los pines: Por favor, consultar Manual de Instrucciones adjunto.

### Français

Brooks Instrument  
407 West Vine St.  
Hatfield, PA 19440  
U.S.A.

**Sujet** : Annexe au Manuel d'Instructions.  
**Référence** : Certification CE des Débitmètres Massiques à Effet Thermique.  
**Date** : Janvier 1996.

Messieurs,

Les équipements Brooks (électriques/électroniques) portant le label CE ont été testés avec succès selon les règles de la Compatibilité Electromagnétique (directive CEM 89/336/EEC).

Cependant, la plus grande attention doit être apportée en ce qui concerne la sélection du câble utilisé pour véhiculer le signal d'un appareil portant le label CE.

#### **Qualité du câble, des presse-étoupes et des connecteurs:**

Brooks fournit des câbles de haute qualité répondant aux spécifications de la certification CE.

Si vous approvisionnez vous-même ce câble, vous devez utiliser un câble blindé à 100 %.

Les connecteurs « D » ou de type « circulaire » doivent être reliés à la terre.

Si des presse-étoupes sont nécessaires, ceux ci doivent être métalliques avec mise à la terre.

Le blindage doit être raccordé aux connecteurs métalliques ou aux presse-étoupes sur le pourtour complet du câble, et à chacune de ses extrémités.

Tous les blindages doivent être reliés à la terre.

Les connecteurs de type « card edge » sont non métalliques. Les câbles utilisés doivent être blindés à 100% pour satisfaire à la réglementation CE.

Tous les blindages doivent être reliés à la terre.

Se référer au manuel d'instruction pour le raccordement des contacts.

### Greek

Brooks Instrument  
407 West Vine St.  
Hatfield, PA 19440  
U.S.A.

**Θέμα** : Προσθήκη στο Εγχειρίδιο Οδηγιών.  
**Σχετικά** : Πιστοποίηση CE των Οργάνων Μέτρησης Παροχής Μάζας.  
**Ημερομηνία** : Ιανουάριος - 1996

Κυρίες και Κύριοι,

Τα όργανα (ηλεκτρικά/ηλεκτρονικά) της Brooks τα οποία φέρουν το σήμα CE έχουν επιτυχώς ελεγχθεί σύμφωνα με τους κανονισμούς της Ηλεκτρο-Μαγνητικής Συμβατότητας (EMC ντιρεκτίβα 89/336/EEC).

Οποσδήποτε χρειάζεται ειδική προσοχή κατά την επιλογή του καλωδίου μεταφοράς του σήματος το οποίο (καλώδιο) πρόκειται να χρησιμοποιηθεί με όργανα που φέρουν το σήμα CE.

#### **Ποιότητα του καλωδίου σήματος των στυπιοθλιπτών και των συνδέσμων .**

Η Brooks κατά κανόνα προμηθεύει υψηλής ποιότητας καλώδια τα οποία πληρούν τις προδιαγραφές για πιστοποίηση CE.

Εάν η επιλογή του καλωδίου σήματος γίνει από σας πρέπει να χρησιμοποιήσετε καλώδιο το οποίο να φέρει εξωτερικά πλήρες πλέγμα και να παρέχει θωράκιση 100%.

Οι σύνδεσμοι τύπου "D" ή "Κυκλικοί" των καλωδίων, πρέπει να θωρακίζονται με μεταλλική θωράκιση. Εάν είναι εφαρμόσιμο, πρέπει να χρησιμοποιούνται μεταλλικοί στυπιοθλιπτες καλωδίων που να διαθέτουν ακροδέκτη σύνδεσης του πλέγματος του καλωδίου.

Το πλέγμα του καλωδίου πρέπει να συνδέεται στο μεταλλικό περιβλήμα ή στον στυπιοθλιπτή και να θωρακίζεται και στα δύο άκρα κατά 360 μοίρες.

Η θωράκιση πρέπει να καταλήγει σε κάποιο ακροδέκτη γείωσης.

Οι σύνδεσμοι καρτών είναι μη-μεταλλικοί, τα καλώδια που χρησιμοποιούνται πρέπει να φέρουν πλέγμα θωράκισης 100% για να υπακούουν στην πιστοποίηση CE.

Η θωράκιση πρέπει να καταλήγει σε κάποιο ακροδέκτη γείωσης.

Για την διάταξη των ακροδεκτών: Παρακαλούμε αναφερθείτε στο εσώκλειστο Εγχειρίδιο Οδηγιών.

**Brooks® Models 5964, 5850EM**

---

**Italiano**

Brooks Instrument  
407 West Vine St.  
Hatfield, PA 19440  
U.S.A.

**Oggetto** : **Addendum al manuale di istruzioni.**  
**Riferimento** : **Certificazione CE dei misuratori termici di portata in massa**  
**Data** : **Gennaio 1996.**

Questa strumentazione (elettrica ed elettronica) prodotta da Brooks Instrument, soggetta a marcatura CE, ha superato con successo le prove richieste dalla direttiva per la Compatibilità Elettromagnetica (Direttiva EMC 89/336/EEC).

E' richiesta comunque una speciale attenzione nella scelta dei cavi di segnale da usarsi con la strumentazione soggetta a marchio CE.

**Qualità dei cavi di segnale e dei relativi connettori:**

Brooks fornisce cavi di elevata qualità che soddisfano le specifiche richieste dalla certificazione CE. Se l'utente intende usare propri cavi, questi devono possedere una schermatura del 100%.

I connettori sia di tipo "D" che circolari devono possedere un guscio metallico. Se esiste un passacavo esso deve essere metallico e fornito di fissaggio per lo schermo del cavo.

Lo schermo del cavo deve essere collegato al guscio metallico in modo da schermarlo a 360° e questo vale per entrambe le estremità.

Lo schermo deve essere collegato ad un terminale di terra.

I connettori "Card Edge" sono normalmente non metallici. Il cavo impiegato deve comunque avere una schermatura del 100% per soddisfare la certificazione CE.

Lo schermo deve essere collegato ad un terminale di terra.

Per il corretto cablaggio dei terminali occorre fare riferimento agli schemi del manuale di istruzioni dello strumento.

---

**Nederlands**

Brooks Instrument  
407 West Vine St.  
Hatfield, PA 19440  
U.S.A.

**Onderwerp** : **Addendum voor Instructie Handboek**  
**Referentie:** **CE certificering voor Mass Flow Meters & Controllers**  
**Datum** : **Januari 1996**

Dames en heren,

Alle CE gemarkeerde elektrische en elektronische producten van Brooks Instrument zijn met succes getest en voldoen aan de wetgeving voor Electro Magnetische Compatibiliteit (EMC wetgeving volgens 89/336/EEC).

Speciale aandacht is echter vereist wanneer de signaalkabel gekozen wordt voor gebruik met CE gemarkeerde producten.

**Kwaliteit van de signaalkabel en kabelansluitingen:**

- Brooks levert standaard kabels met een hoge kwaliteit, welke voldoen aan de specificaties voor CE certificering. Indien men voorziet in een eigen signaalkabel, moet er gebruik gemaakt worden van een kabel die volledig is afgeschermd met een bedekkingsgraad van 100%.
- "D" of "ronde" kabelconnectoren moeten afgeschermd zijn met een metalen connector kap. Indien kabelwartels worden toegepast, moeten metalen kabelwartels worden gebruikt die het mogelijk maken het kabelscherm in te klemmen. Het kabelscherm moet aan beide zijden over 360° met de metalen connectorkap, of wartel verbonden worden. Het scherm moet worden verbonden met aarde.
- "Card-edge" connectors zijn standaard niet-metallisch. De gebruikte kabels moeten volledig afgeschermd zijn met een bedekkingsgraad van 100% om te voldoen aan de CE certificering. Het scherm moet worden verbonden met aarde.

Voor pin-configuraties a.u.b. verwijzen wij naar het bijgesloten instructie handboek.

Hoogachtend,

### Norsk

Brooks Instrument  
407 West Vine St.  
Hatfield, PA 19440  
U.S.A.

**Vedrørende** : Vedlegg til håndbok  
**Referanse** : CE sertifisering av utstyr for massestrømsmåling og regulering  
**Dato** : Januar 1996

### Til den det angår

Brooks Instrument elektrisk og elektronisk utstyr påført CE-merket har gjennomgått og bestått prøver som beskrevet i EMC forskrift om elektromagnetisk immunitet, direktiv 89/336/EEC.

For å opprettholde denne klassifisering er det av stor viktighet at riktig kabel velges for tilkobling av det måletekniske utstyret.

### Utførelse av signalkabel og tilhørende plugger:

- Brooks Instrument tilbyr levert med utstyret egnet kabel som møter de krav som stilles til CE-sertifisering.
- Dersom kunden selv velger kabel, må kabel med fullstendig, 100% skjerming av lederene benyttes. "D" type og runde plugger og forbindelser må være utført med kappe i metall og kabelnipler må være utført i metall for jordat innfesting av skjermen. Skjermen i kablen må tilknyttes metallet i pluggen eller nippelen i begge ender over 360°, tilkoblet elektrisk jord.
- Kort-kantkontakter er normalt utført i kunststoff. De tilhørende flatkabler må være utført med fullstendig, 100% skjerming som kobles til elektrisk jord på riktig pinne i pluggen, for å møte CE sertifiseringskrav.

For tilkobling av medleverte plugger, vennligst se håndboken som hører til utstyret.

Vennlig hilsen

---

### Português

Brooks Instrument  
407 West Vine St.  
Hatfield, PA 19440  
U.S.A.

**Assunto** : Adenda ao Manual de Instruções  
**Referência** : Certificação CE do Equipamento de Fluxo de Massa  
**Data** : Janeiro de 1996.

O equipamento (eléctrico/electrónico) Brooks com a marca CE foi testado com êxito nos termos do regulamento da Compatibilidade Electromagnética (directiva CEM 89/336/EEC).

Todavia, ao seleccionar-se o cabo de sinal a utilizar com equipamento contendo a marca CE, será necessário ter uma atenção especial.

### Qualidade do cabo de sinal, buchas de cabo e conectores:

A Brooks fornece cabo(s) de qualidade superior que cumprem os requisitos da certificação CE.

Se fornecerem o vosso próprio cabo de sinal, devem utilizar um cabo que, na sua totalidade, seja isolado com uma blindagem de 100%.

Os conectores tipo "D" ou "Circulares" devem ser blindados com uma blindagem metálica. Se tal for necessário, deve utilizar-se buchas metálicas de cabo para o isolamento do aperto do cabo.

O isolamento do cabo deve ser ligado à blindagem ou bucha metálica em ambas as extremidades em 360°.

A blindagem deve terminar com a ligação à massa.

Os conectores "Card Edge" não são, em geral, metálicos e os cabos utilizados devem ter um isolamento com blindagem a 100% nos termos da Certificação CE..

A blindagem deve terminar com ligação à massa.

Relativamente à configuração da cavilha, queiram consultar o Manual de Instruções.

**Brooks® Models 5964, 5850EM**

---

**Suomi**

Brooks Instrument  
407 West Vine St.  
Hatfield, PA 19440  
U.S.A.

**Asia : Lisäys Käyttöohjeisiin**

**Viite : Massamäärämittareiden CE sertifiointi**

**Päivämäärä : Tammikuu 1996**

Brooksin CE merkillä varustetut sähköiset laitteet ovat läpäissyt EMC testit (direktiivi 89/336/EEC).

Erityistä huomiota on kuitenkin kiinnitettävä signaalikaapelin valintaan.

**Signaalikaapelin, kaapelin läpiviennin ja liittimen laatu**

Brooks toimittaa korkealaatuisia kaapeleita, jotka täyttävät CE sertifikaatin vaatimukset. Hankkiessaan signaalikaapelin itse, olisi hankittava 100%:sti suojattu kaapeli.

“D” tai “Circular” tyyppisen liittimen tulisi olla varustettu metallisuojaalla. Mikäli mahdollista, tulisi käyttää metallisia kaapeliliittimiä kiinnitettäessä suoja.

Kaapelin suoja tulisi olla liitetty metallisuojaan tai liittimeen molemmissa päissä 360°:n matkalta.

Suojan tulisi olla maadoitettu.

“Card Edge Connector”it ovat standarditoimituksina ei-metallisia. Kaapeleiden täytyy olla 100%:sesti suojattuja jotta ne olisivat CE sertifikaatin mukaisia.

Suoja on oltava maadoitettu.

Nastojen liittäminen; katso liitteenä oleva manuaali.

Ystävällisin terveisin,

---

**Svensk**

Brooks Instrument  
407 West Vine St.  
Hatfield, PA 19440  
U.S.A.

**Subject : Addendum to the Instruction Manual**

**Reference : CE certification of Mass Flow Equipment**

**Date : January 1996**

Brooks (elektriska / elektronik) utrustning, som är CE-märkt, har testats och godkänts enligt gällande regler för elektromagnetisk kompatibilitet (EMC direktiv 89/336/EEC).

Speciell hänsyn måste emellertid tas vid val av signalkabel som ska användas tillsammans med CE-märkt utrustning.

**Kvalitet på signalkabel och anslutningskontakter:**

Brooks levererar som standard, kablar av hög kvalitet som motsvarar de krav som ställs för CE-godkännande.

Om man använder en annan signalkabel ska kabeln i sin helhet vara skärmad till 100%.

“D” eller “runda” typer av anslutningskontakter ska vara skärmade. Kabelgenomföringar ska vara av metall alternativt med metalliserad skärmning.

Kabelns skärm ska, i bada ändrar, vara ansluten till kontakternas metallkåpor eller genomföringar med 360 graders skärmning.

Skärmen ska avslutas med en jordförbindelse.

Kortkontakter är som standard ej metalliserade, kablar som används måste vara 100% skärmade för att överensstämma med CE-certifieringen.

Skärmen ska avslutas med en jordförbindelse.

För elektrisk anslutning till kontaktstiften hänvisas till medföljande instruktionsmanual.



# Installation and Operation Manual

X-TMF-5964-5850EM-MFC-eng

Part Number: 541B121AHG

November, 2008

Brooks® Models 5964, 5850EM

---

*THIS PAGE WAS  
INTENTIONALLY  
LEFT BLANK*

Brooks® Models 5964, 5850EM

LIMITED WARRANTY

Seller warrants that the Goods manufactured by Seller will be free from defects in materials or workmanship under normal use and service and that the Software will execute the programming instructions provided by Seller until the expiration of the earlier of twelve (12) months from the date of initial installation or eighteen (18) months from the date of shipment by Seller. Products purchased by Seller from a third party for resale to Buyer ("Resale Products") shall carry only the warranty extended by the original manufacturer.

All replacements or repairs necessitated by inadequate preventive maintenance, or by normal wear and usage, or by fault of Buyer, or by unsuitable power sources or by attack or deterioration under unsuitable environmental conditions, or by abuse, accident, alteration, misuse, improper installation, modification, repair, storage or handling, or any other cause not the fault of Seller are not covered by this limited warranty, and shall be at Buyer's expense.

Goods repaired and parts replaced during the warranty period shall be in warranty for the remainder of the original warranty period or ninety (90) days, whichever is longer. This limited warranty is the only warranty made by Seller and can be amended only in a writing signed by an authorized representative of Seller.

BROOKS SERVICE AND SUPPORT

Brooks is committed to assuring all of our customers receive the ideal flow solution for their application, along with outstanding service and support to back it up. We operate first class repair facilities located around the world to provide rapid response and support. Each location utilizes primary standard calibration equipment to ensure accuracy and reliability for repairs and recalibration. The primary standard calibration equipment to calibrate our flow products is certified by our local Weights and Measures Authorities and traceable to the relevant International Standards.

Visit www.BrooksInstrument.com to locate the service location nearest to you.

START-UP SERVICE AND IN-SITU CALIBRATION

Brooks Instrument can provide start-up service prior to operation when required.

For some process applications, where ISO-9001 Quality Certification is important, it is mandatory to verify and/or (re)calibrate the products periodically. In many cases this service can be provided under in-situ conditions, and the results will be traceable to the relevant international quality standards.

CUSTOMER SEMINARS AND TRAINING

Brooks Instrument can provide customer seminars and dedicated training to engineers, end users and maintenance persons. Please contact your nearest sales representative for more details.

HELP DESK

In case you need technical assistance:

- Americas 1-888-554-FLOW
Europe +(31) 318 549 290 Within Netherlands 0318 549 290
Asia +011-81-3-5633-7100

Due to Brooks Instrument's commitment to continuous improvement of our products, all specifications are subject to change without notice.

TRADEMARKS

- Brooks Brooks Instrument, LLC
Freon E.I. DuPont de Nemours & Co.
Kalrez DuPont Dow Elastomers
Teflon E.I. DuPont de Nemours & Co.
VCO Cajon Co.
VCR Cajon Co.
Viton DuPont Performance Elastomers
Vol-U-Meter Brooks Instrument, LLC



Brooks Instrument
407 West Vine Street
P.O. Box 903
Hatfield, PA 19440-0903 USA
T (215) 362-3700
F (215) 362-3745
E-Mail BrooksAm@BrooksInstrument.com
www.BrooksInstrument.com

Brooks Instrument
Neonstraat 3
6718 WX Ede, Netherlands
T 31-318-549-300
F 31-318-549-309
E-Mail BrooksEu@BrooksInstrument.com

Brooks Instrument
1-4-4 Kitasuna Koto-Ku
Tokyo, 136-0073 Japan
T 011-81-3-5633-7100
F 011-81-3-5633-7101
E-Mail BrooksAs@BrooksInstrument.com

