

Flashing Beacon and Continuous Beacon Series 6161



- > Robust, seawater resistant aluminium enclosure
- > Flashing frequency 1 Hz
- > Flashing energy 5 Joules
- > Integrated Ex e connection chamber
- > Light dome available in: signal yellow, red, orange, green, blue and clear
- > Steady beacon in LED technology
- > Extreme temperature range -40 ... +50 °C

www.stahl.de



01817E00



The flashing beacons and steady beacons of Series 6161 are installed to provide optical signals in explosive gas atmospheres and areas with combustible dust.

	ATEX / IECEx					
Zone	0	1	2	20	21	22
For use in		x	x		x	x



WebCode 6161A

Flashing Beacon and Continuous Beacon

Series 6161



Selection Table

Version	Rated operational voltage	Order number	Weight kg
 09344E00 6161/2 Flashing Beacon	230 V AC, 50 ... 60 Hz	6161/2-11-.21-0	1.500
	110 ... 127 V AC, 50 ... 60 Hz	6161/2-31-.21-0	1.500
	24 ... 42 V AC, 50 ... 60 Hz and 12 ... 48 V DC	6161/2-61-.21-0	1.500
	60 ... 80 V DC	6161/2-41-.21-0	1.500
 09344E00 6161/3 Continuous Beacon	230 V AC, 50 ... 60 Hz	6161/3-10-.21-0	1.400
	24 V AC / DC, 0 Hz, 50 ... 60 Hz	6161/3-70-.21-0	1.400

Order Number Supplement

Colour of glass	signal yellow	6161 / - 1 . .
	clear	6161 / - 2 . .
	red	6161 / - 3 . .
	blue	6161 / - 4 . .
	green	6161 / - 5 . .
	orange	6161 / - 6 . .

Note The optical beacons are supplied without attachment materials and wire guard. These must be ordered separately!

Explosion Protection

Global (IECEX)

Gas and dust IECEx LCI 08.0032X
 Ex d e IIC T* Gb -40°C T_{amb} +**°C
 Ex tb IIIC T* Db IP66 -40°C T_{amb} +**°C
 IEC 60079-0 : 2011
 IEC 60079-1 : 2007-04
 IEC 60079-7 : 2006-07
 IEC 60079-31 : 2008
 ** see ambient conditions for the temperature class

Europe (ATEX)

Gas and dust LCIE 02 ATEX 6062 X
 Ⓢ II 2 G Ex d e IIC T* Gb -40°C T_{amb} +**°C
 Ⓢ II 2 D Ex tb IIIC T* Db IP66 -40°C T_{amb} +**°C
 EN 60079-0 : 2012
 EN 60079-1 : 2007
 EN 60079-7 : 2007
 EN 60079-31 : 2009
Conditions of certificate:
 If wire guard is not installed, the apparatus shall be submitted to low mechanical impact only.
 ** see ambient conditions for the temperature class

Certifications and certificates

Version	6161/2 Flashing Beacon	6161/3 Continuous Beacon
Certificates	IECEX, ATEX, India (PESO), China (China-EX), Kazakhstan (TR), Korea (KGS), Russia (TR), Belarus (TR)	IECEX, ATEX, India (PESO), China (China-EX), Kazakhstan (TR), Korea (KGS), Russia (TR), Belarus (TR)
Ship approval	GL	--
Conformity	CE 0158 according to 94/9/CE	CE 0158 according to 94/9/CE

E5

Flashing Beacon and Continuous Beacon

Series 6161



Technical Data

Electrical data

Version	6161/2 Flashing Beacon	6161/3 Continuous Beacon
Rated values	24 ... 42 V AC 50 ... 60 Hz 0.5 ... 0.3 A 110 ... 127 V AC 50 ... 60 Hz 0.11 A 230 V AC 50 ... 60 Hz 0.08 A	24 V AC / DC 0 Hz, 50 ... 60 Hz 0.12 A 230 V AC 50 ... 60 Hz 0.02 A
	12 ... 48 V DC 0.5 ... 0.3 A 60 ... 80 V DC 0.13 ... 0.11 A	
Back-up fuse	4 AT (Fuse slow-blow or automatic circuit breaker C characteristic)	

Luminous characteristics

Version	6161/2 Flashing Beacon	6161/3 Continuous Beacon
Flashing energy	5 Joules	--
Flashing frequency	1 Hz	--
Duty cycle	100%	100%
Service life	6 x 10 ⁶ flashes	--

Ambient conditions

Ambient temperature	** Temperature Class				** Temperature Class			
	Type	T _{amb}	Gas	Dust	Type	T _{amb}	Gas	Dust
	6121/2	+40 °C	T6	T85 °C	6121/3	+40 °C	T6	T65 °C
		+50 °C	T5	T100 °C		+50 °C	T6	T75 °C



Mechanical data

Degree of protection	IP66 according to IEC/EN 60529
Protection class	I (internal and external PE connection terminal according to IEC/EN 60598)
Material	
Enclosure	aluminium alloy copper-free, yellow/black powder-coated
Light dome	polycarbonate, prismatic
Wire guard	stainless steel
Fixing elements	stainless steel
Sealing ring	NBR-O-ring seal
Special lock	Ex d enclosure; M4 hexagon socket stud

Mounting / Installation

Cable entries	1 x M20 x 1.5 stopping plug 1 x M20 x 1.5 cable gland metal cable gland on request
Clamping range	4 ... 13 mm
Connection type	screw terminal block, 3-pole
Marking	L1 + N + PE
Connection cross-section	
solid	2 x 4 mm ²
finely stranded	2 x 2.5 mm ²
Protective conductor connection	
Inside	max. 6 mm ²
Outside	max. 2.5 mm ² flexible / 4 mm ² rigid



Accessories and Spare Parts

Designation	Figure	Description	Art. no.	Weight kg	
Mounting plate	 04279E00	material: stainless steel, includes mounting screws, for wall or floor mounting	120821	0.170	
Pipe clamp	 09349E00		R 1 1/4 "	120812	0.500
			R 1 1/2 "	120819	0.470
			R 2 "	120823	0.500

Flashing Beacon and Continuous Beacon Series 6161

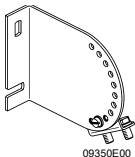
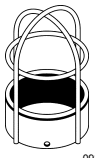

Accessories and Spare Parts

Designation	Figure	Description	Art. no.	Weight kg	
Ceiling or wall-mounting bracket		material: stainless steel includes mounting screws	120826	0.480	
Wire guard		material: stainless steel	120818	0.260	
Cable gland		8161/7-M20-1304 4 ... 13 mm ²	50 pieces (delivery lot ^{*)}	239156	0.012
Stopping plug		8290/3-M20	1 piece	143522	0.005
		8290/3-M20	100 pieces	143543	0.500

^{*)} Purchase order quantity in [pieces], the delivery quantity is automatically rounded to the delivery lot.

E5

Dimensional Drawings (All Dimensions in mm) - Subject to Alterations

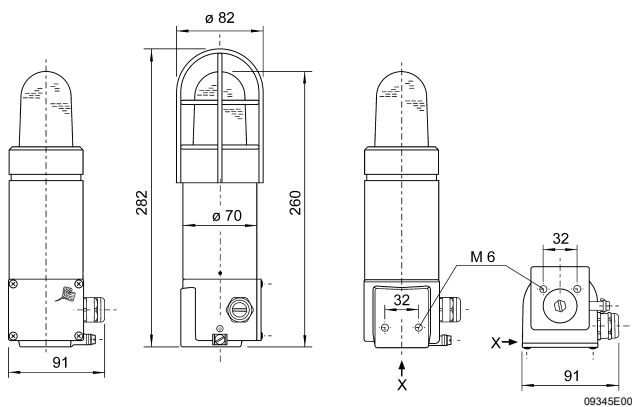

Optical beacon 6161

Mounting accessories

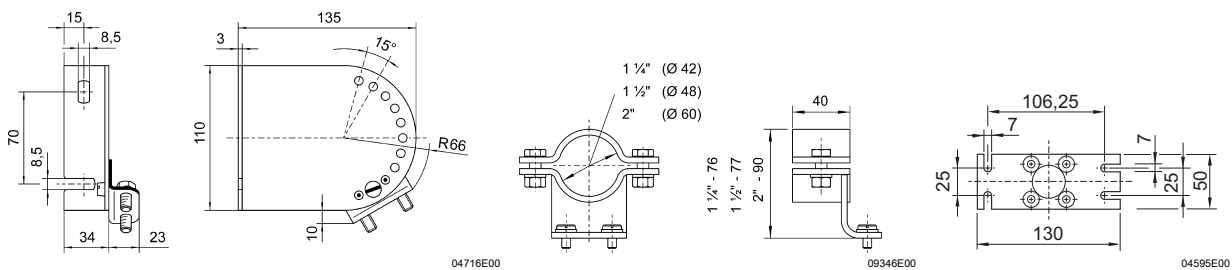

Ceiling and wall-mounting bracket

Pipe clamp

Mounting plate

We reserve the right to make alterations to the technical data, dimensions, weights, designs and products available without notice. The illustrations cannot be considered binding.