

Submersible pressure sensor For oils and fuels Model LF-1

WIKA data sheet LM 40.04



Applications

- Level measurement in vessel and storage systems for oils and fuels
- Overfilling and dry-run monitoring
- Battery-operated level measuring systems

Special features

- Developed for all common oils and fuels
- Explosion protection selectable in accordance with ATEX or IECEx
- Low-power output signals for battery-operated measuring systems available
- Optional temperature output for density compensation and temperature monitoring

Description

Developed for oils and fuels

The submersible pressure sensor model LF-1 has been developed especially for the level measurement of fuels and oils. Extensive test cycles guarantee a permanent resistance and long service life in all oils and fuels as well as in aggressive crude oils and biofuels.

Thanks to newly developed special cables, components made of high-alloyed stainless steel and an optional overvoltage protection against lightning, the submersible pressure sensor for measurement applications in oils and fuels is also perfectly suited for use in the outdoor area.

Precise level and temperature measurement with HART® communication

A measurement uncertainty of max. 0.5 %, a long-term drift of 0.1 % and slight temperature errors make the LF-1 a reliable measurement solution for the monitoring of storage tanks. The additional analogue temperature output facilitates the compensation of a temperature-induced density error especially at temperatures of up to -40 ... +80 °C.



Submersible pressure sensor with conduit and FEP cable, model LF-1

The integrated HART® communication can be used for scaling the measuring range and for the parameterisation of unit, error signal, and others.

Optimised electronics for battery operation

The modern electronic system guarantees not only a high accuracy in the long term but also ensures a very long battery life thanks to low power supply, low current consumption, fast response time and low-power output signals.

Safety also in hazardous areas

The optional intrinsically safe electronic system is authorised according to the common international standards and allows a safe worldwide application in explosive gases and vapours.

Measuring ranges

Gauge pressure							
bar	0 ... 0.1	0 ... 0.16	0 ... 0.25	0 ... 0.4	0 ... 0.6	0 ... 1	0 ... 1.6
	0 ... 2.5	0 ... 4	0 ... 6				
inWC	0 ... 50	0 ... 100	0 ... 150	0 ... 250			
psi	0 ... 5	0 ... 10	0 ... 15	0 ... 25	0 ... 50	0 ... 100	
mH ₂ O	0 ... 1	0 ... 1.6	0 ... 2.5	0 ... 4	0 ... 6	0 ... 10	0 ... 16
	0 ... 25	0 ... 40	0 ... 60				

Absolute pressure							
bar	0 ... 1.6	0 ... 2.5	0 ... 4	0 ... 6			
psi	0 ... 25	0 ... 50	0 ... 100				

The given measuring ranges are also available in mbar, kPa and MPa.

Overpressure limit

≥ 3 times

Temperature measurement (option)

Measuring ranges	
Option 1	-10 ... +50 °C (14 ... 122 °F)
Option 2	-40 ... +80 °C (-40 ... +176 °F)

The temperature output signal corresponds to the selected medium temperature (see operating conditions).

Output signals

Without temperature measurement	
Standard	4 ... 20 mA (2-wire)
Option 1	4 ... 20 mA + HART® (2-wire)
Option 2	DC 0.1 ... 2.5 V (3-wire, low power) ¹⁾

With temperature measurement	
Standard	2 x 4 ... 20 mA (2 x 2-wire, galvanically isolated)
Option 1	2 x DC 0.1 ... 2.5 V (3-wire, low power) ¹⁾

¹⁾ Shortening the cable always results in a modification of the voltage signal (see accuracy specifications).

Load

Current output: $\leq (U_+ - (U_{+min} - 0.5 \text{ V})) / 0.023 \text{ A}$

Voltage output: $\leq 1 \text{ mA}$

Additional load of the cable:

$\leq \text{cable length in m} \times 0.084 \ \Omega$

$(\leq \text{cable length in ft} \times 0,0256 \ \Omega)$

For voltage outputs, the load must be specified so that the output current does not exceed 1 mA.

Voltage supply

The power supply depends on the selected output signal and the intrinsically safe electronics (Ex approval).
When being operated in hazardous areas, the submersible pressure sensor must be powered via an isolated barrier (see accessories).

Power supply

Output signal	Standard	With Ex approval
4 ... 20 mA (2-wire)	DC 8 ... 36 V	DC 9 ... 30 V
4 ... 20 mA + HART® (2-wire)	DC 12 ... 36 V	DC 12 ... 30 V
DC 0.1 ... 2.5 V (3-wire, low power)	DC 3.6 ... 36 V	-
2 x 4 ... 20 mA (2 x 2-wire, galvanically isolated)	DC 8 ... 36 V	DC 9 ... 30 V
2 x DC 0.1 ... 2.5 V (3-wire, low power)	DC 3.6 ... 36 V	-

Low power is optimised for the battery operation.

Current consumption

Current output: max. 25 mA per output

Voltage output: max. 5 mA

Reference conditions (per IEC 61298-1)

Temperature

15 ... 25 °C (59 ... 77 °F)

Atmospheric pressure

860 ... 1,060 mbar (86 ... 106 kPa /12.5 ... 15.4 psig)

Humidity

45 ... 75 % r. h.

Power supply

- DC 24 V with current output
- DC 5 V with voltage output

Mounting position

Calibrated in vertical mounting position with process connection facing downwards.

Accuracy specifications

Accuracy at reference conditions (pressure sensor)

	Accuracy ¹⁾	Non-linearity (per IEC 61298-2) BFSL
Standard	$\leq \pm 1$ % of span	$\leq \pm 0.5$ % of span
Option	$\leq \pm 0.5$ % of span	$\leq \pm 0.25$ % of span

1) Including non-linearity, hysteresis, zero offset and end value deviation (corresponds to measured error per IEC 61298-2).

During the adjustment of the voltage signals, the cable length will be compensated. Each shortening of the cable at a later stage results in an offset error of approx. 0.14 % / 10 m (0.13 % / 30 ft).

Accuracy after turndown 5:1 via HART®	
Standard	$\leq \pm 1.25$ % of scaled span
Option	$\leq \pm 0.75$ % of scaled span

By setting a turndown of greater than 5:1, a higher measured error applies.

Accuracy (temperature sensor)

-10 ... +80 °C (14 ... 176 °F): $\leq \pm 1,8$ K

-30 ... -10 °C (-22 ... +14 °F): $\leq \pm 3,0$ K

-40 ... -30 °C (-40 ... -22 °F): $\leq \pm 4,5$ K

Non-repeatability

≤ 0.1 % of span

≤ 0.2 % of span (with voltage output and cable length

> 100 m (325 ft))

Long-term stability (per DIN 16086:2006-01)

Measuring range > 0 ... 0.1 bar: $\leq \pm 0.1$ % of span/year

Measuring range ≤ 0 ... 0.1 bar: $\leq \pm 0.2$ % of span/year

Switch-on time

Output signals without HART®: ≤ 150 ms

Output signals with HART®: ≤ 250 ms

Settling time

Output signals without HART®: ≤ 100 ms

Output signals with HART®: ≤ 250 ms

Total error band

Including non-linearity, hysteresis, zero point and span error, temperature error and temperature hysteresis.

■ Measuring range ≥ 0.6 bar, ≥ 250 inWC, ≥ 10 psi, ≥ 6 mH₂O

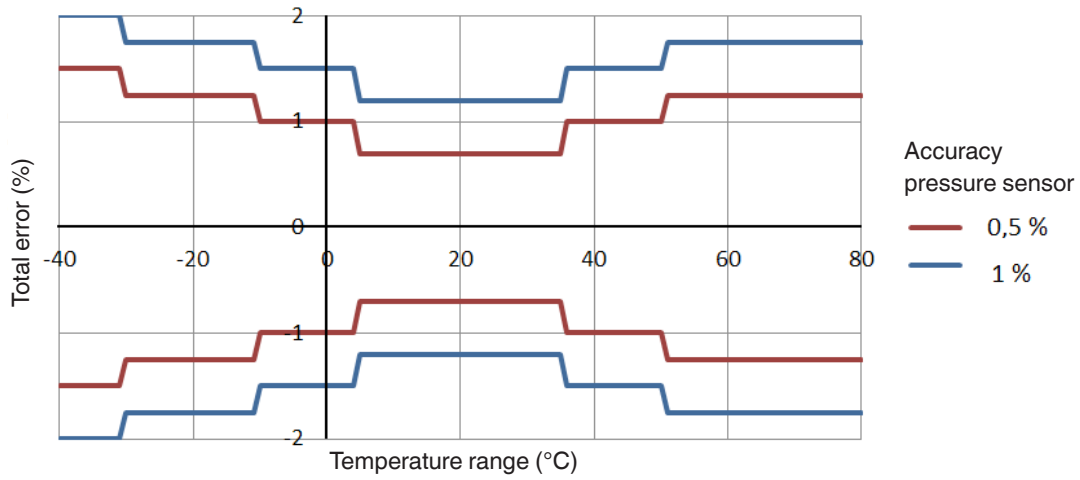

■ Measuring range 0.4 bar, 150 inWC, 4 mH₂O

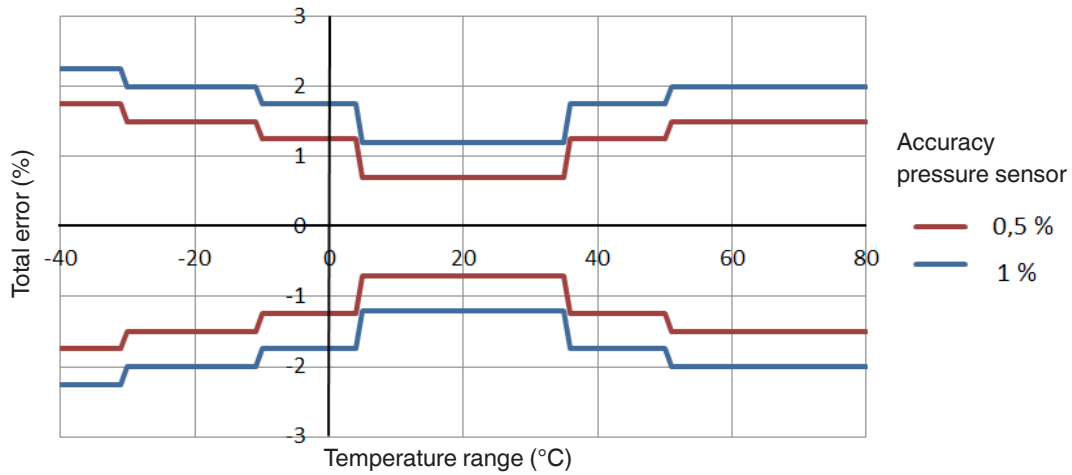

■ Measuring range 0.25 bar, 100 inWC, 5 psi, 2.5 mH₂O

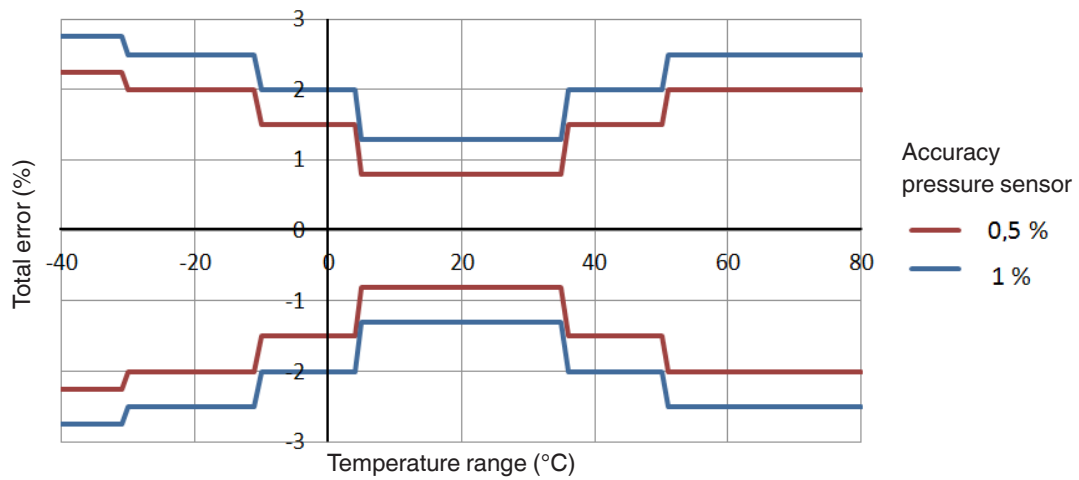

■ Measuring range 0.16 bar, 1.6 mH₂O

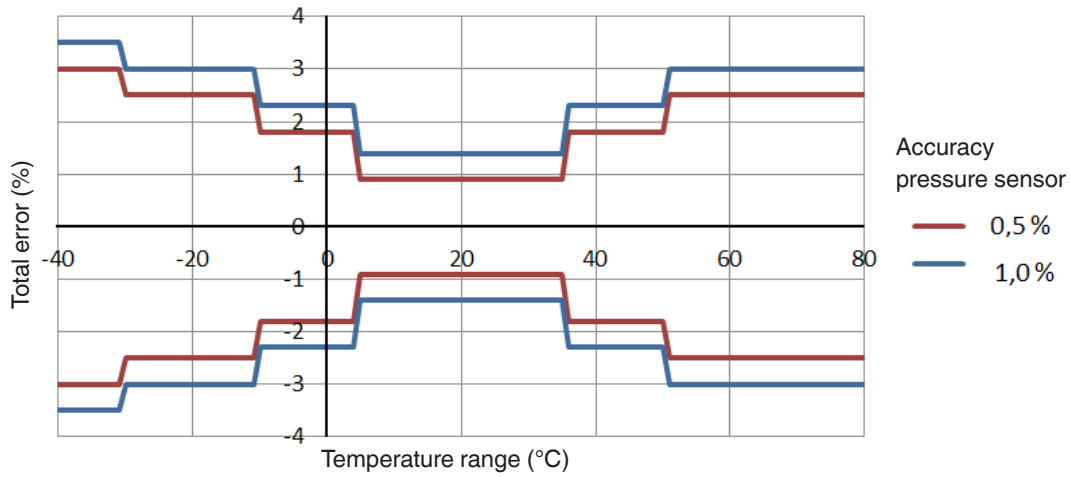

■ Measuring range 0.1 bar, 50 inWC, 1 mH₂O

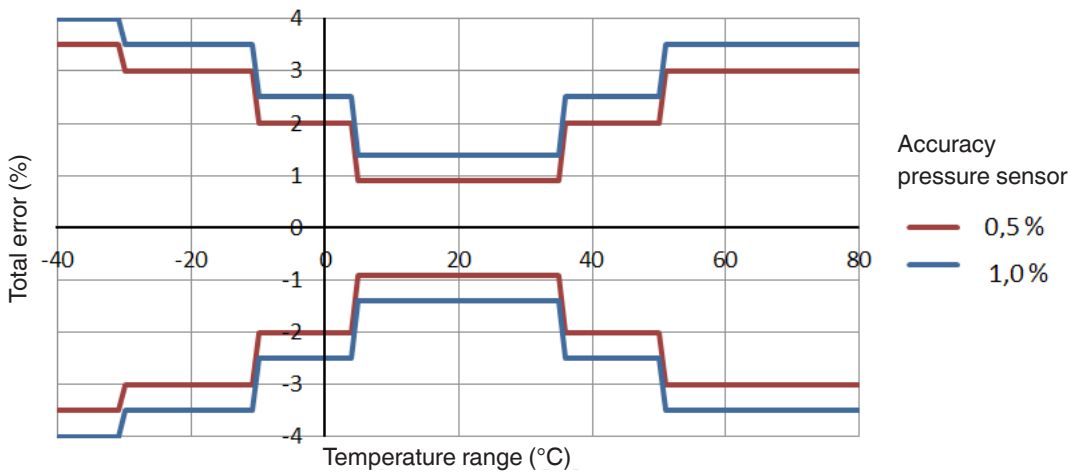

Operating conditions

Ingress protection

IP68

Increased overvoltage protection for lightning strikes (option)

Nominal discharge current: ≥ 10 kA

Rise time: 8/20 μ s

Immersion depth

max. 100 m (325 ft)

Max. tensile force of the cable

1,000 N

Weight

Submersible pressure sensor: approx. 300 g (0.661 lbs)

Cable: approx. 80 g/m (0.538 lbs / 10 ft)

Additional weight: approx. 300 g (0.661 lbs)

Permissible temperature ranges		
Medium	Standard	-10 ... +50 °C (14 ... 122 °F)
	Option	-40 ... +80 °C (-40 ... +176 °F)
Ambient	Standard	-40 ... +80 °C (-40 ... +176 °F)
Storage	Standard	-30 ... +80 °C (-22 ... +176 °F)

Explosion protection (option)

Approval	Marking
ATEX	Zone 0 gas [II 1G Ex ia IIC T4/T5/T6 Ga] Zone 1 gas [II 2G Ex ia IIC T4/T5/T6 Gb]
IECEX	Zone 0 gas [Ex ia IIC T4/T5/T6 Ga] Zone 1 gas [Ex ia IIC T4/T5/T6 Gb]

Permissible ambient temperature ranges in hazardous areas

T4: -40 ... +80 °C (-40 ... +176 °F)

T5: -40 ... +74 °C (-40 ... +165 °F)

T6: -40 ... +59 °C (-40 ... +138 °F)

Materials (wetted)

	Standard	Option (high-resistance)
Case	316L	318LN
Sensor element	316L	Hastelloy C276
Cable	PUR	FEP
Sealing	FKM	FKM
Protection cap	PVDF	PVDF

Electrical connection

Cable outlet	
Standard	Cable outlet without conduit
Option	Cable outlet with conduit

Cable lengths										
Standard	Metre (m)	3	5	10	15	20	25	30	40	50
	Feet (ft)	10	20	30	40	50	75	100	125	150
Option	Metre (m)	For current output, freely definable up to 1,000 m								
		For voltage output, freely definable up to 200 m								
	Feet (ft)	For current output, freely definable up to 3,250 ft								
		For voltage output, freely definable up to 650 ft								

Other lengths on request

Short-circuit resistance

S+ vs. U-

Reverse polarity protection

U+ vs. U-

Resistance to overvoltage

DC 40 V

Insulation voltage

Standard: DC 850 V

Increased overvoltage protection
for lightning strikes: DC 50 V

Connection diagrams

4 ... 20 mA, 4 ... 20 mA + HART® (2-wire)	
U+	brown (BN)
U-	blue (BU)
Shield	grey (GY)

DC 0.1 ... 2.5 V (3-wire, low power)	
U+	brown (BN)
U-	blue (BU)
S+	black (BK)
Shield	grey (GY)

2 x 4 ... 20 mA (2 x 2-wire, galvanically isolated)	
U+ (pressure sensor)	brown (BN)
U- (pressure sensor)	blue (BU)
U+ (temperature sensor)	green (GN)
U- (temperature sensor)	white (WH)
Shield	grey (GY)

2 x DC 0.1 ... 2.5 V (3-wire, low power)	
U+	brown (BN)
U-	blue (BU)
S+ (pressure sensor)	black (BK)
S+ (temperature sensor)	green (GN)
Shield	grey (GY)



Legend

U+ positive power supply terminal

U- negative power supply terminal

S+ analogue output

Approvals (option)

Logo	Description	Country
	EU declaration of conformity <ul style="list-style-type: none"> ■ EMC directive EN 61326 emission (group 1, class B) and interference immunity (industrial application) ■ RoHS directive ■ ATEX directive ¹⁾ <ul style="list-style-type: none"> - Ex i Zone 0 gas [II 1G Ex ia IIC T4/T5/T6 Ga] Zone 1 gas [II 2G Ex ia IIC T4/T5/T6 Gb] 	European union
	IECEX ¹⁾ Hazardous areas <ul style="list-style-type: none"> - Ex i Zone 0 gas [Ex ia IIC T4/T5/T6 Ga] Zone 1 gas [Ex ia IIC T4/T5/T6 Gb] 	International

1) Only available with output signals 4 ... 20 mA, 2 x 4 ... 20 mA and 4 ... 20 mA + HART®.

Manufacturer's information and certificates

China RoHS conformity

SJ/T 11364-2014

Approvals and certificates, see website

Dimensions in mm [in]

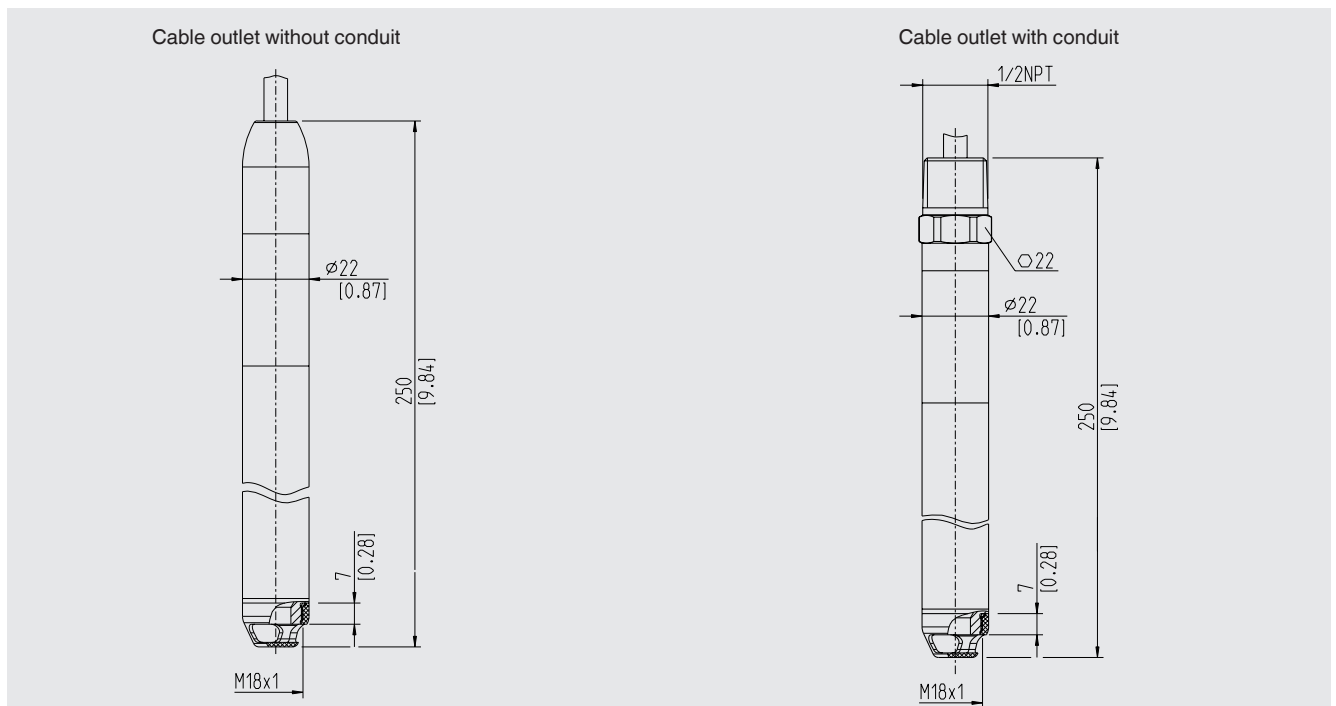

Accessories

	Description	Order number
	<p>Additional weight The additional weight increases the dead weight of the submersible pressure sensor. It simplifies the lowering in monitoring wells, narrow shafts and deep wells. It effectively reduces negative environmental influences of the measuring medium (e.g. turbulent flows) on the measuring result.</p> <p>Stainless steel 316L, approx. 300 g (0.661 lbs), length 115 mm (4.53 in)</p>	14131008
	<p>Cable strain relief clamp The cable strain relief clamp ensures easy and secure mechanical fastening of the submersible pressure sensor's cable. It serves to guide the cable to prevent mechanical damage and to reduce the action of tensile stresses.</p>	14052336
	<p>Cable box The terminal box, with IP67 ingress protection and waterproof ventilation element, provides a moisture-free electrical termination for the submersible pressure sensor. It should be mounted in a dry environment, outside any shafts or vessels, or directly in the switch cabinet.</p> <p>Not suitable for hazardous areas!</p>	14052339
	<p>Intrinsically safe repeater power supply, model IS Barrier Input 0/4 ... 20 mA, supplying and non-supplying Bidirectional HART® signal transmission</p> <p>For details see data sheet AC 80.14</p>	14117118
	<p>Indication and programming module HART® DIH50 and DIH52 5-digit display, 20-segment bar graph, without separate power supply, with additional HART® functionality. Automatic adjustment of measuring range and span. “Secondary-master” functionality: Setting the measuring range and unit of the connected transmitter using HART® standard commands possible. Optionally explosion protection per ATEX.</p>	on request
	<p>HART® modem with USB, RS-232 or Bluetooth® interface For scaling the measuring range using a PC via the HART® protocol, a HART® modem with USB, RS-232 or Bluetooth® interface is available. The modem communicates with all registered HART® field instruments and can be used with the most popular HART® compatible software programs.</p>	7957522 (RS-232 Interface)
		11025166 (USB interface)
		11364254 (Bluetooth® interface)

Ordering information

Model / Measuring range / Output signal / Accuracy / Case material / Cable outlet / Cable material / Cable length / Overvoltage protection / Medium temperature / Approval / Accessories

© 12/2016 WIKA Alexander Wiegand SE & Co. KG, all rights reserved.
The specifications given in this document represent the state of engineering at the time of publishing.
We reserve the right to make modifications to the specifications and materials.



WIKAL Alexander Wiegand SE & Co. KG
Alexander-Wiegand-Straße 30
63911 Klingenberg/Germany
Tel. +49 9372 132-0
Fax +49 9372 132-406
info@wika.de
www.wika.de