

"PROPER SPECIFICATION AND INSTALLATION OF INDUCTION MOTORS"

Copyright Material IEEE
Paper No. PCIC-95-31

W.R. Finley, Senior Member IEEE
R.R. Burke, Senior Member IEEE

Motors & Drives Division
Siemens Energy & Automation, Inc.
Norwood OHIO

ABSTRACT

When selecting a motor, decisions must be made as to characteristics of performance, degree of protection, and maintainability. A minimum suitable motor for the application is chosen, then evaluations of the expense related to increased protection and optional features and performance. After receipt, the motor must be installed and maintained properly to give the long and trouble-free life desired.

INTRODUCTION

This paper discusses the minimum acceptable motor for the application and includes recommendations for selecting additional features and higher protection and performance, plus recommendations for installation and maintenance.

- O Motor Selection
 - Enclosure
 - Temperature Rise
 - Stator/rotor construction
 - Vibration level desired
 - Bearings
 - Insulation
 - Noise
 - Torque/Inrush current
- O Environment
 - Moisture/Dirt/Ambient Air
 - Power Supply
 - Base Design
- O Installation and Control Settings
- O Commissioning Tests

To achieve years of trouble-free operation, the proper motor for the application must be chosen. This requires that the motor be properly specified for the specific application, taking into

account any special ambient conditions, performance requirements, or environmental concerns. Without this, nothing else will matter.

CHOOSING THE PROPER ENCLOSURE

The most commonly used enclosures are the Open Drip Proof (ODP), Weather Protected Type I (WPI), Weather Protected Type II (WPII), Totally Enclosed Air to Air Cooled (TEAAC), Totally Enclosed Fan Cooled (TEFC), and Totally Enclosed Water to Air Cooled (TEWAC). They come with varying degrees of protection and cost. It is important that an enclosure is chosen which gives adequate protection, but over protecting could add needless cost to the user.

OPEN DRIP PROOF (ODP) (IP12)(IC01)

The open drip proof motor offers minimal protection against the elements. It will resist the entrance of water which falls at an angle less than 15° from the vertical. It is not suited for outdoor applications or a dirt filled environment. See Figure 1A. But, it is the workhorse of the industry, offering economical, rugged service for indoor clean environment. If there is a concern with rodents, birds, or other objects entering the machine, a machine with greater protection, such as the WPI machine, should be used.

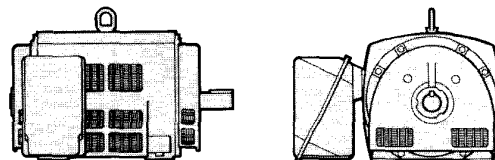

Figure 1A - Typical ODP/WPI Enclosure

WEATHER PROTECTED TYPE I (WPI) (IP22) (IC01)

This machine is very similar to the ODP except for the use of either screens or louvers to help prevent the entrance of objects typically greater than 3/4 inch in diameter as defined by NEMA. See Figure 1A. This machine is not suited for a harsh outdoor application or where there is a large amount of airborne elements such as lint as may be seen in a textile factory. A special concern is abrasive dust as may be seen in the mining industry or a steel mill. In a dirtier environment, a pressurized clean room could be utilized or a machine with greater protection such as a WPII enclosure with filters or a totally enclosed type of machine should be considered.

WEATHER PROTECTED TYPE II (WPII) (IP24W)(IC01)

This machine minimizes the entrance of wind blown snow or rain and is suitable for outdoor applications. The machine is designed with blow throughs, so that high velocity air and airborne particles blown into the machine can be discharged without entering the internal ventilating passages leading directly to the electrical parts of the machine. See Figure 1B. It can be provided with filters to remove a high percentage of dust particles as long as they are greater than 10 microns in size. It must be noted that the filters should be kept clean and pressure drops across filters should not exceed .5". This machine is designed with an air flow path on the intake which makes (3) 90° bends and has a low velocity area of less than 600 ft/min. to allow the heavier particles to drop out. Larger, lighter particles should be caught by the filters.

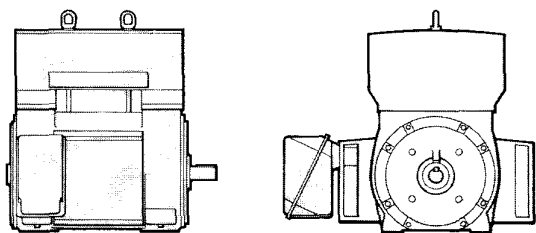

Figure 1B - Typical WPII Enclosure

Situations are seen in the field where the dirt in the air is so thick that the filters need to be cleaned too frequently. It is not a good idea to remove the filters to avoid this extra maintenance since this dirt will most probably clog the air passages through the coil end turns or through the rotor and stator vents. This will cause the motor to overheat. In an extreme, but true, case involving a wood hog application, the ODP motor would fill up with saw dust to about shaft level in less than two months. The motor would then ignite and burn. It was reported that the motor continued to run and burn for more than 15 minutes at rated load while the operator sprayed fire extinguishers into the intakes. This is obviously a very severe duty cycle for which the motor was not designed. Clearly, it was not a good idea to remove those filters which

came with the motor. The solution here is to duct in air from a clean source or change to a TEFC type enclosure.

TOTALLY ENCLOSED MOTORS (IP54)

There are a number of variations of these machines, all of which offer a high level of protection against dirt and rain and the environment.

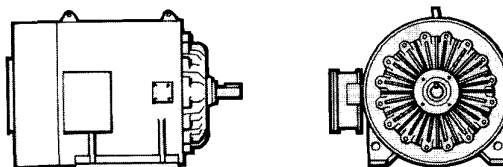

Figure 1C - Typical TEAAC Enclosure

TOTALLY ENCLOSED AIR TO AIR COOLED (IP54)

(TEAAC) machines designed with cooling tubes are well suited for dirt and rain. See Figure 1C and 1D. In many cases, a TEAAC motor has the advantage of being able to be built with the same basic design as the open motor leading to greater standardization. The air to air cooled machine has greater horsepower output per active electrical material than a TEFC fin-cooled machine and has cooler internal air circulation. However, due to the expense of the heat exchanger the TEAAC motor is normally more expensive. Another drawback of the TEAAC at times is the large size, particularly the top mounted tube bundle. Under some extreme environmental conditions the tubes may even clog.

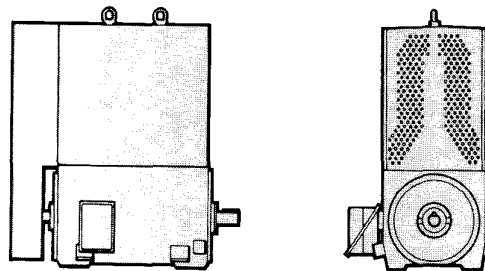

Figure 1D - Another Typical TEAAC Enclosure

THE TOTALLY ENCLOSED FIN COOLED (TEFC) (IP54,

IC411) design is the one that can withstand the dirtiest environment. See Figure 1E. It has no tubes or air passages to clog and can be easily hosed down if the fins get caked with dirt.

This motor can be equipped with an interlocking rotating shaft seal and is suitable for the harshest environmental conditions. If the motor is subject to down time, it should be equipped with a drain, breather, and a space heater which is turned on when the motor is deenergized. Of course, this is true for all enclosures.

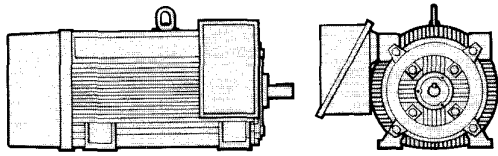

Figure 1E - Typical TEFC Enclosure

Even when the machine appears water tight, the motor still breathes in air when it cools off. With the air comes moisture which condenses on the winding and builds up inside the enclosure. A drain plug is normally not advisable since it must be removed to drain the water and this may be forgotten. A breather/drain plug should be used on TEFC machines.

THE TOTALLY ENCLOSED WATER TO AIR COOLED (IP54) (TEWAC) machine is normally not affected by dirt and rain, but a source of water for the water cooler must be provided. See Figure 1F. This machine has a high level of protection and is not greatly affected by local ambient conditions, but the motor is considerably more expensive.

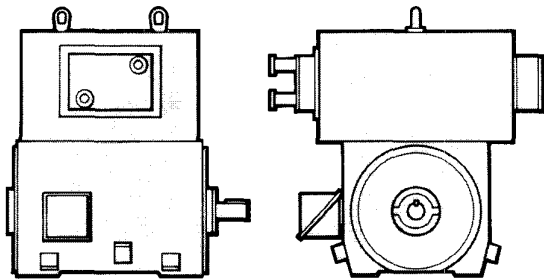

Figure 1F - Typical TEWAC Enclosure

THE TOTALLY ENCLOSED PIPED VENTILATED (IP44, IC31 or IC37) machine has the advantage of not being affected by dirt and rain, but a source of clean air and an auxiliary blower must be provided. This machine typically will be built on the same frame as the open machine, but will be provided with flanges for connections of ductwork. With special precautions and when properly pressurized, the machine can be used in a Division I area.

AMBIENT CONDITIONS

Once the enclosure is chosen, the ambient air or water temperature must be determined. The majority of problems causing motors to overheat can be traced back to a misunderstanding of the ambient temperature to which a motor is actually subjected.

Just because a motor is located up on a mountain and only used in the winter time does not mean that the ambient air will be less than the standard 40°C and the motor must also contend

with the altitude. Remember, the motor only sees the air at the air intakes and it only takes a failure at one location on the winding to cause an expensive repair bill. Heat comes from many sources and many times there are pockets of hot air on the drive end of the motor as a result of heat coming off the driven load or poor air circulation due to obstructions of components in that area, such as terminal boxes, pipes, ductwork, and other motors. It is recommended that when commissioning a motor, the technician place a thermocouple or thermometer on each air intake and monitor the inlet air temperature over a long enough period of time to ensure that all the normal duties are observed. One must also take into account the hottest day of the year and how it would affect or change what was observed. If the air going into the motor is higher than expected, the air circulation must either be corrected or the motor load reduced to compensate.

When a motor is located in a high altitude, the air is less dense, thereby reducing its cooling effects. At times, the detrimental effects can be extensive. The higher temperature can be calculated from the following formula:

$$\text{Temperature Rise at Altitude} = \text{Temp. Rise at Sea Level} \left[1 + \frac{\text{Alt} - 3300}{33,000} \right]$$

POWER SUPPLY VARIATIONS

Many problems are a result of high or low voltage, unbalanced voltage, ungrounded power systems, or voltage spikes.

LOW VOLTAGE is normally not the direct cause of motor overheating since the overload relays will kick the motor off line when the current exceeds rated amps, but as a result the motor will not generate rated HP. The motor slip also increases proportionally to the square of voltage drop. As a result, the motor will be running slower with a lower output and the process would not be producing as expected. Low voltage during start can create additional problems. When specifying the motor, it is important to understand what the true voltage at the motor terminals is during starting. This is not the power system voltage, or the tap on the auto transformer. To determine this voltage, one must take into account the total line drop to the motor terminals during the high current draw which is present while the motor is starting.

On designs which are subject to reduced voltage start and have a high risk of not properly starting, it is recommended that the voltage at the motor terminals be measured on the first couple of starts to eliminate concerns or problems in the future.

OVERVOLTAGE

It is normally true that motors tend to run cooler at rated horsepower at voltages exceeding rated voltage by up to 10% , but the current draw is only controlled by the load and at rated current and 10% overvoltage the motor will be overloaded by approximately 10%. The core loss is 20 to 30% greater than

normal and could cause the machine to overheat. If it is verified that the motor will see an overvoltage, the overload current relay must be adjusted downward to compensate, or stator temperature detectors should be used to monitor the temperature.

UNGROUNDING POWER SYSTEMS

An ungrounded power system is a serious concern that, if not properly addressed, can lead to very early motor insulation failure. Other than the possible higher voltage stress on the insulation system, this voltage condition will have little effect on the motor performance. On a well balanced grounded power system, the voltage line to neutral (VL-N) will equal the voltage line to ground, but this is not necessarily true on an ungrounded system.

On an ungrounded system, it is not unusual to see voltage swings in the power supply to the motor, causing the voltage line to ground to approach the magnitude of line to line voltage. For example, on a 4000 volt system the line to ground voltage should be $4000/\sqrt{3} = 2300$ volts. The voltage swing can increase the voltage seen across the ground wall insulation to as much as 4000 volts. The voltage may be even higher, depending on the power supply and possible fault conditions. A standard 4 KV motor has an insulation from coil to ground which is only good for 2400 volts $\pm 10\%$. In the condition where the line to ground voltage is 4000 volts, the motor must be provided with an insulation system suitable for a $4000 \times \sqrt{3} = 6800$ volts L-L.

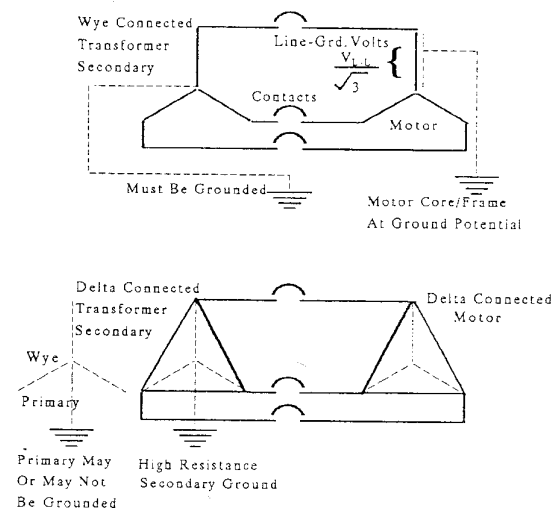

FIGURE 2

This condition is even more common and severe when operating on a variable frequency power supply. We have seen reported conditions where the voltage line to ground can exceed the line to line voltage by 20% or more.

Motors can typically withstand short infrequent durations of high line to ground voltage, such as would be seen in clearing a

ground fault, but support equipment such as capacitors or other electronic equipment can be quickly and easily damaged. Presently, a NEMA proposal is out for ballots adding the above mentioned warning to NEMA Standards. This will alert users to this concern.

If an application does exist in which a motor will be subjected to high line to ground voltage, the motor manufacturers must be alerted to provide a motor and other equipment suitable for this overvoltage condition. Alternately, one may wish to provide phase to ground over voltage protection. Note that phase to phase overvoltage protection will not identify the problem since phase to phase voltage may not change significantly with a ground fault or as a result of a voltage swing on an ungrounded system.

SURGE AND TRANSIENT PROTECTION

Defining the need for surge protection is not easy. This is a risk versus reward type scenario and will vary depending on the cost and necessity of the equipment being protected. A general guide to when surge protections can be beneficial is as follows.

Lightning Arrestors should be used on machines where there is good possibility of lightning strikes on the power lines, transformer or the motor, or, if the motor is large (expensive), and is on a known unstable system or a system capable of producing high magnitude switching surges, typically above 5 per unit line to ground.

Surge Capacitors should be used on large expensive machines, where it makes good sense to provide cheap insurance against turn to turn motor failure, or on machines on any system capable of producing fast front (<.5 usec) or high magnitude (>3.5 P.U.) switching surges.

Note: With some motor manufacturers, or on random wound machines, these levels may be lower.

UNBALANCED VOLTAGES

Unbalanced voltages will produce negative sequence currents which will produce excess heating in the stator winding and rotor bars, but will not produce useful power output. Derating of the motor is necessary when unbalanced voltages exceed 1% as defined by the attached curve.

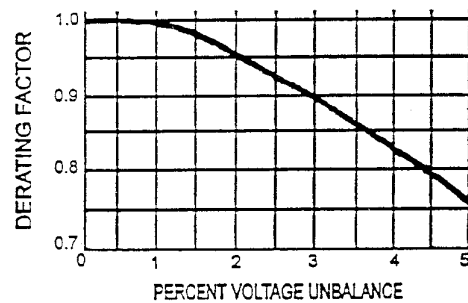

Figure 3 - Derating Factor

MOTOR SPECIFICATION

All the previously mentioned topics make up the motor environment. Each affects the motor in its own way and must be considered when choosing or specifying a motor. Next, one must consider the applications or equipment the motor is driving and provide the proper motor. We will not cover motor applications - this was covered in "Trouble Shooting Motor Problems" (4) - but we will identify special motor considerations that should be considered in the motor specification.

Proper motor specifications should consider the following in addition to the environmental concerns already mentioned:

Temperature Rise	Insulation
Vibration	Noise
Stator Construction	Torque
Rotor Construction	Inrush
Bearings	

STATOR CONSTRUCTION AND TEMPERATURE RISE AND INSULATION

Induction motors have two types of stator windings. Their use typically depends on line voltage.

- Random Wound (Mush Wound) Stator - Below 600 Volts See Fig. 4
- Form Wound Stator - Above 600 Volts See Fig. 5 A

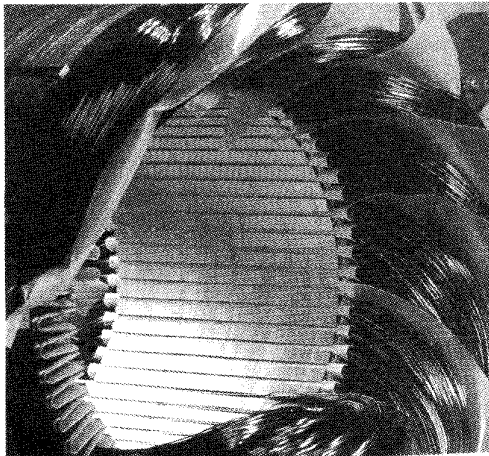

Figure 4 - Typical Low Voltage Winding

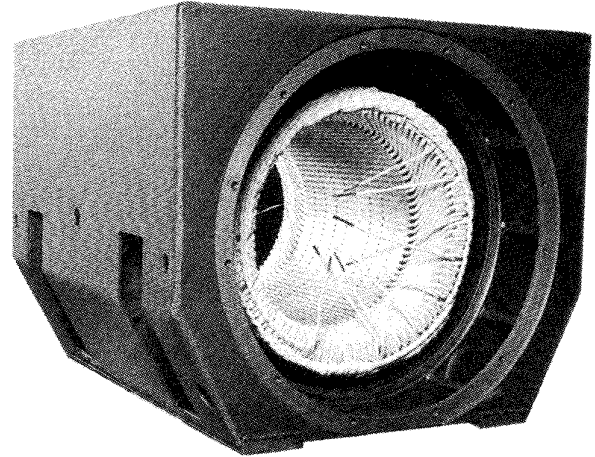

Figure 5A - Typical High Voltage Winding

On a given frame size and core length, random wound machines tend to be more economical, generate less losses, run cooler, and have a higher efficiency. The frame size can be smaller for a specific horsepower to achieve the same temperature margin as form wound machines. The primary source, for the reduction in loss, is the semi closed stator slot which reduces the core loss by 20 to 30%. This also provides the ability to get more stator copper in the slot. This is due to the lack of ground wall tape and tapered stator slots which can more effectively utilize the core area. (See Fig. 6.)

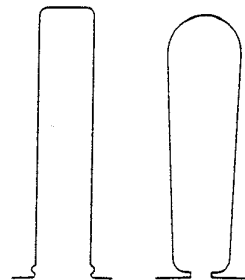

Fig. 6 - Typical Form Wound and Random Wound Slot Shape

There are a couple of reasons that a form wound stator may be a better choice on some low voltage applications. On random wound stators it is difficult to keep the round wire of the first and last turn in each coil group separate as can be seen in Figure 4. As a result, the turn to turn voltage stresses are greater and little can be done on higher voltages except to use form wound coils. In addition, on the end turns coils cannot be kept separate. The only separation would be provided by the phase insulation between phase coils.

One reason to use form wound coils would be when high voltage spikes with a rapid wave front are expected. Since each turn on a random wound machine is not located in a

uniform fashion within the coil, the first and last turn may be side by side. This increases the voltage stress between turns. In this situation high frequency spikes may drastically shorten the life of the machine. This would not be the case on a form wound machine where the first and last turn are normally at the top and the bottom of coil. See Fig. 5B.

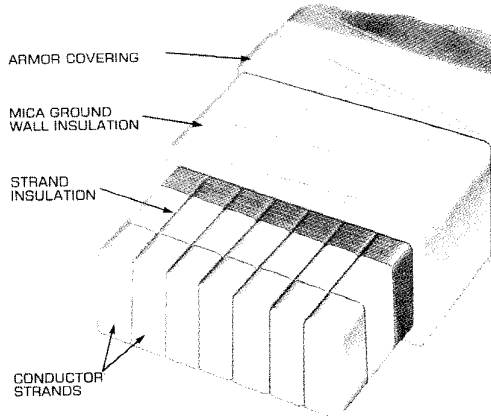

Figure 5B - Form Wound Coil

On machines subject to severe duty, shock loading such as shredders or crushers, a form wound stator which is vacuum pressure impregnated (VPI), along with the use of heavy duty coil supports, can significantly stiffen the end turns, reducing end turn movement and extending life expectancy. On motors which are subject to multiple restarts of high inertia loads (greater than NEMA recommends), form wound coils are preferred.

Most machines today are built with Class F insulation. There is little reason to go to a higher insulation class, since at higher temperatures bearings run hotter with a much greater possibility of bearing failure. Listed below is a composite of allowable temperature limits for the insulation classes as defined by both NEMA MG1 (5) and ANSI CR50.41 (6).

STATOR TEMPERATURE RISE STANDARDS (5) (6)

Method of Temperature Determination	Motor Rating and Voltage	Maximum Winding Temperature Rise °C						
		1.0 Service Factor				1.15 Service Factor		
		Class A	Class B	Class F	Class H	Class A	Class B	Class F
Resistance	All	60	80	105	125	70	90	115
Embedded Detector	1500 HP or Less	70	90	115	140	80	100	125
	More than 1500 HP							
	a. 7000 Volts or less	65	85	110	135	75	95	120
	b. More than 7000 Volts	60	80	105	125	70	90	115

ROTOR CONSTRUCTION

There are three types of rotor construction used today. They are:

- Aluminum Die Cast (ADC)
- Fabricated Aluminum Rotors
- Fabricated Copper Bar Rotors

The aluminum die cast rotor is the most economical and is extremely reliable for most normal applications where the load inertia (Wk^2) is less than that defined by NEMA and not subject to long stalled conditions or require extremely high starting torques. This design is excellent for more than 90% of motor applications.

The fabricated aluminum rotors have limitations similar to ADC rotors, but are considerably more expensive. There is limited value in this type of design. It is not widely used in the industry.

The fabricated copper bar rotor may be used on larger machines where ADC is not available or where special circumstances dictate its use. Some of these are:

- High inertia application
- Multiple starts per hour of high inertia load
- Crusher or shredder duty applications
- High torque application
- Higher efficiency

When 100% copper rotor bars are used for higher efficiency, the torque is less than would be achieved with an aluminum rotor. High resistance copper bars would need to be used to achieve higher torque as with the ADC rotor. This would defeat the intent of high efficiency. Aluminum die cast rotors are excellent for multiple starts per hour when the Wk^2 is low enough not to cause thermal stressing on start up. Such an application would be a hydro pulper. The rotor bar is held tightly on start preventing bar movement and breakage. If copper bar rotors are not held tightly in the slot, they will eventually fatigue and break on long duration starts.

VIBRATION

The NEMA vibration specification, contained in MG1-20.53 (5) for large induction motors and in NEMA MG1-12.07 for small and medium machines is shown in Figure 7. These vibration limits are for measurement on the bearing housings.

Speed, RPM	Peak to Peak Amplitude, Inches	
	NEMA-MG1-20.53	NEMA-MG1-12.07
3000 and above	0.001	0.001
1500 - 2999, incl.	0.002	0.0015
1000 - 1499, incl.	0.0025	0.002
999 and below	0.003	0.0025

Figure 7

NEMA is currently in the process of updating the vibration specifications. Some users have developed a more stringent vibration standard on a plant or company basis. The measurement of the velocity of vibration, in inches per second, instead of displacement, in thousandths of an inch - mils - is becoming popular in some areas, with the belief that velocity more accurately measures the force of vibration. Figure 8 shows the relationship of mils to inches per second for measurement of vibration.

CYCLES PER MINUTE	DISPLACEMENT MILS P-P	VELOCITY INCHES/SEC	
720	1	.038	Comparison of
900	1	.047	displacement in
1200	1	.063	mils and velocity
1800	1	.094	inches per
3600	1	.188	second at common
7200	1	.376	frequencies.

Figure 8

Very restrictive vibration specifications may result in motors being more expensive than expected, and are often not cost effective. For instance, a very restrictive 120 Hz specification requires building a larger than normal motor, so that the magnetic forces can be maintained at a low level. When a vibration specification is written, it should contain only items necessary for the application.

BEARINGS

Selection of the type of bearing is easy on very small and very large machines, since there is only one choice for each. However, in the range where either anti-friction or sleeve bearings can be used, several operating and maintenance conditions should be considered:

- Sleeve bearing motors should be checked every day for oil level and vibration.
- Anti-friction bearings need to be greased at designated intervals.
- Sleeve bearings cannot be used for side loads or vertically upward loads, as with belt drive motors, unless very special designs and arrangements are made.
- Drive end sleeve bearings can usually be changed without disturbing the coupling, shaft alignment, foundation bolts, or electrical connections. Often, these items need to be undone to replace a drive end anti-friction bearing.

Figure 9 shows a comparison of considerations to help in selection of the type of bearing to specify for a motor.

	COMPARISON	
	SLEEVE OIL LUB.	ANTI-FRICTION GREASE LUB.
RELIABILITY	HIGH	HIGH
LIFE	HIGH	HIGH
COST	MODERATE	LOW
MAINTENANCE REQUIREMENTS	MODERATE	MODERATE
DESIGN TOLERANCE TO LEAKAGE	MODERATE	HIGH
TOLERANCE TO CONTAMINATION	MODERATE	MODERATE
TOLERANCE TO AMBIENT TEMP EXTREMES	LOW	MODERATE
TOLERANCE TO HIGH TEMP BEFORE FAILURE	LOW	MODERATE
TOLERANCE TO INSUFFICIENT LUB	LOW	MODERATE
EASE OF ASSEMBLY / DISASSEMBLY	MODERATE	HIGH
SPACE REQUIREMENT	MODERATE	MODERATE
DAMPING	HIGH	LOW
TOLERANCE TO VIBRATION (< .2 ips)		
a. ON BRG LIFE	VERY HIGH	MODERATE
b. ON RELUB. FREQUENCY	VERY HIGH	MODERATE
TOLERANCE TO MISALIGNMENT	MODERATE *	MODERATE
TOLERANCE TO OUT OF LEVEL MOTOR MOUNTING	LOW MODERATE	
TOLERANCE TO RESIDUAL AXIAL LOAD	NONE	LOW
TOLERANCE TO RESIDUAL RADIAL LOAD	LOW**	MODERATE
STIFFNESS	MODERATE	HIGH
POWER LOSS	MODERATE	LOW

* WITH CENTER SUPPORT DESIGN
** MODERATE IN THE DOWNWARD DIRECTION

Figure 9

In most machines where both anti-friction and sleeve bearings are available, either will give satisfactory service.

NOISE

Unwanted noise can be the result of either magnetically generated structure borne vibrations, or air borne windage noise. There are many different ways to design motors for low noise. The noise can be treated or the vibration eliminated at the source. Sound reduction material can be used, along with various enclosures to reduce noise to desired levels.

When specifying a motor to have low noise, it should be understood how this noise is measured and tested. The industry standard for noise measurement is IEEE '85 (7) which defines various ways to measure the average free field noise level of an unloaded motor. It is important to understand that the noise level measured in the field (area) around the motor could be much higher when adding other noise sources and the reverberant room effects. The results could be as follows:

Additional Noise

dBA of motor no load, free field	85
Possible increase in motor noise under load	2
Driven Equipment Noise Level	87 (Example)
Typical addition for room ambient noise	+ 2 typical
Typical addition for semi-reverberant effects of room	+ 3 typical
$L_{pTotal} = 10 \text{ Log } \left[\frac{\text{antilog}(85 + 2)}{10} + \frac{\text{antilog}(87)}{10} \right] + 2 + 3$	
= 95 dBA Measured Around Motor in the field	

As can be seen from the above analysis, the room surroundings and ambient conditions can greatly affect noise levels. This analysis should be taken into account when specifying a motor to eliminate surprises. For more detail on noise see "Motor Noise - Causes and Treatments." (2)

CONTROL SETTINGS

The following are typical control settings that can be used to adequately protect a motor. These levels may be different than what is needed to protect other equipment in the system. Protection of the complete system must be considered. For example, shaft vibrations of 3.3 mils on 2 pole motors may be alright for the motor, but could do serious damage to the driven equipment. In addition, many 2 pole motors are designed for shaft vibration levels of 1.5 mils and lower. Thus a trip setting closer to 2 mils for shaft vibration on low vibration 2 pole motors may be more reasonable.

TYPICAL CONTROL SETTING - MOTOR CONTROL

	Trip Alarm	Timer (Shutdown)	Setting (1)
Winding Temperature (Class F Insulation)	155°C	170°C	
Motor Bearing Temperature (Thermocouple or RTDs)			
Sleeve Bearing	95°C	100°C	
Anti-Friction Bearing	100°C	105°C	
Ground Fault	4 Amps ⁽²⁾	8 Amps ⁽²⁾	.2 sec.
	Primary Circuit	Primary Circuit	
Instantaneous Overcurrent			
With 1/2 Cycle Dampening		1.8 times Locked Rotor Amps ⁽²⁾	
Without Time Delay Dampening		2.4 times Locked Rotor Amps ⁽²⁾	
Maximum Overvoltage	110% of Rated Voltage	60 sec.	
Maximum Undervoltage	90% of Rated Voltage	60 sec.	
(the maximum undervoltage also applied to start unless otherwise specified)			
Maximum Frequency Deviation	±5%	60 sec.	
Maximum of Voltage Plus			
Frequency Deviation	±10%	10 sec.	
Maximum Voltage Unbalance ⁽³⁾	1%	60 sec.	
Maximum Current Unbalance ⁽³⁾	8%	60 sec.	

Suggested vibration limits (mils, peak-to-peak) to protect the motor:

RPM	3600	1800	1200	900 and Slower
Housing	1.0	1.8	2.4	3.0
Shaft	3.3	3.7	4.3	5.0

(1) Maximum time at maximum condition before control device is to operate.

(2) Increase as necessary to avoid nuisance trips.

(3) This is the maximum deviation from the average of the three phases.

BASE DESIGN

The base, or mounting surface, on which a motor is located influences the vibration, bearing behavior, coupling alignment and maintenance of a motor. Two types of satisfactory bases are commonly used - massive concrete bases and structural steel bases.

Reinforced concrete makes a very satisfactory base, particularly for large motors and driven units. With a mass of

approximately 2 1/2 times total weight of motor and driven load, it provides rigid support that minimizes deflection and vibration. A concrete base may be located on soil, structural steel, or building floors, provided the total weight - motor, driven unit, foundation - doesn't exceed the allowable bearing load of the support. Before pouring the foundation, hold down bolts should be located by use of a template frame. A steel base or soleplates should be used between motor feet and the concrete foundation. Space should be allowed for grouting the base or soleplates, so that they can be cast level and in the same plane.

Concrete bases are able to provide sufficient stiffness that base resonant frequencies are normally well above operating speeds, and shaft alignment remains constant.

Structural steel bases are adaptable to special building and machinery configurations. They are usually lighter, and can be fabricated off-site so that installation time is minimized.

Stiffness of structural steel bases must be designed so that the unit - motor, driven load, base-resonance is well removed from exciting frequencies. Major exciting frequencies to avoid are rotational frequencies, line frequency, twice rotational and twice line frequency. 30% is usually a comfortable margin between exciting frequencies and resonant frequency.

Resonant frequency of the base structure can be defined, in simplest terms, as:

$$f_R = 187.7 \sqrt{\frac{S}{P}}$$

where f_R is resonant frequency in cycles per minute

P is weight or force supported

S is stiffness of base in pounds per inch

Forces/weights in all directions must be considered, i.e., horizontal, vertical, and axial. Sleeve bearing motors must be level to maintain the proper oil level and ensure free turning oil rings.

COMMISSIONING TESTS

- When first installing a motor in the field there are various tests that should be performed to ensure satisfactory operations and long life. After the motor has been installed and aligned, but before the motor is coupled to the driven machine, the following checks should be made.
- If the motor has oil lubricated bearings, the oil should be to the proper level. Grease lube bearings are usually shipped with bearings already packed with grease.
- Listen and feel for rubbing or binding while rotating shaft. Shaft should rotate freely, and if sleeve bearing, move axially freely while rotating. Also, if sleeve bearing, check oil rings for smooth rotation.
- Check that all foundation bolts are tight.

- Check that the shaft of a sleeve bearing motor is level within .015 inches. A sleeve bearing motor must be level to maintain the proper oil level and ensure free-turning oil rings.
- Check shaft alignment, rotating shafts together. Remember that it is the shafts, not the couplings, that must be aligned. Check the parallel and angular alignment. See Figure 10. In the absence of a company policy on alignment, use 0.002 inches TIR as a limit.

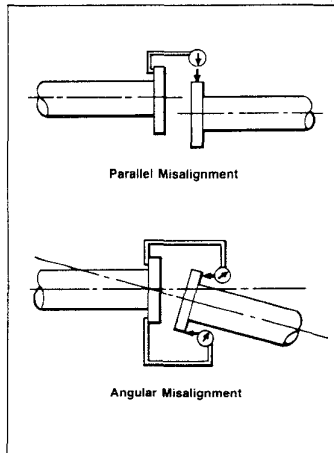

Figure 10 - Shaft Alignment

- Check shaft float of a sleeve bearing motor to be sure that motor shaft will be axially restricted by the shaft coupling so that the shaft shoulders do not contact either face of the bearing bushing when coupled and operating.
- Check for "soft foot" or foot plane. The proper foot plane is when adequate shims have been installed to assure equal pressure on each foot or corner of motor when the mounting bolts are loose. To determine proper foot plane:
 1. Mount dial indicator on shaft to be checked so contact will rest on either the adjacent shaft or a bracket from the foundation or base.
 2. With mounting bolts tight and indicators set at ZERO, release one bolt at the drive end of the unit; check indicator for a change in reading (.001" maximum).
 3. If no reading change is indicated, retighten bolt and check the other drive and end mounting bolt.
 4. Add shims, if necessary, until bolt can be retightened with no change of reading.
 5. Using the same procedure, check each of the mounting bolts on the non-drive end of the motor.

A variation of this check is to mount the dial indicator on the base, with the indicator tip on the motor foot adjacent to the mounting bolt being loosened. The foot should move no more than .003 inches when the mounting bolt is loosened. If more than this, the shims need to be adjusted. Recheck shaft alignment after any change of shims.

- If force feed lubrication is used, check to be sure lubrication lines have been flushed thoroughly and are clean before connecting lines to bearing housings. Bearing cavities must be filled with the proper oil, as specified, and to the proper oil level.
- Check that motor, starting, and control device connections agree with wiring diagrams.
- Check that voltage, phase, and frequency of line circuit agree with motor nameplate.
- If motor is equipped with temperature detectors, check that they show the correct indication at this time, before startup, when the motor is at room temperature.

The motor should now be checked while operating, before coupling to the driven load. If the coupling arrangement has shrouds, they need to be tied back out of contact with the rotating part of the coupling. Following checks should be made:

- Check stator installation resistance before starting. If resistance is low, dry out stator before starting.
- Start motor, check vibration, run long enough to be certain that no unusual condition exists. Listen for excessive noise, clicking or pounding. Note vibration, if normal or excessive. If equipped with oil-ring type sleeve bearings, check oil ring rotation. It should be steady, oil flowing freely along rings. Note if temperature detectors are responding with temperature change.
- When starting motor, check direction of rotation. Many machines will operate equally well in either direction of rotation. Larger high speed motors often have directional fans and will overheat if operated in the wrong direction.

When first accelerating check and record for future reference:

Acceleration time
 Voltage during Start-up (Motor Terminals)
 Voltage at Full Speed
 Current during Start
 Current at Full Speed

- Check vibration. Unsatisfactory vibration may be due to operating with only half of a coupling which has been balanced as a complete unit, or a "soft foot", as mentioned earlier, or other reasons. See Figure 11 for common causes of vibration.
- If the motor feet or mounting ring are vibrating excessively, a check for a weak or resonant mounting structure is desirable. If the vibration of the mounting structure immediately below the motor exceeds 30% of the horizontal vibration of the motor bearing housing at the shaft centerline, the motor mounting arrangement may be weak or resonant.
- Check that the exhaust air is not being redirected back into the machine air intakes by adjacent pillars, cabinets, or

ELECTRIC MOTOR DIAGNOSTIC CHART

CAUSE	FREQUENCY	DOMINANT PLANE	PHASE ANGLE RELATIONSHIPS	AMPLITUDE RESPONSE	POWER OUT	COMMENTS
Misalignment ① Bearing	Primarily 2 x Some 1 x	Radial & Axial	① 180° phase shift DE vs. EO ② Phase angle can be erratic	Steady.	Drops slowly with speed.	① 2 x can dominate during coastdown. ② 2 x is more prevalent with higher misalignment.
② Coupling	Primarily 1 x Some 2 x	Radial & Axial	Drive 180° out phase with driven.	Steady.	Level drops slowly with speed.	① Parallel causes radial forces and angular causes axial. ② Load dependent.
Flut - ① Seal/or bearing	1/4x, 1/3x, 1/2x or 10-20x can be seen Primarily 2 x Some 1 x	Radial.	Erratic.	Erratic depending upon severity.	Disappears suddenly at some lower speed.	① Full rubs tend to be 10 to 20x higher. ② Bearing misalignment can give rub symptoms.
② Rotor	1/4x, 1/3x, 1/2x, & 1x with slip freq. side bands.	Radial.	Erratic.	High.		① Severe pounding.
Looseness: ① Bearing (non-rotating)	2 x 3 x may be seen	Radial.	Steady.	Fluctuates	Disappear at some lower speed	① Bearing seat looseness. ② Looseness at bearing split.
② Rotor Core (rotating)	1-10x with 1, 2, & 3 predominant.	Radial	① Can exist relative to type of looseness ② General core loose gives erratic symptom.	Erratic, high amplitude	① Drops with speed. ② Can disappear suddenly.	① End plates loose. ② Core ID loose.
③ Pedestals (non-rotating)	1-10x with 2 & 3 predominant	Radial & Axial	Steady.	Fluctuates.	Disappears at some lower speed.	
④ External Fans	1 & 3x	Radial & Axial - OE (fan end)	N/A	Fluctuates.	① Drops with speed. ② Can disappear suddenly.	
Unbalance Rotor	1x rotor speed.	Radial	① EO & DE in phase ② Couple gives out of phase condition	Steady.	Level drops slowly.	Rotor has unbalance - can be due to thermal problems.
Unbalance of External Fan	1x	① Radial high at EO (fan end). ② Axial with high at EO.	① Couple DE 90° out of phase with EO. ② EO & DE in phase.	Steady.	Level drops slowly.	
Coupling Unbalance	1 x	① Radial high at DE (oplg. end)		Steady	Level drops slowly	Unbalance due to coupling or key
Bent Shaft	2 x Primarily 1 x may be seen	Axial.	EO 180° out of phase with DE.	Steady.	Level drops slowly.	DE runout should give higher 2x axial at that end. Normal runout on core - 1-2 mil.
Top Cover Fit	120 Hz.	① Radial ② Vertical.	N/A	Steady.	Disappears immediately.	① Real time zoom shows magnification of 120 Hz electrical. ② Top cover rests on basic core support.
Eccentric Air Gap	Strong 120 Hz Some 1 x may be seen	Radial.	N/A	① Results in strong 2 pole beat. ② Due to difference freq. at 120 Hz. with difference of at twice slip.	Immediately drops	① Air gap ratios from one side to the other, should be 0.10 or greater. ② Very load sensitive.
Eccentric rotor	1x Primarily Some 60 & 120 Hz	Radial.	Unsteady.	① Steady, if not extreme case.	Immediately drops	① Eccentricity limit 1-2 mil. ② Load sensitive. ③ Slip beat changes w/speed
Loose stator core	120 Hz.	Axial & radial.	Frame & bearing brackets in phase at 120 Hz.	Steady	Immediately drops	① Look for relative motion of core with respect to housing.
Rotor Bow (Thermal Bow)	1x Dominant 120 Hz may be seen slip beat	Radial	Unsteady	① Changes with temperature. ② Time or load related. ③ Varies at Freq. slip x poles	Some drop but high level would come down with speed.	① Heat related. ② Examine rotor stack for uneven stack tightness or looseness. ③ Shorted Rotor Iron ④ Check bar looseness.
Broken rotor bars	① Dependent upon no. of broken bars. ② 1x with twice slip side bands. ③ High stator-rotor slot frequencies.	Radial.	Dependent upon where fractures are located.	STRONG BEAT POSSIBLE. - Varies @ Freq. slip x poles - Amplitude increased with load	Immediately drops	① Sparking in the air gap may be seen. ② Long term variation in slot frequencies can be indicator of bar problems. ③ Broken bars cause holes in magnetic field. ④ Large current fluctuations. ⑤ Current analysis shows slip frequency side bands.
Loose bars.	① Stator & rotor slot freq. ② Possible balance effect with thermal sensitivity. ③ Stator slot freq plus sidebands @ s(Ns-Nr)	Radial	Excess looseness in 2 pole motor can cause erratic phase angle.	① Considerable variation. ② 0.1 ips, at idle, may be questionable ③ Monitor change with time. ④ Amplitude pulsates at slip RPM x # poles	① Immediately disappears. ② Load sensitive. ③ Imbalance effect can suddenly disappear at some lower space. ④ Immediately disappears.	① Average data required because of variation. ② Note that these frequencies vary normally by a factor of two to three free idle to full load. ③ Excessive looseness can cause balance problems in high speed motors.
Interphase fault	60 & 120 Hz	Radial	N/A	Steady and possible beat	Immediately disappears	
Ground fault	60 Hz & 120 Hz slot freq.	Radial	N/A	Steady and possible beat.	Immediately disappears.	
Unbalanced Line Voltages	120 Hz	Radial	N/A	Steady 120 Hz & possible beat.	Immediately disappears.	
Electrical Noise Vibration	(RPM x # of Rotor slots)/60 +/-120, 240, etc.		N/A	Steady	Immediately disappears	
System Resonance	1 x RPM	One plane - usually horizontal	Varies with load and speed	Varies	Disappears rapidly.	Foundation may need stiffening - may involve other factors
Strain	1 x RPM					Caused by casing or foundation distortion from attached structure (piping).
Poorly shaped Journal	2x Rotational Usual					
Oil Film Instability (Oil Whirl)	Approx. 1/2 Rotational (.43 - .48)	Radial	Unstable	Steady		
Anti-Friction Bearing Problems	Various Frequencies dependent on bearing design		Unstable	Steady		
Resonant Parts	At forcing frequency or multiples			Steady	Drops rapidly	May be adjacent parts

FIGURE 11

other air blockages. If so, this condition needs to be corrected so that only cool air enters the motor.

- Check for oil leaks if bearings are oil lubricated.
- Make any final checks before shutting motor down to couple to driven load. If motor is equipped with temperature detectors, check to see that they are responding in a reasonable manner.

The motor may now be shut down, the shaft coupling and coupling guard assembled. Be sure to assemble the shaft coupling per the match marks, if it has them.

- Adjust the driven machine for the lowest load possible. Start the motor and note the accelerating time. Acceleration time can be compared to the design expected time to determine if there is a potential problem. If they are close, no further action is required. If the acceleration time is much greater than anticipated, the motor may be close to hanging up and may see large variations in acceleration times depending on ambient and voltage conditions. Nuisance trips could be experienced on future starts. Low voltage during start could be the problem. Check the current at full speed to see if the load is as expected. A high load at start could also cause a long acceleration time.

Compare readings of each phase. Voltages should be equal within one percent, likewise the three ampere readings should be within five to eight percent.

If the acceleration time is longer than expected, and an obvious cause such as low voltage during acceleration can't be found, verify the driven equipment Wk^2 and load, then work with the motor manufacturer to establish the cause of the long acceleration time and its potential impact on successful starting:

- When the motor is satisfactorily up to speed, check operation of the motor as was done when operating uncoupled, and check operation of the driven load.
- When checks are satisfactory, gradually increase load to maximum or desired level, checking unit for satisfactory operation.
- If vibration changes after the units have been operating loaded, in a manner to indicate misalignment of shafts, the shaft alignment may have changed due to differential thermal expansion of the motor or driven load, or of the bases the units are mounted on. If this occurs, a hot alignment check should be made, as follows:
 1. Operate unit at normal load until constant temperature is reached which will take several hours.
 2. Shut down motor and lock out.
 3. Immediately check the horizontal, vertical, and angular shaft alignment.
 4. Adjust shims under motor feet as necessary to bring shafts back into alignment.

If possible, start the motor at various times throughout the day to see the effects of different load demands. Keep in mind that if your factory is not fully operational, these conditions may change later. Successful starting is very sensitive to voltage variations caused by power demands, especially when the load torques and motor torques are with 15% of each other. On motors which are starting across the line with standard load as defined by NEMA this would normally not be as great a concern.

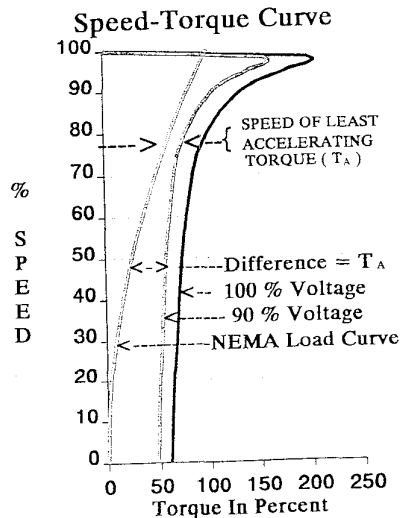

Figure 12
Load Curves
and
Load Torques

Monitor the load current for a couple of days along with the air inlet temperatures. Place temperature detectors directly on the air inlets. This is to make sure there are no unexpected hot air pockets or air recirculation from the exhaust to the intake. Also, record the room ambient temperature, along with the outside ambient temperature. Determine how changes in these temperatures, for the hottest days of the year, would affect the air inlet temperature to the motor. Remember the air inlet temperatures must not exceed the design temperature, usually 40°C. Do not average the inlet temperatures from end to end since it only requires excessive heat on one end of the motor to cause a catastrophic failure.

After the unit has been in operation for approximately a week and operation is satisfactory, the motor should be doweled to its mounting surface.

Doweling the motor feet accomplishes:

1. Restricts movement.
2. Eases realignment if motor is removed from its base.
3. Temporarily restrains the motor, if the mounting bolts loosen.

Recommended procedure for doweling is as follows:

1. Check shaft alignment. If there is any doubt that it is satisfactory, correct as necessary.

2. Using pre-drilled dowel holes in the motor feet as guides, drill into the mounting base.
3. Ream the holes in the feet and base to the proper diameter for tapered dowel pins. Clean out the chips.
4. Insert dowel pins.

The motor is now ready for long and satisfactory service. A suggestion is to start a log of the motor and driven unit, entering significant data at 1 to 3 month intervals, if it is readily obtainable, such as: load, volts, amps, RPM, bearing temperatures, stator temperatures, vibration, running hours, number of starts, maintenance performed - such as regreasing bearings or adding oil, etc. The log will be valuable if problems develop later.

Preventative Maintenance

Machines are designed and built to give many years of reliable service with a minimum of attention. However, proper maintenance is necessary to attain trouble-free service. Some items of preventative maintenance are described here.

A definite schedule of preventative maintenance should be established for each motor. This can be part of the recommended log to be started for each motor when it is installed.

Each motor should be inspected at regular intervals. The frequency and thoroughness will depend on the operating hours, nature of service, environment around the motor, and any previous problems.

The exterior should be kept free of oil, dirt, and chemicals. It is particularly important to keep the air intake and exhaust openings free of obstructions, so as not to block air or force recirculation of hot exhaust air back into the motor's air intake openings. The interior ventilating passages may be blocked if large particles, such as sawdust, are in the air and enter the motor. This will cause the motor to overheat, because the cooling air cannot circulate through the interior passages of the rotor and stator. Likewise, if the motor is equipped with filters, they should be kept clean, so as not to block cooling air from entering the machine. An easy and useful check that can be done daily is to feel the flow and temperature of exhaust air from the machine, and investigate further if the air flow doesn't feel right. If the motor is equipped with stator temperature detectors, a change in temperature will also tell if air flow is partially blocked, or exhaust air being recirculated back into the motor's air intakes.

Slight changes of vibration are normal with changing ambient and load conditions, such as from winter to summer. Larger vibration changes may warn of coming problems, including such things as loose parts, shifting or loose base or foundation, misalignment of shafts at coupling, low oil level or grease level in bearings, bearing problems, or driven equipment problems.

Any change of vibration which is more than "slight" should be investigated.

The bearings absolutely require preventative maintenance, and, if neglected, can lead to an early and disappointing failure. Both anti-friction and sleeve bearings require care on a scheduled basis.

Anti-friction bearing arrangements are engineered for long life, often with an L10 life exceeding 100,000 hours - 11.4 years. What an L10 life means is that, on a statistical basis, in clean and planned operating conditions, 90% of the bearings will exceed the L10 life, and 50% will exceed 5 times the L10 life. However, many times the "clean and planned" conditions are not present. Lubricating grease becomes dirty, or the grease loses a significant portion of the oil which the base retains - due to high temperature, or mixing incompatible types of grease in a bearing, causing the base to soften, etc. - or abrasive particles or water works through the seals to contaminate the grease. For these reasons grease lubricated anti-friction bearings need to be relubricated periodically.

The definition of "periodically" depends on the type, size, speed, load, temperature, and expected length of time cleanliness of the grease remains or how soon the grease will be contaminated sufficiently that it needs to be replaced in the bearing with fresh grease. Most motors have information recommending regreasing cycles, based on hours of operation in a relatively clean environment. A typical tabulation of recommended regreasing cycles is shown in Figure 13.

	Motor Speed	Shaft Ext. Diameter	Relubrication Frequency (Whichever comes first)	
			Months	Operating Time
Direct Connect	3600 or 3000	Under 3.0"	4	2000 Hours
		3.0" & Over	4	1000 Hours
	1800 or Less	4.0" & Under	6	3000 Hours
		Over 4.0"	6	1500 Hours
Belted	1800 or 1500	4.0" & Under	3	1500 Hours
		Over 4.0"	3	750 Hours
	1200 or 1000	All	3	1500 Hours
		All	6	3000 Hours

Figure 13

Manufacturers choose a specific grease for the initial lubrication of bearings based on stability, tolerance of expected operating temperatures, moisture resistance, etc. Much has been written about compatibility of various types of grease

when regreasing bearings, and opinions don't always agree. It is normally not recommended to mix greases of different bases. The best procedure is to consult the grease supplier with specific questions. A note here to allay the fears of some is useful. When motors are built, often the manufacturer will pack the grease into anti-friction bearings directly, during assembly. Later the tubes and tips for regreasing are assembled. Thus, motors are very often received with no grease in the regreasing inlet and outlet openings, even though the bearings have the correct amount of grease.

It is very important to regrease bearings periodically, to remove life-shortening contaminants from the bearings.

Sleeve bearings likewise need preventative maintenance. The most important is to check the oil level regularly, preferably daily, to be sure it is at the specified oil level mark. If the operation of oil rings is considered, it is easy to realize that there isn't a lot of tolerance in the oil level for ring oiled bearings. Oil rings lubricate well if the inside diameter of the ring is approximately 10 to 15% immersed in oil in the oil reservoir of the bearing. For a typical three inch diameter bearing, the oil rings would have a 5 and 1/2 inch to 6 inch inside diameter. Considering that 15% of 5 3/4 inches is .86 inches, the tolerance for the oil level is approximately plus or minus one-quarter inch. The oil level should then be maintained in this range. Too high an oil level will create excessive foam in the oil reservoir, which may lead to oil leaks through the shaft seals. Too low an oil level may reduce the oil delivery to the bearing surface, leading to hot bearings, vibration, and eventual failure.

At the first sign of oil discoloration or contamination, replace with new oil. Rapid discoloration is caused by bearing wear, often from vibration or thrust. Change oil as required to keep clean, using the oil type and viscosity specified for the motor. A typical lubricating oil specification is shown in figure 14.

Recommended Grades of Turbine Oil		
Motor RPM	Oil Viscosity at 100°F	ISO Grade
3600 or 3000	140 - 160 SSU	32
1800 & slower	275 - 350 SSU	68

Figure 14

Oil ring operation should be checked frequently, and can be observed through the sight glass mounted for this purpose at the top of the bearing capsule. Oil rings should be turning at a constant speed and carry a noticeable amount of oil to the top of the journal. Failure of the oil ring to turn freely can be caused by:

1. Ring out of round - should be round with 1/16 inch
2. Rings out of balance
3. Fouling on a projection of the bearing bushing
4. Adhesion to side of opening in bearing bushing

5. Oil too cold or viscous
6. Shaft not level - oil ring tends to bind or drag on side of bushing

On machines having space heaters, operation should be checked on a regular schedule to be sure they are operating properly, to keep the winding dry when the motor isn't operating.

The insulation resistance of the winding should be checked at one or two year intervals, or more often if a problem is suspected. Either a hand cranked or battery operated solid state insulation resistance tester is the most convenient device to use. Refer to the standard of the Institute of Electrical and Electronic Engineers (IEEE) No. 43 (8) for the testing of insulation resistance. Very briefly, the publication recommends that stator winding insulation resistance (at 40°C) measured with 500 volts dc after one minute, should not be less than:

$$\frac{\text{Rated voltage} + 1000}{1000} = \text{Resistance in Megohms}$$

Most new form wound machines would exceed 10,000 megohms and most random wound machines would exceed 500 megohms. This formula is satisfactory for most checks. These should not have changed significantly from the original measurement. If they did, the cause should be determined and evaluated.

CONCLUSION

Successful motor operation includes: Choosing the proper motor, proper installation, proper monitoring, and proper maintenance. Failure to do any one of these, can lead to an early failure. When these tasks are performed adequately, a long life and few problems can be expected.

References

- (1) R.R. Burke, "Maintenance Program Spots, Corrects Machine Vibration," Electrical World, June 27, 1966
- (2) W.R. Finley, "Noise in Induction Motors - Causes and Treatments," IAS, 1991, IEEE Transactions of Industry Applications, 1991, Volume 27, Number 6
- (3) Bearing Installation and Maintenance Guide, SKF USA, Inc., February 1992
- (4) W.R. Finley and R.R. Burke, "Trouble Shooting Motor Problems", IAS, 1993, IEEE Transactions of Industry Applications, 1994, Volume 30, Number 5.
- (5) NEMA MG1-1993, Motors and Generators
- (6) ANSI CR 50.41
- (7) IEEE 85 IEEE Standard Test Procedure for Airborne Sound Measurements
- (8) IEEE Standard 43-1974, Recommended Practice for Testing Insulation Resistance of Rotating Machinery