

# Power sources

## Power sources

Whether you need to run your parts once a day or 24 hours a day, Enerpac has the power source to help you get the job done. Power sources range from simple manual pumps to air operated, to fully customizable electric motor driven units.

With a wide variety of accessories to choose from, Enerpac power units are easily the most versatile and reliable in the industry.



















## Technical support

Refer to the “Yellow Pages” of this catalog for:

- Safety instructions
- Basic hydraulic information
- Advanced hydraulic technology
- FMS (Flexible Machining Systems) technology
- Conversion charts and hydraulic symbols.

 197 ▶

	▼ series	▼ page	
<b>Choosing a Pump</b>		<b>96 - 97</b>	
<b>Turbo II air-hydraulic pumps</b>	<b>PA</b>	<b>98 - 101</b>	
<b>Air-hydraulic pumps</b>	<b>ZAJ</b>	<b>102</b>	
<b>Air-hydraulic pumps</b>	<b>PA</b>	<b>103</b>	
<b>Air-hydraulic boosters</b>	<b>AHB, B</b>	<b>104 - 105</b>	
<b>Air valves and accessories</b>	<b>VA, VR RFL</b>	<b>106 - 107</b>	
<b>Economy electric pumps</b>	<b>WU</b>	<b>108 - 109</b>	
<b>Electric submerged pumps</b>	<b>WE</b>	<b>110 - 113</b>	
<b>Z-Class Electric pumps</b>	<b>ZW</b>	<b>114 - 117</b>	
<b>Return line filter kit and heat exchanger kits</b>	<b>ZPF, ZHE</b>	<b>118 - 119</b>	
<b>Level/temperature switch and pressure transducer</b>	<b>ZLS ZPT, ZPS</b>	<b>120</b>	
<b>Valve manifolds</b>	<b>ZW</b>	<b>121</b>	
<b>Pallet coupling pumps</b>	<b>ZW</b>	<b>122 - 123</b>	
<b>Continuous connection pumps</b>	<b>ZW</b>	<b>124 - 125</b>	
<b>Single station D03 pumps</b>	<b>ZW</b>	<b>126 - 127</b>	
<b>Electric driven workholding pump</b>	<b>ZW5</b>	<b>128 - 131</b>	
<b>Hand pumps</b>	<b>P, SP</b>	<b>132</b>	
<b>Enerpac system solutions</b>		<b>133</b>	

# Choosing a pump

Flow rate: 0,08 - 8,7 l/min

Pressure: 65 - 700 bar

Reservoir: Up to 40 liters

## Options

### Manual valves



☞ 143, 148-151 ▶

### Electric valves



☞ 136-142 ▶

### Air operated valves



☞ 140 ▶

## Important

1 in<sup>3</sup> = 16,387 cm<sup>3</sup>

1 cm<sup>3</sup> = 0,061 in<sup>3</sup>

1 dm<sup>3</sup> = 1 litre = 61,02 in<sup>3</sup>

1 US gal = 3,785 litres

## Select your pump type

### Air operated pump

Best choice for medium circuits with intermittent or medium duty applications. Air operated pumps have lower flow rates than electric pumps, but are more economical.

☞ 98-103 ▶



### Air hydraulic booster

Best choice for small circuits with intermittent or medium-duty applications. Air hydraulic boosters provide a single shot of oil to your circuit at high pressure.

☞ 104-105 ▶



### Economy electric operated pump

The Economy pump is best suited to power small to medium size fixtures. Its lightweight and compact design makes it ideal for applications which require easy transport of the pump. The universal motor works well on long extension cords.

☞ 108-109 ▶



### Electric submerged pump

Enerpac two stage electric submerged pumps are a quiet, economical workholding power source. Submerged in oil the motor stays cooler when used on an intermittent basis.

☞ 110-113 ▶



### Electric operated pump

Best choice for large circuits with medium or high-duty applications. Electric operated pumps have the highest flow rates available and can be configured with many different accessories.

☞ 114-131 ▶



## Select your pump options

### Reservoir size

Choose a reservoir size that holds enough oil to fill all of your lines, manifolds and cylinders, with enough reserve for future needs. Each Enerpac cylinder has an oil capacity listed on its product page, and each power unit has a reservoir capacity listed.

### Valve type

Directional valves allow you control over what portion of the circuit receives oil. Valves can be operated manually, by electric solenoid or by air pilot pressure. Multiple valves can be used with one power unit to control multiple circuits.

### Accessories

For increased automation, electric pumps can be outfitted with additional accessories, including pressure switches, level switches, and control pendants. These options can either be factory installed or added to an existing power unit in the future.

## Factors to consider when choosing a pump

- ? Is an air or electric pump preferred
- ? How frequently will the pump cycle
- ? Are there size constraints where the pump would be mounted
- ? What is the oil volume of the clamps actuated together in each group
- ? Is there an accumulator? What is the oil volume
- ? Are there sequence valves? What is the setting of the first one
- ? Are the control valves to be controlled by the machine controller

- Flow rate: 0,08 - 8,7 l/min
- Pressure: 65 - 700 bar
- Reservoir: up to 40 liters

## Enerpac Workholding Pump Comparison Chart

### What oil flow is right for you?

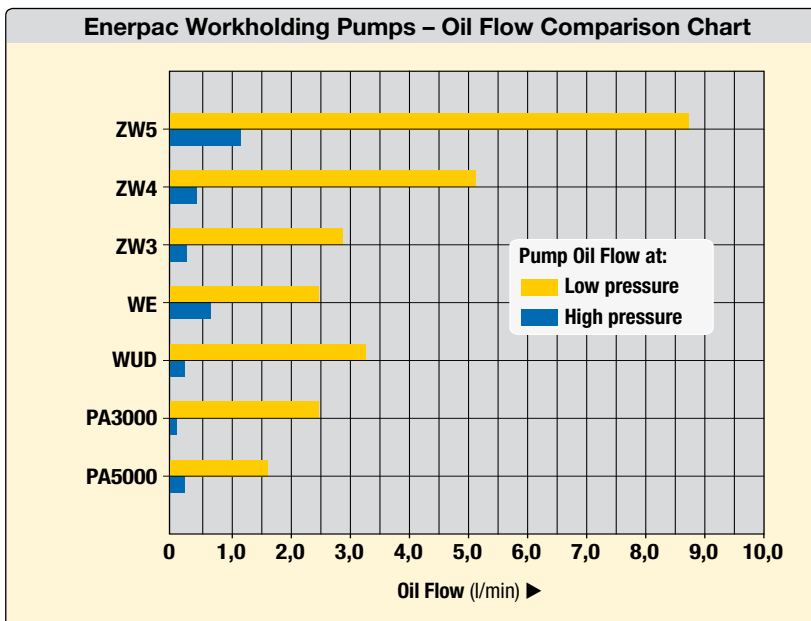

Type of pump	Oil flow at low pressure (l/min)	Oil flow at high pressure (l/min)
ZW5-Series	8,74	1,64
ZW4-Series	5,19	0,82
ZW3-Series	2,80	0,54
WE-Series Submerged	2,45	0,65
WUD-Series Economy	3,28	0,33
Turbo Air PA3000-Series	2,46	0,08
Turbo Air PA5000-Series	1,64	0,33

# Turbo II air-hydraulic pumps *Application & selection*

Shown: PAMG-5402NB, PACG-3102NB, PATG-3102NB, PATG-5105NB



**▶** Turbo II air hydraulic pumps generate the hydraulic pressure you need using the air pressure you have available. The Air Saver Piston reduces air consumption and operating costs.

They are ideal for providing the power and speed desired in simple clamping circuits. Turbo II air-hydraulic pumps are best suited to medium and lower cycle applications. At only 75 dBA, the Turbo II series helps to keep noise level to a minimum.

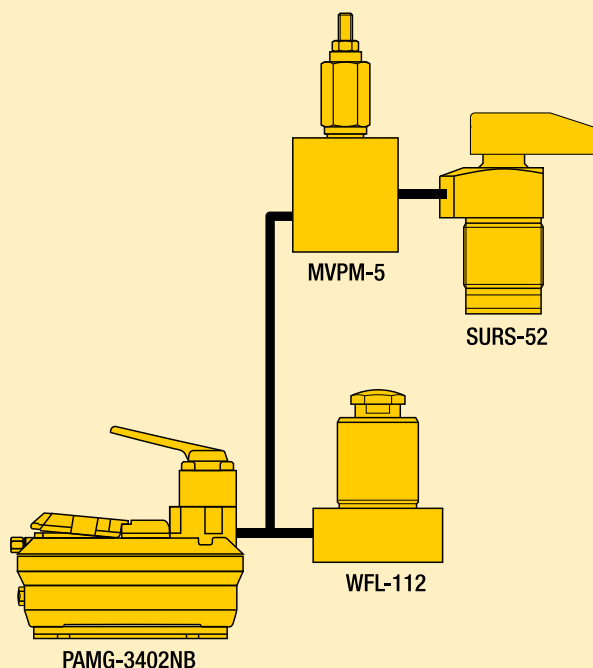

## Quick and powerful hydraulic supply in an economical air-powered unit

- On-demand stall-restart operation maintains system pressure, providing clamping security
- External adjustable pressure relief valve (behind sight glass)
- Internal pressure relief valve provides overload protection
- Reduced noise level to 75 dBA
- Operating air pressure: 4-8,5 bar – enables pump to start at low air pressure\*\*
- Reinforced heavy-duty lightweight reservoir for applications in tough environments
- Five valve mounting options provide flexibility in setup and operation
- Fully serviceable air motor assembly.

## **🌐** Select the required output

### 3000 series

- Hydraulic to air ratio: 45:1

### 5000 series

- Hydraulic to air ratio: 60:1

\*\* NOTE: From 4-8,5 bar air inlet pressure. Performance is significantly diminished below 4 bar. Performance may vary compared to listed values due to seal friction, internal pressure drops and manufacturing tolerances. Be sure to allow some flexibility on air inlet pressure.

## **🌐** Output oil flow vs pressure

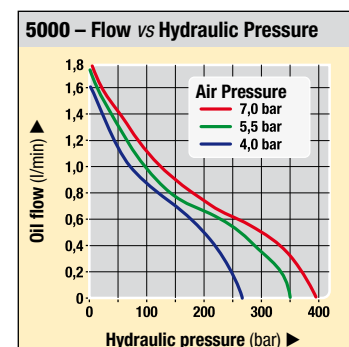
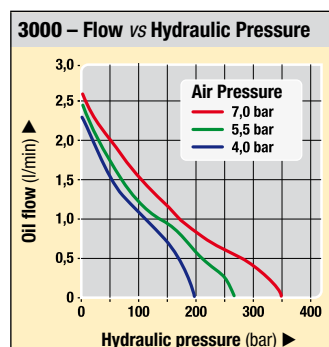

 **Select the required output:**

**PATG series**

- Momentary air inlet treadle for operation of single-acting cylinders
- Provides advance, hold and retract functions.

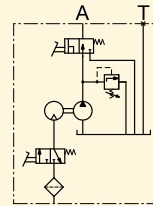

**PACG series**

- Momentary or continuous air inlet treadle
- A remote valve is required for operation of cylinders.

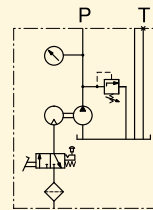

**PASG series**

- Momentary or continuous air inlet treadle
- Suitable for mounting any single- or double-acting valve with a D03 mounting configuration
- Available with multiple valve manifold (7,5 litre only).

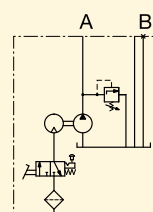

**PAMG series**

- Momentary or continuous air inlet treadle
- Manual 4-way, 3-position, tandem center valve for single- or double-acting operation.

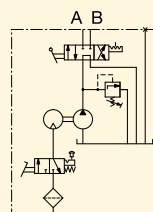

**PARG series**

- Includes 5 m air pendant for remote control of single-acting cylinders
- Provides advance, hold and retract functions.

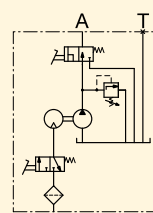

**Oil Flow: 0,08 - 2,46 l/min**

**Pressure: 350 bar**

**Air: 340 l/min**

**Reservoir: 1,1 - 5,0 litres**

- E** Bombas hidroneumáticas
- F** Pompes hydro-pneumatiques
- D** Lufthydraulische pumpen

 **Options**

**Gauges and accessories**

 190 ▶



**Regulator-filter-lubricator**

 106,158 ▶



 **Important**

**For high cycle applications electric pumps are recommended.**



# PA-series *Dimensions & options*

Shown: PACG30S8S-WM10



## ▶ 1,9 litre Turbo Air Pump

The 1,9 litres Turbo pump models feature a drawn steel reservoir with an oil level sight glass. Choose from models with a P & T manifold for use with remote mount valves, a single station D03 manifold, the standard treadle or manual 4 way valve models. The PARG series uses an air operated pendant to control the pump functions. Or build a system pump with multiple Enerpac VP valve series, VP03 series or VSS/VST series D03 mount valves. The VMMD series D03 Manual valves can also be used.

- 1 Auxiliary vent/tank fill port
- 2 Hydraulic output
- 3 Gauge mounting port
- 4 Swivel air input with filter
- 5 Filtered permanent tank vent
- 6 Adjustable pressure relief valve
- 7 Air pendant air input

## 1,9 litres reservoir (dimensions in mm)

### PATG series

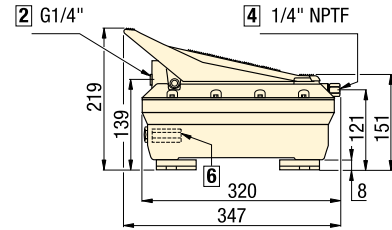
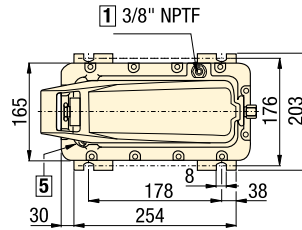

### PACG series

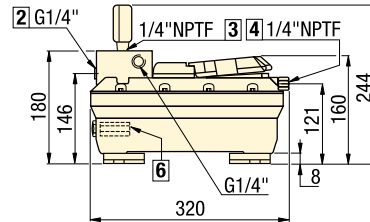
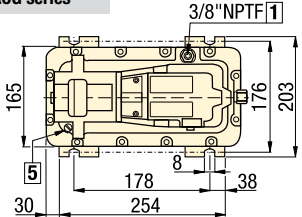

PACG series include pressure gauge G-2517L.

### PASG series

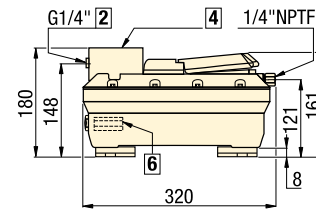
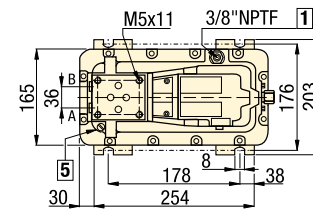

### PAMG series

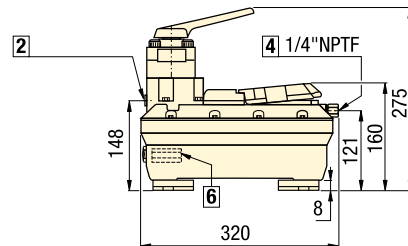
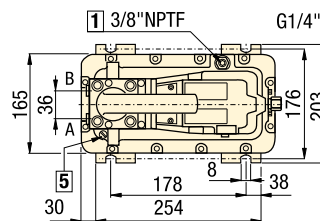

### PARG series

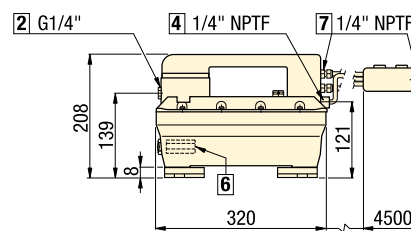
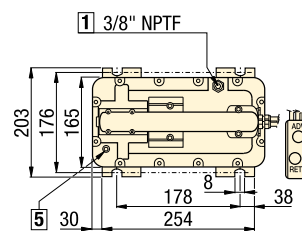

## Product selection

Description	Model numbers 3000 series	Model numbers 5000 series	Usable oil capacity <sup>2)</sup>		Air pressure range	Air consumption	kg
			horizontal mount	vertical mount			
	2,46 l/min <sup>1)</sup>	1,64 l/min <sup>1)</sup>	litres	litres	bar	l/min	
<b>▼ Factory supplied valves</b>							
Hand/foot 3-way	PATG-3102NB	PATG-5102NB	2,1	1,1	1,7 - 8,6	340	8,6
Hand 4-way	PAMG-3402NB	PAMG-5402NB	2,1	1,1	1,7 - 8,6	340	11,3
Remote 3-way pendant	PARG-3102NB	PARG-5102NB	2,1	1,1	1,7 - 8,6	340	10,4
<b>▼ User supplied valves</b>							
Remote mount	PACG-3002SB	PACG-5002SB	2,1	1,1	1,7 - 8,6	340	8,6
Pump mount, single D03 Valve	PASG-3002SB	PASG-5002SB	2,1	1,1	1,7 - 8,6	340	8,6

<sup>1)</sup> At 0 bar hydraulic and 7 bar air pressure.

<sup>2)</sup> Turbo air-hydraulic pumps are also available with 5,0 litres reservoir. To order replace 2 in model number with 5. Sound level: 75 dBA.

**7,5 litres reservoir** (dimensions in mm)

All models

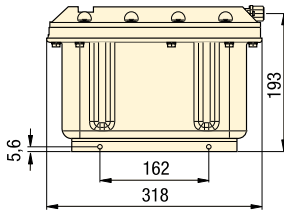

PACG series

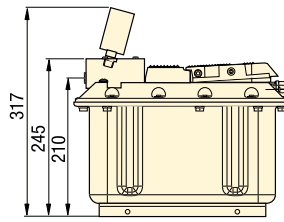

PACG with MB2 or MB4

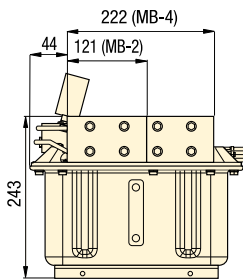

PAMG series

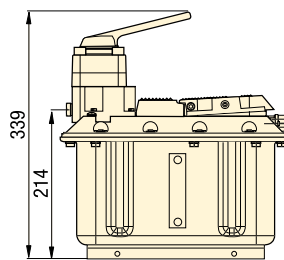

PACG with WM10

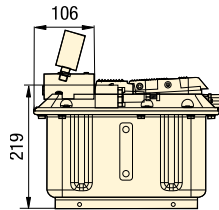

PASG series

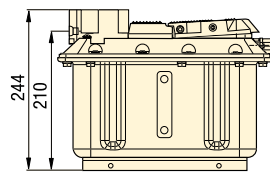
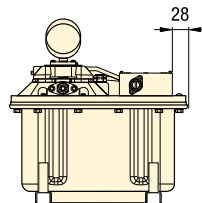

PARG series

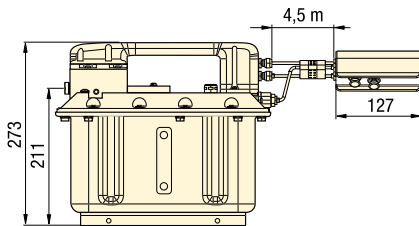

PATG series

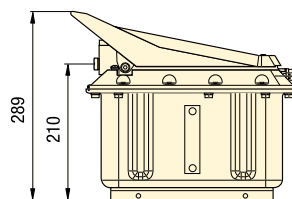

Oil Flow: 0,08 - 2,46 l/min

Pressure: 350 bar

Air: 340 l/min

Reservoir: 1,9 - 7,5 litres

- E** Bombas hidroneumáticas
- F** Pompes hydro-pneumatiques
- D** Lufthydraulische pumpen

**Options**

Gauges and accessories

190 ▶



Regulator-filter-lubricator

106,158 ▶



**Product selection**

Description	Model numbers 3000 series	Model numbers 5000 series	Usable oil capacity	Air pressure range	Air consumption	
	2,46 l/min <sup>1)</sup>	1,64 l/min <sup>1)</sup>	litres	bar	l/min	kg
<b>▼ Factory supplied valves</b>						
Hand/foot 3-way	<b>PATG-31S8N</b>	<b>PATG-51S8N</b>	7,5	1,7 - 8,6	340	24,5
Hand 4-way	<b>PAMG-34S8N</b>	<b>PAMG-54S8N</b>	7,5	1,7 - 8,6	340	27,2
Remote 3-way pendant	<b>PARG-31S8N</b>	<b>PARG-51S8N</b>	7,5	1,7 - 8,6	340	26,3
<b>▼ User supplied valves</b>						
Remote mount	<b>PACG-30S8S</b>	<b>PACG-50S8S</b>	7,5	1,7 - 8,6	340	24,5
Pump mount, Single D03 Valve	<b>PASG-30S8S</b>	<b>PASG-50S8S</b>	7,5	1,7 - 8,6	340	24,5
Pump mount, Two D03 Valves	<b>PACG-30S8S-MB2</b>	<b>PACG-50S8S-MB2</b>	7,5	1,7 - 8,6	340	26,3
Pump mount, Four D03 Valves	<b>PACG-30S8S-MB4</b>	<b>PACG-50S8S-MB4</b>	7,5	1,7 - 8,6	340	27,6
Pump mount, (1-8) VP Valves	<b>PACG-30S8S-WM10</b>	<b>PACG-50S8S-WM10</b>	7,5	1,7 - 8,6	340	25,4

<sup>1)</sup> At 0 bar hydraulic and 7 bar air pressure. Sound level: 75 dBA.



Shown: ZAJ-06505S2C



## ZAJ-series

These heavy-duty air driven pumps are well suited for use in production applications.

Available with a P & T manifold for use with remote mounted VP, VP03, VSS or VST zero leakage class valves, or with either single or dual pump mounted 2-position/3-way normally Closed valves 24 VDC solenoid valves.

## Heavy-duty Air Powered Pump

- Suited for use in production applications
- 3,8 litre steel reservoir with sight glass, mounting flange.

Flow: 2,0 l/min @ 0 bar  
1,0 l/min @ 140 bar

Pressure: 350 bar max.

- Ⓔ Bombas hidroneumáticas
- Ⓕ Pompes hydro-pneumatiques
- Ⓖ Lufthydraulische pumpen

### ZAJ-06505M1

Pressure and tank manifold for use with remote mounted valves.

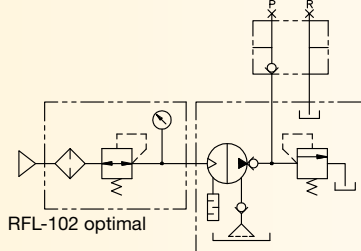

### ZAJ-06505S1C

2-position/3-way normally closed solenoid valve for use with single-acting circuits.

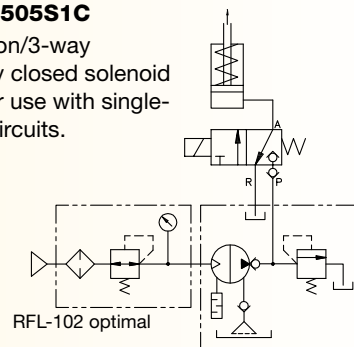

### ZAJ-06505S2C

Dual 2 position/3 way normally closed solenoid valves for use with double-acting circuits.

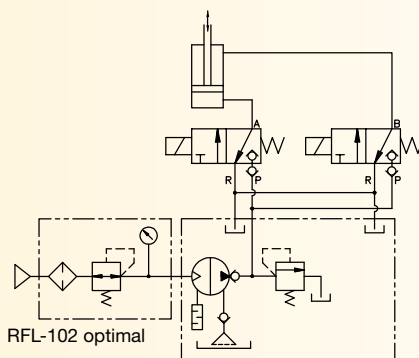

### ZAJ-06505S2C

Dual 2 position/3 way normally closed solenoid valves for use with two independent single-acting circuits.

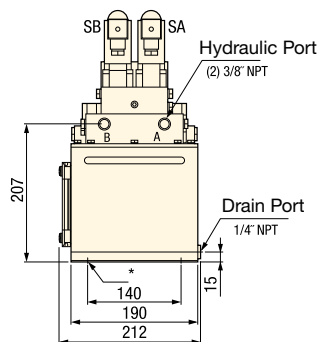
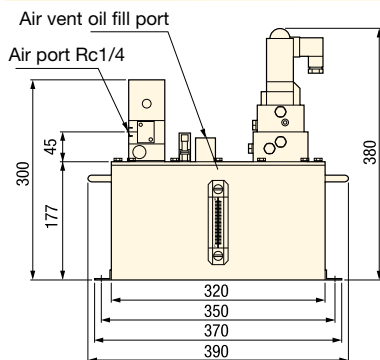
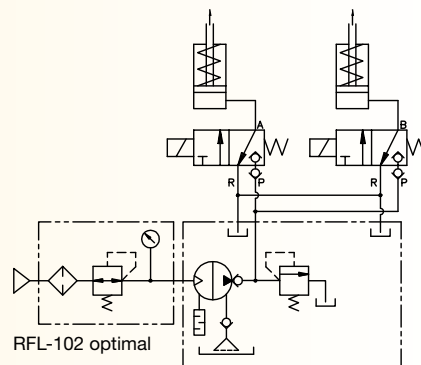

Supplied valving	Valve solenoid voltage	Model number	Air pressure range bar	Oil ports NPTF	Air consumption l/min	kg
Pressure and tank manifold	–	<b>ZAJ-06505M1</b>	1,0 - 6,9	3/8"	510	22,2
Single 2 pos./3 way solenoid valve	24 VDC	<b>ZAJ-06505S1C</b>	1,0 - 6,9	3/8"	510	22,2
Dual 2 pos./3 way solenoid valve	24 VDC	<b>ZAJ-06505S2C</b>	1,0 - 6,9	3/8"	510	22,2

Max. flow: 0,98 - 1,97 l/min

Pressure: 210 - 350 bar

Air: 255 l/min

Reservoir: 0,6 litres

- E** Bombas hidroneumáticas
- F** Pompes hydro-pneumatiques
- D** Lufthydraulische pumpen

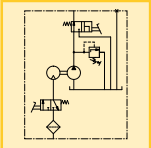

## Portable air hydraulic power

- Patented air saver design - minimal air usage for lower cost operation
- Quiet internal air muffler 80 dBA
- 360° swivel oil and air fittings for easier system setup
- External adjustable relief valve
- Built-in 3-way, 2-position valve provides advance-retract cycle operation for single-acting cylinders.

Shown: PA-135, -136



### ▶ PA-series

Compact, lightweight, air driven power source. Treadle start on pump activates pump operation. Best choice for single-acting cylinders.

### Options

Regulator-filter-lubricator



106,158 ▶

Fittings



194 ▶

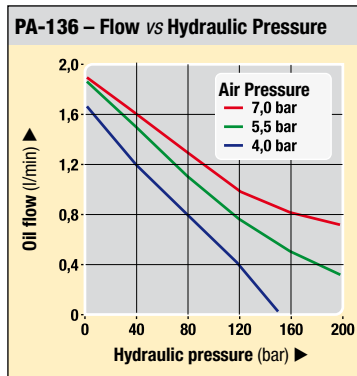
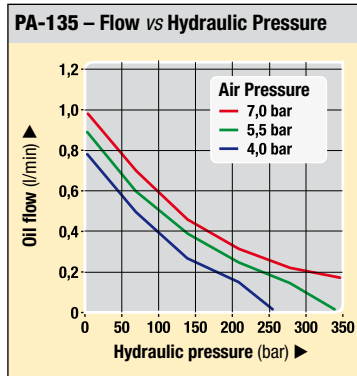
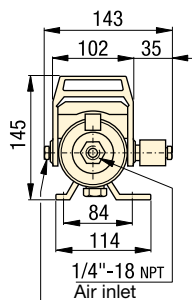
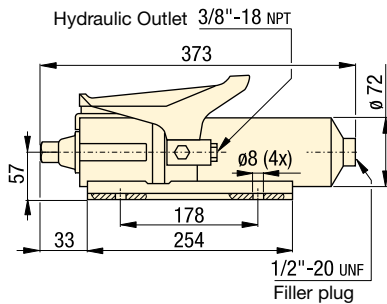

■ These PA series air hydraulic pumps operate in all positions. Here, a PA-135 is mounted vertically to a clamping fixture.



### Product selection

Usable oil capacity	Max. oil flow <sup>1)</sup>	Max. hydraulic pressure	Model number	Valve function	Air pressure range	Air consumption	kg
					bar	l/min	
litres	l/min	bar			bar	l/min	
0,6	0,98	350	<b>PA-135</b>	Advance/Retract	4,1 - 6,9	255	6,5
0,6	1,97	210	<b>PA-136</b>	Advance/Retract	4,1 - 6,9	255	6,5

<sup>1)</sup> At 0 bar hydraulic pressure.

Note: Seal material: Buna-N, Teflon, Polyurethane.

[www.enerpacwh.com](http://www.enerpacwh.com)

# Air hydraulic boosters *Application & selection*

Shown: AHB-46, B-5003, B-3006



## AHB and B-series boosters

Large effective area of air piston allows compressed air to generate high output hydraulic pressure.

## For high production applications

- High speed operation
- Extended service life
- Constant hydraulic output
- Large oil delivery per stroke allows quick filling of cylinders for clamping or punching

### AHB series boosters

- Fiberglass wound air chamber eliminates possibility of rust due to moisture in air system
- Designed for fully automated production applications
- Double-acting, one-shot, high speed operation of air piston

### B series boosters

- One-shot spring return
- Steel and cast iron construction
- Built-in stroke sensor for automatic cycle operation  
30 VDC switch closes 25 mm before end of full air piston stroke
- Internal self-bleeding  
Automatically purges air from system when booster piston is at highest point in circuit

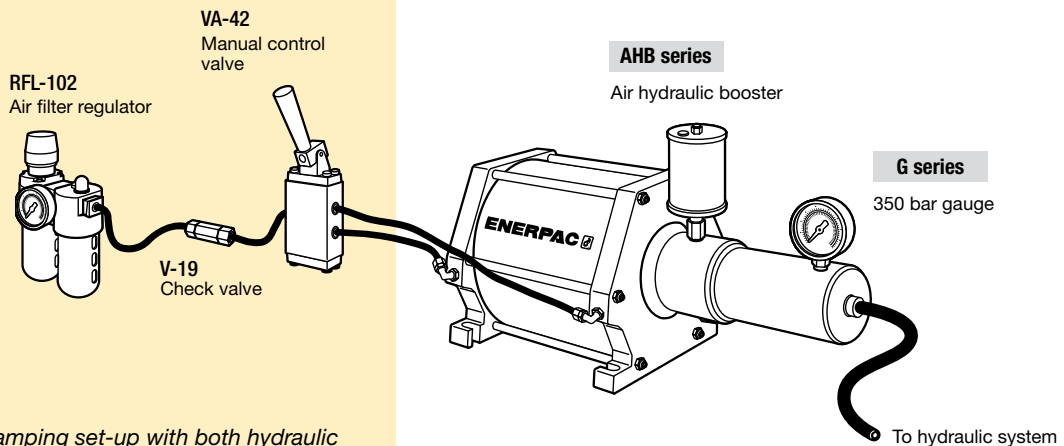

■ In an automated clamping set-up with both hydraulic and pneumatic components, AHB series boosters are used as a power source for the hydraulic system.



## Hydraulic system schematics

Complete power systems eliminate the guesswork of selecting valves and other system components. Plug in your 1 to 8 bar shop air line and connect your hydraulic components for a total system.

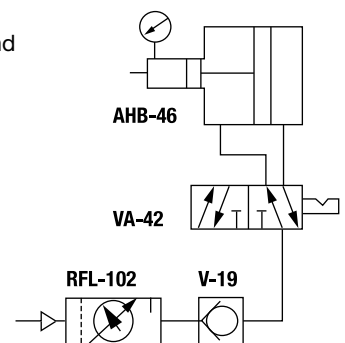

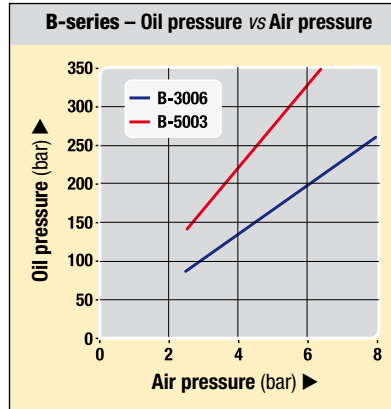
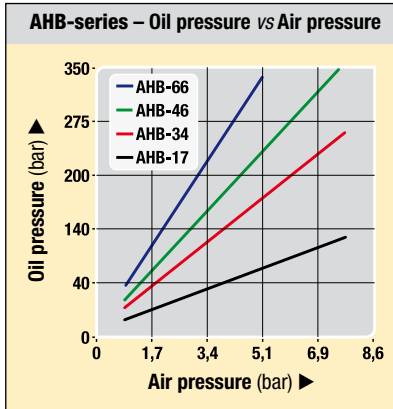

- Ratio: 1:16 - 1:64
- Pressure: 100 - 350 bar
- Oil flow: 60-295 cm<sup>3</sup>/stroke
- Air: 27 - 64 dm<sup>3</sup>/cycle

- E** Multiplicadores
- F** Multiplicateurs
- D** Druckübersetzer

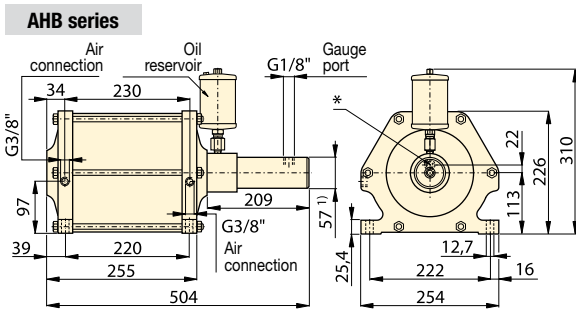
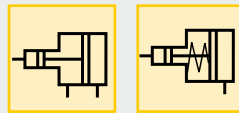

<sup>1)</sup> Ø 72 mm for model **AHB-17**  
 \* Oil connection (G1/4")  
 \*\*\* Adapter to 3/8" NPT air connection is included.  
 NOTE: FZ-2060 Adaptor available for gauge port.

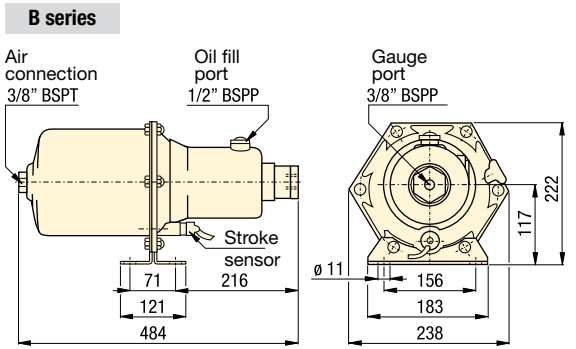

**Options**

- Air valves**  
 106,158 ▶
- Regulator-filter-lubricator**  
 106,158 ▶
- Fittings**  
 194 ▶

**Important**

**Boosters can provide high oil flow rates based on the volume of in-coming air. Do not exceed the flow rate requirements of the components being used.**

**For vertical mounting of booster, an elbow fitting is recommended for the oil reservoir.**

**Selection chart**

Oil pressure bar		Oil volume per stroke cm <sup>3</sup>	Air to oil pressure ratio	Model number	Air consumption per cycle <sup>1)</sup> dm <sup>3</sup> at 6 bar air	Air piston diameter mm	Hydraulic piston diameter mm	Hydraulic stroke mm	Air operating pressure bar	 kg
at 5 bar air pressure	at 7 bar air pressure									
<b>▼ AHB series</b>										
83	110	295,0	1:16	<b>AHB-17</b>	62,6	203	51	145	1-8	18,8
175	235	139,3	1:34	<b>AHB-34</b>	63,6	203	35	145	1-8	16,8
240	315	100,0	1:46	<b>AHB-46</b>	63,9	203	30	145	1-8	16,4
330	-	73,7	1:64	<b>AHB-66</b>	64,1	203	25	145	1-5	16,0
<b>▼ B series</b>										
155	210	101,6	1:30	<b>B-3006</b>	27	180	31	132	3-9	14,0
260	350	60,6	1:50	<b>B-5003</b>	27	180	24	132	3-9	14,0

<sup>1)</sup> One cycle = advance + retract stroke.  
 Note: Seal material: Buna-N, Polyurethane.

Power Sources Valves Pallet Components System Components Yellow Pages

Shown: VA-42, VAS-42



## Air valves

Enerpac's line of directional air valves and accessories complete your workholding system. Used to control air operated hydraulic units, they increase your productivity and efficiency.

### Application

VA-series directional air valves provide either manual or electric control to air operated hydraulic units. Accessories such as rapid exhaust, check valves, silencers and regulators complete the air control system.

- Accessory valves provide greater safety and more efficient clamping cycles
- Recommended for use with all air powered units
- Directional valves to control booster and pump air supply
- Remote air valve permits either hand or foot operation.

## Important

**Valving help**  
See Basic System Set-up and Valve information in our "Yellow Pages".

## To control and regulate air supply

### VA-42 Manual operated air valve 5-way, 2-position

- For control of boosters
- Viton seals standard

### VAS-42 Solenoid operated air valve 5-way, 2-position

- For control of pump and boosters air supply
- Viton seals standard
- Solenoid: 120 VAC, 50/60Hz  
Amperage: inrush 0,11 Amps, holding 0,07 Amps
- Maximum cycle rate: 600 cycles per minute

### VR-3 Rapid exhaust valve

- Enables booster to advance and retract faster
- Instantly exhaust air supply from booster to atmosphere

### V-19 Air check valve

- Prevent rapid drop of air pressure to the booster in the event of sudden loss of input air

### RFL-102 Regulator-Filter-Lubricator

- Regulates air pressure
- Filter air input
- Lubricates air motors with a fine oil vapor mist
- Maximum air flow 1500 l/min

### HV-1000A Air pilot holding valve

- Holds fluid under pressure offering independent control of different branches of the same fixture
- Valve can control the pilot air and the booster in sequence
- Max. oil flow 5 l/min
- Works with the VA-42 four-way air valve and a booster

### QE-375 Muffler

- Use with VR-3 or VAS/VA-42
- Reduces noise level of exhaust air from pump.

## Product selection

Maximum pressure bar	Model number
<b>▼ Air valves</b>	
2-10	VA-42
2-10	VAS-42
0-7	VR-3
0-7	V-19
<b>▼ Holding Valve</b>	
0-7	HV-1000A*
<b>▼ Accessories</b>	
0-8,6	RFL-102
0-8,6	QE-375

\* Maximum hydraulic pressure: 207 bar.

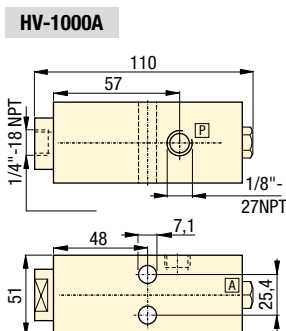
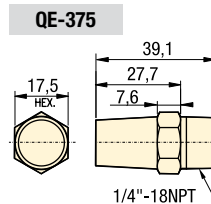
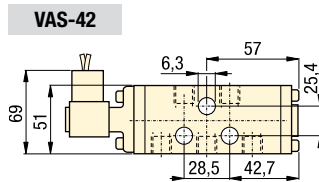
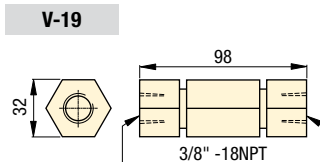
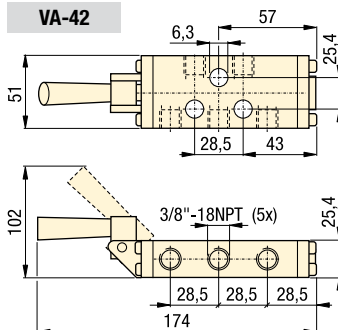
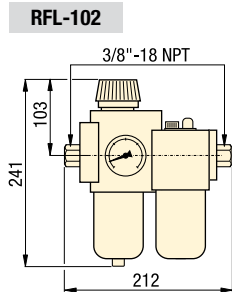
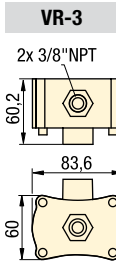
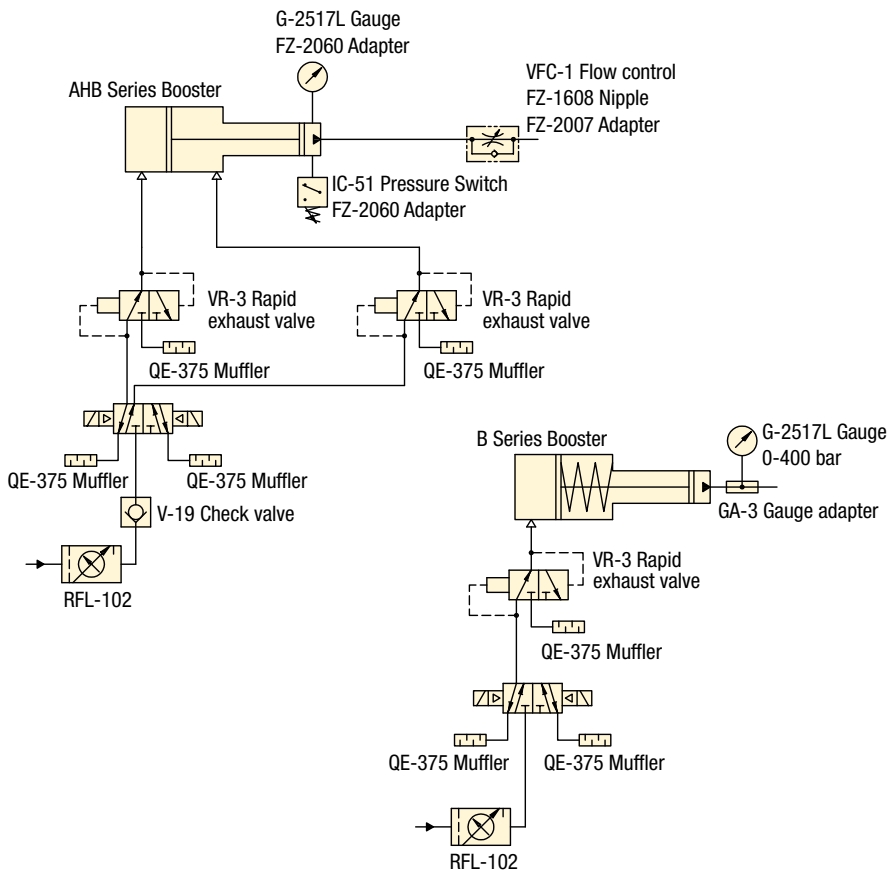

**Air Pressure: 0 - 10 bar**

**E** Válvulas de aire

**F** Valves à air

**D** Luftventile

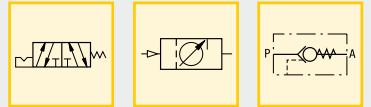

**Options**

**Gauges and adaptors**

190 ▶



**Hoses**

192 ▶



**Fittings**

194 ▶



**Important**

**Valving help**  
See Basic System Set-up and Valve information in our "Yellow Pages".

197 ▶

Shown: WUD-1301E



## WU-series

The Economy pump is best suited to power small to medium size fixtures. Its lightweight and compact design makes it ideal for applications which require easy transport of the pump. The universal motor works well on long extension cords.

## Heavy on performance, light on weight

- Lightweight and compact design, 12 kg
- Large easy-carry handle for maximum portability
- Two-speed operation reduces cycle times for improved productivity
- 115 VAC 50/60- or 220 VAC 50/60-cycle universal motor will operate on voltage as low as 60 volts
- 24 VDC remote motor control, 3 meters for operator safety
- Starts under full load
- High strength molded shroud with integral handle, protects motor from contamination and damage
- Designed for intermittent duty cycle.

### WUD-1100 series

- Provides advance/auto-retract of single-acting cylinders
- 3 meters pendant controls motor and valve operation
- Use with AP-500 accumulator coupler package.

### WUD-1300 series

- Provides advance/hold/retract of single-acting cylinders
- 3 meters pendant controls motor and valve operation
- Ideal for applications requiring remote valve operation
- Use with ACBS-22 or ACBS-202 accumulator coupler packages.

## Product selection

Model number	Used with cylinder	Pressure rating bar	
		1st stage	2nd stage
WUD-1100B	single-acting	14	350
WUD-1101B	single-acting	14	350
WUD-1100E	single-acting	14	350
WUD-1101E	single-acting	14	350
WUD-1300B	single-acting	14	350
WUD-1301B	single-acting	14	350
WUD-1300E	single-acting	14	350
WUD-1301E	single-acting	14	350

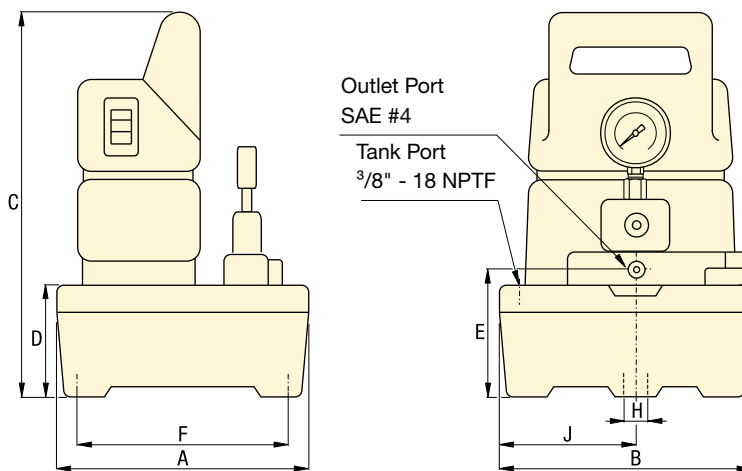
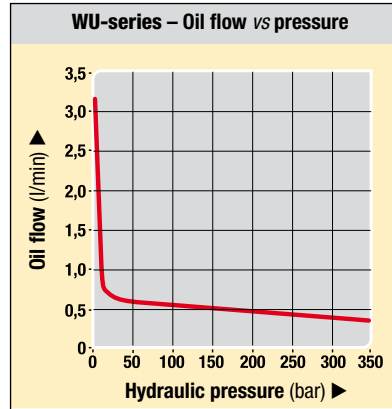

**Product dimensions in mm** [ ]

Usable oil capacity	Model number	A	B	C	D	E	F	H	J	
1,9	<b>WUD-1100B</b>	244	244	362	102	120	203	10	133	11,8
3,8	<b>WUD-1100B</b>	368	309	374	105	130	324	10	143	15,9
1,9	<b>WUD-1100E</b>	244	244	362	102	120	203	10	133	11,8
3,8	<b>WUD-1100E</b>	368	309	374	105	130	324	10	143	15,9
1,9	<b>WUD-1300B</b>	244	244	362	102	120	203	10	133	11,8
3,8	<b>WUD-1300B</b>	368	309	374	105	130	324	10	143	15,9
1,9	<b>WUD-1300E</b>	244	244	362	102	120	203	10	133	11,8
3,8	<b>WUD-1300E</b>	368	309	374	105	130	324	10	143	15,9

	Output flow rate		Valve type	Current draw	Motor voltage	Sound level	Model number
	1st stage	2nd stage					
	3,28	0,33	Dump*	9,5	115	85	<b>WUD-1100B</b>
	3,28	0,33	Dump*	9,5	115	85	<b>WUD-1101B</b>
	3,28	0,33	Dump*	3,2	230	85	<b>WUD-1100E</b>
	3,28	0,33	Dump*	3,2	230	85	<b>WUD-1101E</b>
	3,28	0,33	Dump and Hold	9,5	115	85	<b>WUD-1300B</b>
	3,28	0,33	Dump and Hold	9,5	115	85	<b>WUD-1301B</b>
	3,28	0,33	Dump and Hold	3,2	230	85	<b>WUD-1300E</b>
	3,28	0,33	Dump and Hold	3,2	230	85	<b>WUD-1301E</b>

\* Electric dump valve for auto-retract of cylinders.

- Flow: 0,33 l/min**
- Pressure: 350 bar max**
- Motor: 0,37 kW**
- Reservoir: 1,9 - 3,8 litres**

- E Bombas eléctricas**
- F Centrale hydraulique**
- D Tauchpumpe**

**Standard equipment**

**Gauge, filter and pressure switch**

Pumps are supplied with a manifold mounted 400 bar gauge for convenient reading of pump pressure.

A filter at the pressure port helps to protect the pump from contamination.

A manifold mounted adjustable pressure switch provides control of the pump shut-off pressure.

**Options**

- G-series pressure gauges** [190](#)
- Hoses** [192](#)
- FZ-series fittings** [194](#)
- HF-series hydraulic oil** [193](#)

Power Sources

Valves

Pallet Components

System Components

Yellow Pages



# Electric submerged pumps

Shown: WEM-1401E



## WE-series

Enerpac two stage electric submerged pumps are a quiet, economical workholding power source. Submerged in oil the motor stays cooler when used on an intermittent basis.

## Best performance for mid-range cylinders

- Reduce cycle times for improved productivity
- Two-speed pump unit provides rapid cylinder advance
- Submerged dual voltage induction motor, runs cooler and quieter (60-70 dBA)
- Available with heat exchanger for higher duty cycle applications
- Externally adjustable relief valve – no need to open pump when reducing pressure
- Reservoir mounting holes for easy mounting to fixed surface
- Full length side tube for easy monitoring of oil level
- Auxiliary return port, eliminates the need for a separate adapter.

## Select your pump type

### WED-series with dump valve

- For use when load holding is not required
- Ideal for palletized workholding for single acting circuits
- Motor is on only during work cycle.



### WEJ-series with remote jog

- Manual valve control
- Motor can be turned on and off by remote pendant for jogging capability.



### WEM-series with manual valve

- Manual valve control
- Manual motor control
- Simple and economical solution to your workholding power source needs.



### WER-series with remote actuated solenoid

- Solenoid directional with shear seal design
- Remote valve operation.

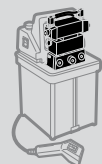

### WES, WET-series with pressure switch \*

- Pressure switch turns motor on and off
- Used when pressure must be maintained over a period of time
- With pressure gauge.



\* Pressure switch specifications: Classification NEMA 1  
Pressure range: IC-51: 207-517 bar  
IC-31: 35-241 bar.

Flow: 0,65 l/min

Pressure: 350 bar max

Motor: 0,37 kW

Reservoir: 5,7 litres

**E** Bombas eléctricas

**F** Centrale hydraulique

**D** Tauchpumpe

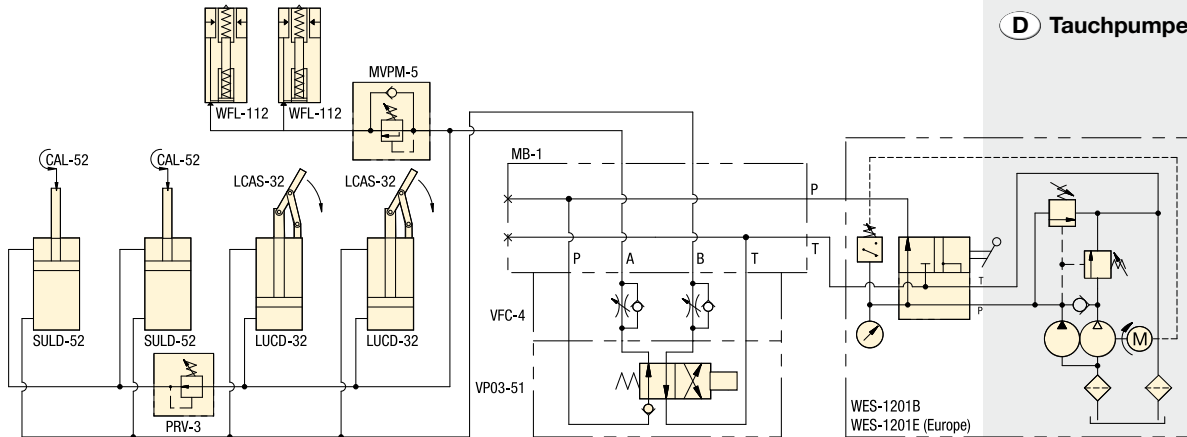
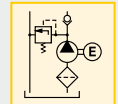

Used with cylinder	Valve function	Valve type	Model number	Motor voltage 50/60 Hz	Heat exchanger
Single-Acting	Advance / Retract	Dump	<b>WED-1101B</b>	115V	
Single-Acting	Advance / Retract	Dump	<b>WED-1101E</b>	230V	
Single-Acting	Advance / Retract	Jog	<b>WEJ-1201B</b>	115V	
Single-Acting	Adv. / Hold / Retr.	Jog	<b>WEJ-1301B</b>	115V	
Double-Acting	Adv. / Hold / Retr.	Jog	<b>WEJ-1401B</b>	115V	
Single-Acting	Advance / Retract	Manual 3/2	<b>WEM-1201B</b>	115V	
Single-Acting	Advance / Retract	Manual 3/2	<b>WEM-1201D</b>	115V	●
Single-Acting	Advance / Retract	Manual 3/2	<b>WEM-1201E</b>	230V	
Single-Acting	Advance / Retract	Manual 3/2	<b>WEM-1201F</b>	230V	●
Single-Acting	Adv. / Hold / Retr.	Manual 3/3	<b>WEM-1301B</b>	115V	
Single-Acting	Adv. / Hold / Retr.	Manual 3/3	<b>WEM-1301F</b>	230V	●
Double-Acting	Adv. / Hold / Retr.	Manual 4/3	<b>WEM-1401D</b>	115V	●
Double-Acting	Adv. / Hold / Retr.	Manual 4/3	<b>WEM-1401E</b>	230V	
Single-Acting	Adv. / Hold / Retr.	Solenoid	<b>WER-1301B</b>	115V	
Single-Acting	Adv. / Hold / Retr.	Solenoid	<b>WER-1301D</b>	115V	●
Single-Acting	Adv. / Hold / Retr.	Solenoid	<b>WER-1301E</b>	230V	
Double-Acting	Adv. / Hold / Retr.	Solenoid	<b>WER-1401B</b>	115V	
Double-Acting	Adv. / Hold / Retr.	Solenoid	<b>WER-1401D</b>	115V	●
Double-Acting	Adv. / Hold / Retr.	Solenoid	<b>WER-1401F</b>	230V	●
Single-Acting	Advance / Retract	Manual 3/2	<b>WES-1201B</b>	115V	
Single-Acting	Advance / Retract	Manual 3/2	<b>WET-1201B</b>	115V	
Single-Acting	Adv. / Hold / Retr.	Manual 3/3	<b>WES-1301B</b>	115V	
Single-Acting	Adv. / Hold / Retr.	Manual 3/3	<b>WES-1301E</b>	230V	
Double-Acting	Adv. / Hold / Retr.	Manual 4/3	<b>WES-1401B</b>	115V	
Double-Acting	Adv. / Hold / Retr.	Manual 4/3	<b>WES-1401E</b>	230V	

## Options

**G-series pressure gauges**

190 ▶



**FL-series high-pressure filters**

193 ▶



**FZ-series fittings**

194 ▶



**HF-series hydraulic oil**

193 ▶



## Important

Oil should be replaced every 500 working hours to ensure long life. Change filters when changing oil or 4 times a year whichever comes first.

Heat exchanger cools oil in pumps used in higher duty cycle applications.

Output flow rate should be matched to hydraulic components used in the system.

# WE-series, Submerged Electric Pumps

Shown: WEM-1401E



## WER series

Enerpac submersed motor pumps are available in a wide range of configurations to fit any requirement.

◀ For full features see page 110.

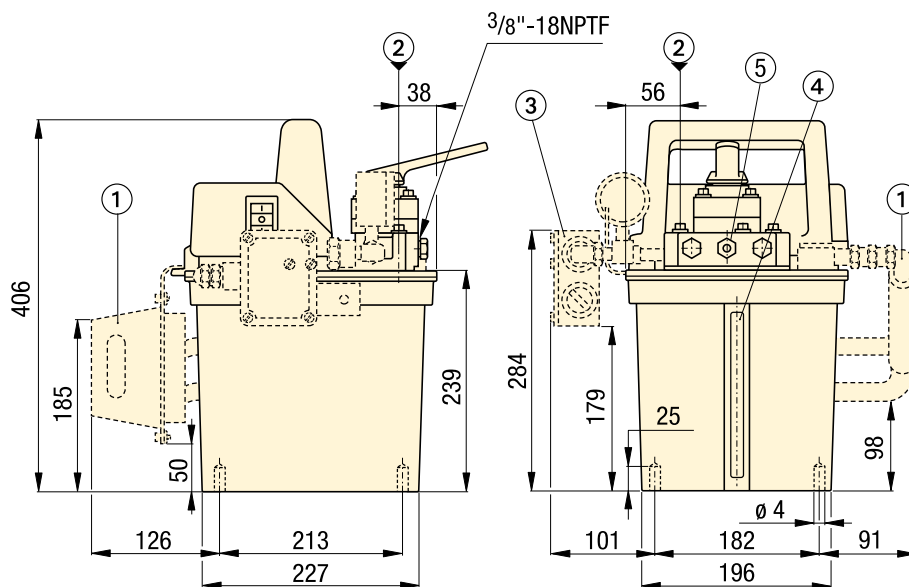
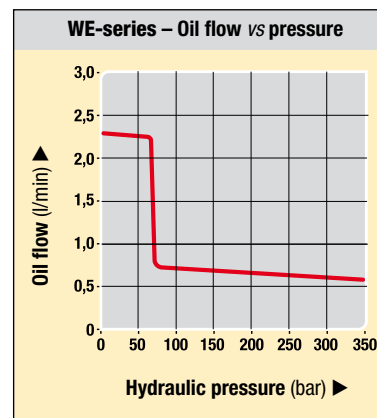

Dimensions shown in mm.

- ① Heat Exchanger (optional for all models)
- ② Fill Port
- ③ Pressure Switch (WES-Series, optional for other models)
- ④ Oil Level Indicator
- ⑤ Adjustable Relief Valve

## Product selection

Motor voltage	Motor capacity	Amperage draw	Maximum oil flow**		Pressure rating		Usable oil capacity	Adjustable relief valve	Weight
			1st stage	2nd stage	1st stage	2nd stage			
50/60 Hz	kW	Amps	1st stage	2nd stage	1st stage	2nd stage	litres	bar	kg
115V-1ph	0,37	13,5	2,45	0,65	70	350	5,5	70 - 350	29 <sup>1)</sup>
230V-1ph	0,37	6,75	2,45	0,65	70	350	5,5	70 - 350	29 <sup>1)</sup>

<sup>1)</sup> Weight for WES and WET models is 37 kg.

\*\* All flow data at 50 Hz.

## Custom build your submerged pump

### ▼ This is how a submerged pump model number is built up:

If the submerged pump that would best fit your application cannot be found in the chart on page 111, you can easily build your custom submerged pump here.



#### 1 Product Type

W = Workholding Pump

#### 2 Motor Type

E = Electric motor

#### 3 Pump Type

D = Dump

J = Jog

M = Manual

R = Remote (solenoid)

S = Pressure switch (IC-51)

T = Pressure switch (IC-31)

#### 4 Pump Series

1 = 0,37 kW, 350 bar

#### 5 Valve Type

0 = No valve (WER only)

1 = Dump

2 = 3-way, 2-position, normally open

3 = 3-way, 3-position, tandem center

4 = 4-way, 3-position, tandem center

5 = Custom VE-series valve (WER only)

See example 2 below.

#### 6 Reservoir Capacity

01 = 5,5 litres usable oil

#### 7 Motor Voltage and Heat Exchanger

B = 115 V, 1 Ph, 50/60 Hz

D = 115 V, 1 Ph, 50/60 Hz with heat exchanger

E = 230 V, 1 Ph, 50/60 Hz

F = 230 V, 1 Ph, 50/60 Hz with heat exchanger

I = 230 V, 1 Ph, 60 Hz\*

\* To order WER models, for 60 Hz applications, replace the "E" suffix for "I".

#### Ordering example 1



#### Examples

Model number:  
**WER-1301E**

The **WER-1301E** is a 0,37 kW, 350 bar, submerged electric pump, with 5,5 litres usable oil capacity, a 3-way, 3-position modular, remote solenoid valve (VEF-series) and a 230 V, 1 phase, 50/60 Hz motor.

Model number:  
**WER-1501E- VED11000D**

The **WER-1501E** is a 0,37 kW, 350 bar, submerged electric pump, with 5,5 litres usable oil capacity. The valve, model **VED11000D** is a 24 V, 50 Hz solenoid valve. (For details and options for all VE-series valves see pages 146-147).

Flow: 0,65 l/min

Pressure: 350 bar max

Motor: 0,37 kW

Reservoir: 5,5 litres

**E** Bombas eléctricas

**F** Centrale hydraulique

**D** Tauchpumpe

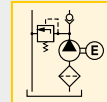

#### Important

**WER series pumps use the VE-series valves shown on page 146. WER-13 series uses VEF-series valve. WER-14 series uses VEC-series valve.**

**WES series pumps use IC-51 pressure switch, adjustable from 210-525 bar**

**WET series pumps use IC-31 pressure switch, adjustable from 35-245 bar.**

Shown: ZW5020HE-FT22



**Z-Class electric pumps are designed for use in the harshest manufacturing environments. The pumps provide reliable and durable performance in a wide variety of configurations.**

## The standard for workholding applications

- Features Z-Class high-efficiency pump design; higher oil flow and by-pass pressure, cooler running and requires 18% less current than comparable pumps
- Totally enclosed, fan cooled industrial electric motors supply extended life and stand up to harsh industrial environments
- Multiple valve and reservoir configurations provide application specific models to match the most demanding workholding applications
- High-strength, molded electrical enclosure protects electronics, power supplies and LCD readout from coolant and contamination.

Collet-Lok® products

Swing clamps

Work Supports

Linear Cylinders

Power Sources

### Basic configurations

All pumps listed in this chart include LCD electrical box, 20 litres reservoir, return line filter and either 0-420 bar pressure gauge or pressure transducer (solenoid valve models). For additional options, see the complete pump matrix on page 117.

### Pump type

### Valve/manifold type

### Motor voltage

50/60 Hz

### ZW-Series with manifold

- Used when supplying pressure to multiple valve circuits
- Valves must be supplied separately.

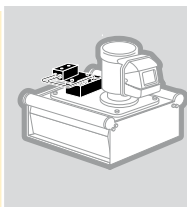

Pressure and tank ports

230 VAC, 3 ph

Single station DO3

230 VAC, 3 ph

Enerpac VP-series

230 VAC, 3 ph

Two station DO3

230 VAC, 3 ph

Four station DO3

230 VAC, 3 ph

### ZW-Series with pallet coupling valve

- Provides momentary pressure and flow to fixture
- Ideal for pallet disconnect systems.

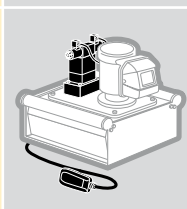

4-way, 3-pos. solenoid operated

115 VAC, 1 ph

4-way, 3-pos. solenoid operated

230 VAC, 3 ph

4-way, 3-pos. solenoid operated

460 VAC, 3 ph

### ZW-Series with continuous connection valve

- Provides solenoid control of one single or double-acting circuit
- Control valve supplied with integrated pilot operated check to ensure positive pressure holding.

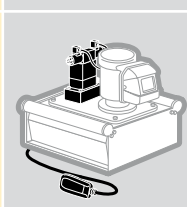

4-way, 3-pos. solenoid operated

115 VAC, 1 ph

4-way, 3-pos. solenoid operated

230 VAC, 3 ph

4-way, 3-pos. solenoid operated

460 VAC, 3 ph

### ZW-Series with manual valve

- Provides manual control of one single or double-acting circuit
- Control valve supplied with center holding function to ensure positive position holding.

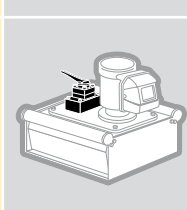

4-way, 3-pos. manually operated

115 VAC, 1 ph

4-way, 3-pos. manually operated

230 VAC, 3 ph

4-way, 3-pos. manually operated

460 VAC, 3 ph

## Output oil flow versus hydraulic pressure

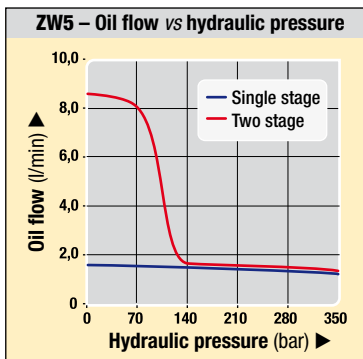
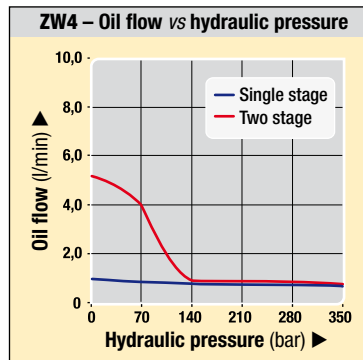
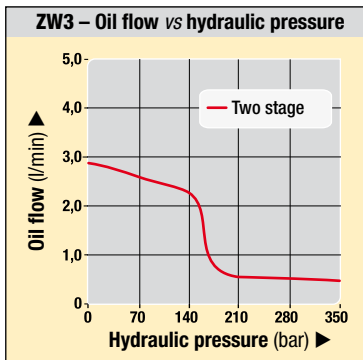

ZW3 Series Output oil flow at 0,54 l/min at 350 bar LCD Electric Model Nr.	ZW4 Series Output oil flow at 0,82 l/min at 350 bar LCD Electric Model Nr.	ZW5 Series Output oil flow at 1,64 l/min at 350 bar LCD Electric Model Nr.
ZW3020HG-FE01	ZW4020HG-FW01	ZW5020HG-FW01
ZW3020HG-FE11	ZW4020HG-FW11	ZW5020HG-FW11
ZW3020HG-FE12	ZW4020HG-FW12	ZW5020HG-FW12
ZW3020HG-FE21	ZW4020HG-FW21	ZW5020HG-FW21
ZW3020HG-FE41	ZW4020HG-FW41	ZW5020HG-FW41
ZW3420DB-FT	ZW4420DB-FT	ZW5420DB-FT
ZW3420DE-FT	ZW4420DE-FT	ZW5420DE-FT
ZW3420DW-FT	ZW4420DW-FT	ZW5420DW-FT
ZW3420FB-FT	ZW4420FB-FT	ZW5420FB-FT
ZW3420FE-FT	ZW4420FE-FT	ZW5420FE-FT
ZW3420FW-FT	ZW4420FW-FT	ZW5420FW-FT
ZW3420LB-FG	ZW4420LB-FG	ZW5420LB-FG
ZW3420LE-FG	ZW4420LE-FG	ZW5420LE-FG
ZW3420LW-FG	ZW4420LW-FG	ZW5420LW-FG

Flow rate: 0,54 - 1,64 l/min

Pressure: 350 bar max

Motor: 0,75 - 1,12 kW

Reservoir: 8 - 40 litres

- E** Bombas eléctricas
- F** Centrale hydraulique
- D** Tauchpumpe

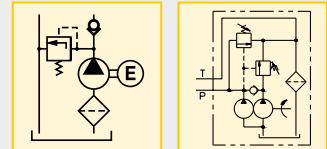

### ! Important

All Z-Class electric pumps are CSA and CE compliant.



LCD electrical package is required for pumps utilizing electric valves, or optional accessories such as the pressure transducer, level switch, pressure switch or heat exchanger.

Single-stage pumps provide constant flow throughout the entire pressure range via a radial piston pump. Two-stage pumps provide high flow via a gear pump until the bypass pressure is reached. At pressures above the bypass setting, the radial piston pump provides flow to the maximum pressure.

# Electric pumps *Dimensions & options*

Shown: ZW5020HE-FT22



## ZW-series

Z-Class electric pumps are designed for use in the harshest manufacturing environments. The pumps provide reliable and durable performance in a wide variety of configurations.

- Efficient design reduces heat generation and reduces power consumption
- Balanced pump section reduces vibration improving durability and sound levels
- Optional back-lit LCD readout provides hour and cycle counts, low voltage warnings and pressure read-out when used with pressure transducer
- Low-voltage pendant on solenoid valve models with sealed switches improves operator safety
- **Z-Class** electric pumps can be supplied with factory installed accessories such as valve manifold, pressure transducer, and return line filter, creating a complete power unit solution.

<b>Flow: 0,54 - 1,64 l/min</b>
<b>Pressure: 350 bar</b>
<b>Motor: 0,75 - 1,12 kW</b>
<b>Reservoir: 8 - 40 litres</b>

- E** Bombas eléctricas
- F** Centrale hydraulique
- D** Tauchpumpe

## Options

### User adjustable relief valve



All ZW-Series have a user adjustable relief valve to allow the operator to easily set the optimum working pressure.

10, 20, 40 litres

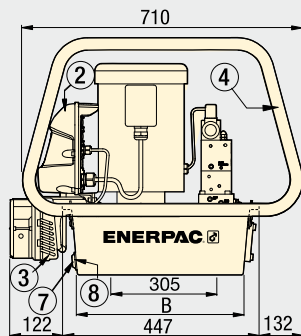

8 litres

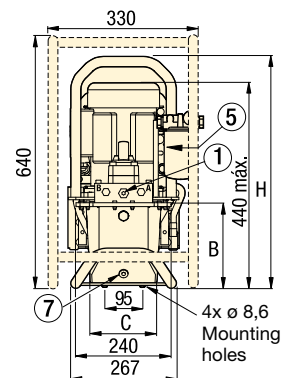
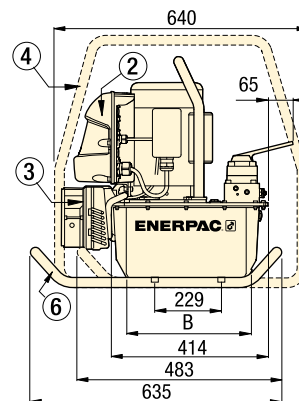
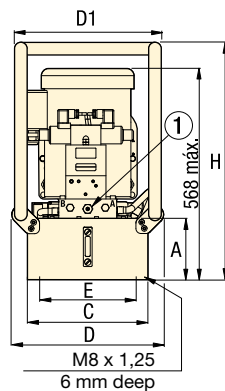

- ① Pump mounted manifold
  - User adjustable relief valve
  - 3/8" NPTF on A and B ports
  - 1/4" NPTF on auxiliary ports
- ② Electric Box (Optional w/manual valve)
- ③ Heat Exchanger (Optional)
- ④ Roll Bar (Optional)
- ⑤ Return Line Filter (Optional)
- ⑥ Skid Bar (Optional)
- ⑦ Oil Drain
- ⑧ Oil Level/Temperature Switch (Optional)

## Product dimensions in mm [ $\text{D} \pm \text{D}$ ]

Usable oil capacity	ZW Series pump dimensions							
	litres	A	B	C	D	D1	E	H
8	206	287	168	-	-	-	-	574
10	155	419	305	384	371	279	599	
20	180	419	422	500	488	396	625	
40	269	399	505	577	572	480	714	

## Product selection

Output flow rate at 50 Hz					Pump series	Motor size	Relief Valve adjustment range	Sound level
(l/min)								
7 bar	50 bar	115 bar	210 bar	350 bar		kW	bar	dBA
2,80	2,68	2,32	0,54	<b>0,54</b>	ZW3 *	0,75	70 - 350	75
5,19	4,17	-	0,86	<b>0,82</b>	ZW4	0,75	70 - 350	75
8,74	8,23	-	1,68	<b>1,64</b>	ZW5	1,12	70 - 350	75

\* Constant flow rate for single-stage models.

# ZW-series, Electric Pump ordering matrix

## Custom build your pump

▼ This is how a ZW-series Model number is built:

<b>Z</b>	<b>W</b>	<b>4</b>	<b>0</b>	<b>20</b>	<b>H</b>	<b>G</b>	<b>- FG</b>	<b>01</b>
1	2	3	4	5	6	7	8	9
Product Type	Motor Type	Flow Group	Valve Type	Usable Oil Capacity	Valve Operation	Voltage	Options <sup>1</sup>	Manifold Options

### 1 Product type

**Z** = Z-Class Pump

### 2 Motor type

**W** = Workholding Electric

### 3 Flow group

**3** = 0,54 l/min

**4** = 0,82 l/min

**5** = 1,64 l/min

### 4 Valve type

**0** = No valve or valve manifold

**2** = 3-way, 2-position, manual valve

**3** = 3-way, 3-position, manual valve

**4** = 4-way, 3-position, manual or solenoid valve

**6** = 3-way, 3-position, tandem center w/P.O. check (manual only)

**8** = 4-way, 3-position, tandem center w/P.O. check (manual only)

### 5 Usable oil capacity

**8** = 8 litres (2 gallon)

**10** = 10 litres (2,5 gallon)

**20** = 20 litres (5 gallon)

**40** = 40 litres (10 gallon)

### 6 Valve operation

**D** = Solenoid valve (pallet coupling) with pendant and LCD (valve type **4**)

**F** = Solenoid valve (continuous connection) with pendant and LCD (valve type **4**)

**G** = Valve manifold without LCD (valve type **0**)

**H** = Valve manifold with LCD (valve type **0**)

**L** = Manual valve with LCD (without pendant, valve type **2, 3, 4, 6** or **8**)

**M** = Manual valve without LCD (valve type **2, 3, 4, 6** or **8**)

**N** = No valve, without LCD (valve type **0**)

**W** = No valve with LCD (valve type **0**)

### 7 Power supply

Single Phase

**B** = 115V, 1 ph, 50-60 Hz<sup>3</sup>

**E** = 208-240V, 1 ph, 50-60 Hz  
European plug

**I** = 208-240V, 1 ph, 50-60 Hz  
USA plug

Three Phase

**M** = 190-200V, 3 ph, 50/60 Hz

**G** = 208-240V, 3 ph, 50/60 Hz

**W** = 380-415V, 3 ph, 50/60 Hz

**K** = 440V, 3 ph, 50/60 Hz

**J** = 460-480V, 3 ph, 50/60 Hz

**R** = 575V, 3 ph, 50/60 Hz

### 8 Options<sup>2</sup>

**F** = Return line filter, 25 micron

**G** = 0-420 bar pressure gauge, 63,5 mm<sup>5</sup>

**H** = Heat exchanger<sup>4</sup>

**L** = Level/temperature switch<sup>4</sup>

**N** = No handles (lifting eyes only)<sup>2</sup>

**P** = Pressure switch<sup>4</sup>

**R** = Roll bars

**S** = Single stage

**T** = Pressure transducer<sup>4</sup>

**U** = Foot switch<sup>4</sup>

### 9 Manifold options<sup>5</sup> (Pump types G and H only)

**01** = Pressure & tank porting manifold

**11** = Single station D03

**12** = VP series manifold

**13** = Single station CETOP

**21** = 2 station D03

**22** = 2 station CETOP

**41** = 4 station D03

**42** = 4 station CETOP

<sup>1</sup> Options should be specified in alphabetical order.

<sup>2</sup> Unless specified, all pumps are supplied with reservoir handles.

<sup>3</sup> 115 volt pumps are supplied with CE and CSA approved 15 Amp plug for intermittent use. 20 Amps circuit recommended for frequent full pressure use.

<sup>4</sup> These options require LCD electrical package.

<sup>5</sup> Pressure gauge not available on pump models with pressure transducer. Pressure transducer provides digital pressure readout on LCD display.

<sup>6</sup> Pressure switch option is only used as input to a customer control. It is not used with the LCD electrical package.

## Example

The **ZW5810LG-FT** is a 1,64 l/min, 2-stage pump with a manual 4-way, 3 position tandem center valve, integrated P.O. check, LCD electrical box, 10 litres reservoir, 208-240 volt 3-phase motor, return line filter and pressure transducer.

Flow: 0,54 - 1,64 l/min

Pressure: 350 bar

Motor: 0,75 - 1,12 kW

Reservoir: 8 - 40 litres

**E** Bombas eléctricas

**F** Centrale hydraulique

**D** Modulare Spannumppe

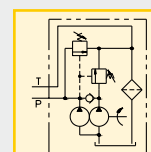
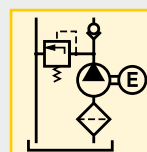

## Example

**ZW4020GE-FGS21** is a 0,82 l/min, single-stage pump with a 2 station D03 manifold, standard electric without LCD, 20 litres reservoir, 230 volt, 50/60 Hz motor, return line filter and 0-420 bar pressure gauge.

**ZW4410DW-T** is a 0,82 l/min, 2-stage pump with a pallet de-coupling valve, LCD electrical box, 10 litres reservoir, 380-415 volt 3-phase motor and pressure transducer.

**ZW5040HG-FGL01** is a 1,64 l/min, 2-stage pump with a pressure and tank manifold, LCD electrical box, 40 litres reservoir, 230 Volt 3-phase motor, return line filter, 0-420 bar pressure gauge and level and temperature shutdown switch.



Shown: ZPF



## ZPF series

The oil filter kit removes contaminants from the return oil flow before allowing it back into the reservoir, reducing component damage.

## Extend life of hydraulic components

...increase system reliability

- 25 micron nominal filter cleans oil to increase system life
- Internal bypass valve to prevent damage if the filter is dirty
- All installation components included
- Kit assembles quickly and easily to Enerpac pump and manifold
- Maintenance indicator included

Filtration: 25 micron

Pressure: max. 13,8 bar

Max. flow: 45,4 l/min

(E) Filtro

(F) Filtre

(D) Filter

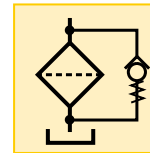

## Options

PF-25 replacement filter element



For best performance, replace filter element on a regular basis. Change filters when changing oil or four times a year, whichever comes first.

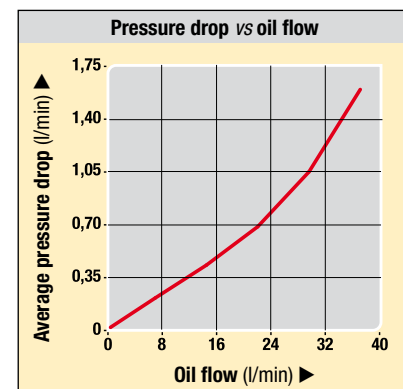

## Product selection

Nominal filtration	Model number	Maximum pressure	Maximum oil flow	Bypass pressure setting	Filter gauge service indicator	kg
micron		bar	l/min	bar		
25	ZPF	13,8	45,4	1,7	●	1,5

Transfer: 900 Btu/h

Pressure: max. 21 bar

Voltage: 24V

- (E) Intercambiador de calor
- (F) Échangeur de chaleur
- (D) Wärmetauscher

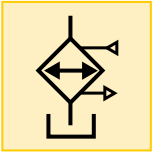

## Extends system life

- Electrical connector factory installed
- All installation components included
- Stabilizes oil temperature at a maximum of 54° C at 21° C ambient temperature
- Stabilizes oil viscosity, increasing oil life and reduces wear of pump and other hydraulic components

Shown: ZHE-E10



### ZHE series

Heat exchanger removes heat from the return oil to provide cooler operation.

### Important

#### ZHE- Series Heat Exchangers

Heat exchanger stabilizes oil temperature at 54° C at 21° C ambient temperature.

Thermal transfer at 19 l/min and 21° C ambient temperature: 900 Btu/hour.

**Do not exceed maximum oil flow of 26,5 l/min and maximum pressure of 20,7 bar. Not suitable for water-glycol or high water based fluids.**

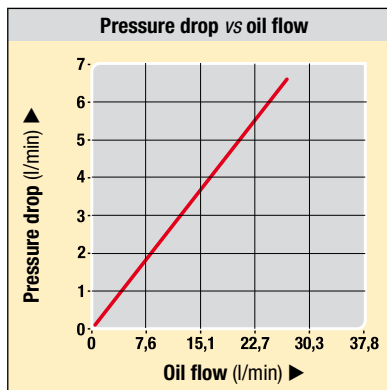

## Product selection

Voltage	Model number	Thermal transfer*	Amperage draw	Maximum pressure	Maximum oil flow	Weight
VDC		Btu/h kJoule	A	bar	l/min	kg
24	<b>ZHE-E10</b>	900 950	0,95	21	26,5	4,0

\*At 1,9/min and ambient temperature of 21° C.

Shown: ZLS-U4



## ZLS series

Oil level indicator for pump reservoir. If the pump is mounted in a remote area that does not provide visual access to the external oil level sight glass, the level/temp switch will turn off the pump before internal damage can occur due to cavitations.

## Electronic level/temperature switch for feedback on pump oil level

- Drop-in design allows for easy installation to pump reservoir
- Electrical connector included
- Built-in thermal sensing provides feedback on oil temperature
- Senses low oil level in pump reservoir.

Temp. set point: 80° C

Voltage: 24 VDC

- (E) Indicador del nivel/temp.
- (F) Interrupteur de niveau/temp.
- (D) Ölstand/Temperaturschalter



## Product Selection

Fixed temperature signal	Model number	Voltage	Thermostat rating setting	Maximum pressure	
°C		VDC	Amps	bar	kg
80	<b>ZLS-U4</b>	24	2,6	10	0,05

Shown: ZPT-U4, ZPS-W4



## ZPT-series

ZPT pressure transducer provides constant pressure monitoring for automated pump control.

## ZPS-series

ZPS pressure switch can be used to provide a pressure signal to an external control.

## Control your pump, monitor pressure

### ZPT pressure transducer

- More durable than analog gauges (against mechanical and hydraulic shock)
- More accurate than analog gauges (0,5% full scale)
- Calibration can be fine tuned for certification
- "Auto-mode" provides automatic pressure make-up
- Display pressure in psi, bar or MPa

Pressure: 3,5 - 700 bar

Voltage: 115 VAC / 24 VDC

- (E) Presión transductor
- (F) Pressostats
- (D) Druckschalter

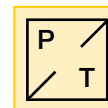
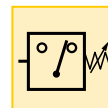

### ZPS pressure switch

- Includes glycerin filled gauge, G2536L
- Can be used to provide pressure input to customer provided controls
- Not to be used with LCD control
- For pressure based input to the LCD control, use the ZPT-U4 transducer.

## Product Selection

Adjustable pressure range	Electrical specification	Model number	Accuracy (full scale)	Deadband	
bar				bar	kg
3,5 - 700	4-20 mA	<b>ZPT-U4</b>	0,5 %	3,5	0,13
35 - 700	115 VAC /24 VDC N.O.	<b>ZPS-W4</b>	2,0 %	8 - 40	1,22

Note: Electrical harness included with kit. ZPS-W4 includes 0-420 bar pressure gauge.

## Important

The pressure transducer is factory installed in the "A" port on pumps supplied with valves, and in the "P" port on models with manifolds.

**Pressure: 350 bar**

**Stations: 1-4 valves horizontal**

**Stations: 1-8 valves vertical**

- E** Colectores
- F** Manifolds
- D** Verkettingsblöcke

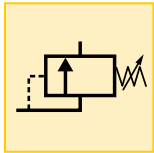

## Increased flexibility for complex systems

- Manifolds provide hydraulic connection to remote or pump mounted valves
- Used when multiple valves are required for controlling several independent circuits
- Available for 2 and 4 station DO3 as well as Enerpac VP series mounting
- Pressure and tank porting manifold available for use with remote valve sticks
- Manifolds include integrated relief valve for system pressure control.

Shown: MB-2, -4



### ▶ MB series

Manifolds allow the use of multiple valves powered by a single hydraulic pump. Manifolds are available factory installed on your Z-Class workholding power unit, or separately for future system upgrades.

**Option 01**

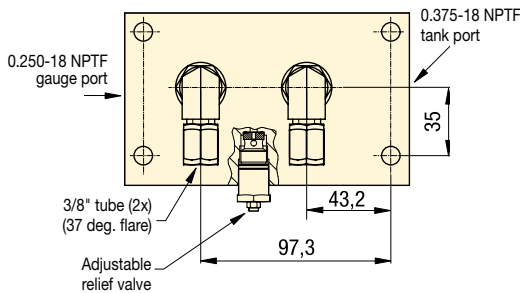

**Option 12**

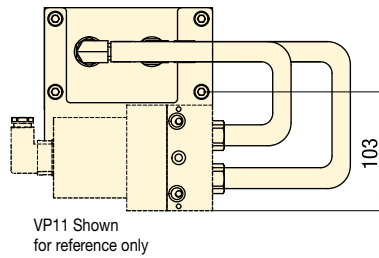

**Option 21, 41**

VMMD-001 Shown for reference only

Option 21 has two valve stations  
 Option 41 has four valve stations

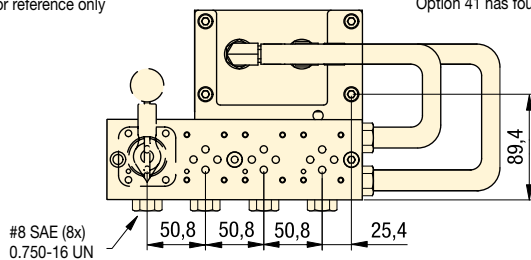

## Product Selection

Valve mounting pattern	Option code (see page 117)	Number of stations	Coverplate model number
Porting manifold, SAE ports	<b>01</b>	-	-
Enerpac VP Series	<b>12</b>	1-8	-
2 station DO3	<b>21</b>	2	MC-1
4 station DO3	<b>41</b>	4	MC-1
2 station CETOP3	<b>22</b>	2	MC-3
4 station CETOP3	<b>42</b>	4	MC-3

## Options

**Pressure transducer**

120 ▶



**Level switch**

120 ▶



■ *Enerpac porting manifold provides pressure and tank line to remote mounted valve stack on a machining center.*



# Pallet coupling pumps *Application & selection*

Shown: ZW4420FE-FT



▶ The new Enerpac Pallet Coupling Pump provides three modes of operation:

### Manual mode

Pump runs as long as operator holds down pendant button.

### AUTO mode without timer

Pump runs until user-adjustable pressure setting is reached.

### AUTO mode with timer

Pump runs until pressure setting is reached, and adjustable timer runs out.

■ ZW5410FE-FT used to connect and disconnect a palletized fixture.



## Automatic pressure control for palletized fixtures

- Programmable clamp and unclamp pressure settings increase automation capability
- Programmable dwell settings ensure desired pressure level is maintained on large circuits or circuits with accumulators
- Remote pendant features sealed switches for improved operator safety
- Backlit LCD provides pump usage information, hour and cycle counts.

## Example Circuits

- Double-acting circuit

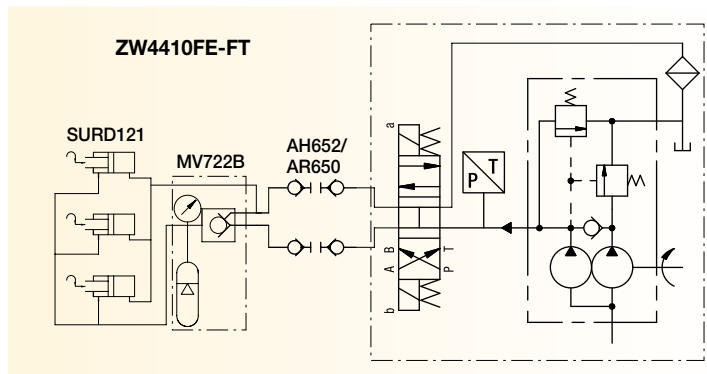

- Single-acting circuit

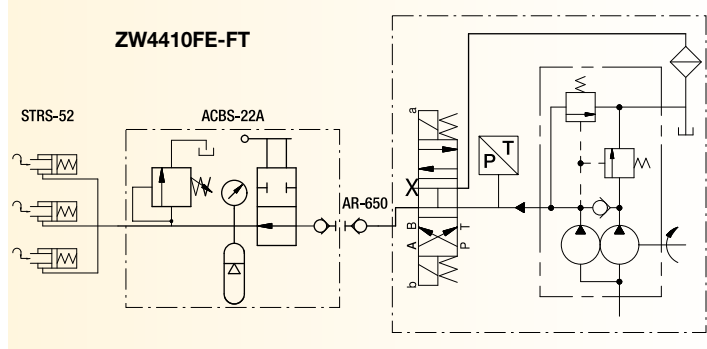

## Product selection

Flow rate @ max. pressure	Motor size	Motor voltage	Model number	Pressure range	Sound level	Usable oil capacity	
l/min	kW	V-ph-Hz		bar	dBA	litres	kg
0,54	0,75	115-1-50	ZW3408DB-FT	70-350	75	8	52
		115-1-50	ZW3410DB-FT			10	61
		230-1-50	ZW3408DE-FT			8	52
		230-1-50	ZW3410DE-FT			10	61
0,82	0,75	115-1-50	ZW4410DB-FT	70-350	75	10	54
		230-1-50	ZW4410DE-FT				
		400-3-50	ZW4410DW-FT				
1,64	1,12	115-1-50	ZW5410DB-FT	70-350	75	10	58
		230-1-50	ZW5410DE-FT				
		400-3-50	ZW5410DW-FT				

## **i** Operation – pallet coupling pump

### Manual mode

Motor and pump operate only when operator presses and holds the up (or down) arrow on the pendant. When button is released, pressure in the hoses is relieved.

### AUTO mode

*With DWELL timer set equal to zero:* operator starts the motor by pressing and holding the up (or down) arrow on the pendant. Pump builds to pressure on the clamp (or unclamp) circuit until it reaches customer programmed setting. The motor immediately turns off and pressure in the hoses is relieved.

*With DWELL timer set greater than zero:* operator starts the motor by pressing the up (or down) arrow on the pendant. Once the pump reaches the programmed setting, the DWELL timer starts. When the timer runs out, the motor stops and pressure in the hoses is relieved.

Flow: 0,54 - 1,64 l/min

Pressure: 350 bar

Motor: 0,75 - 1,12 kW

Reservoir: 8,0 - 40,0 litres

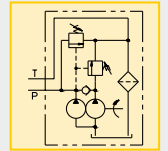
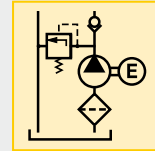

## **g** Output oil flow versus hydraulic pressure

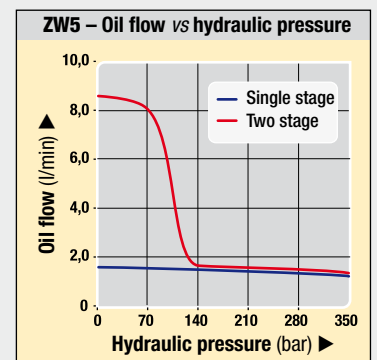
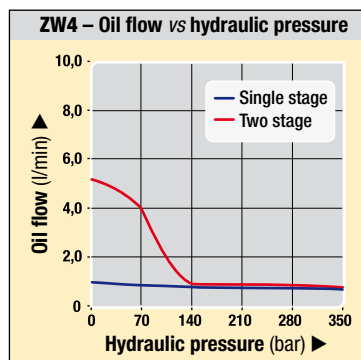
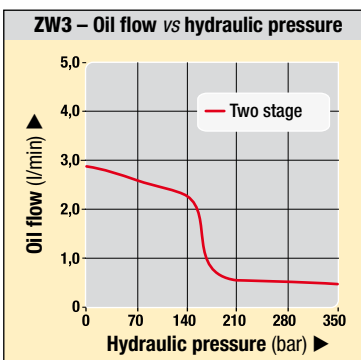

10, 20, 40 litres

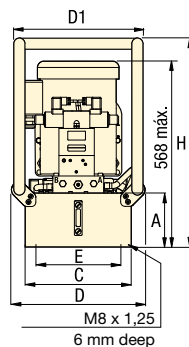
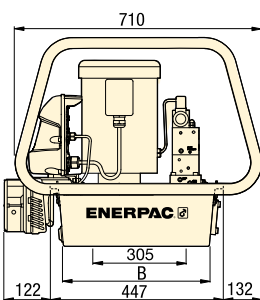

8 litres

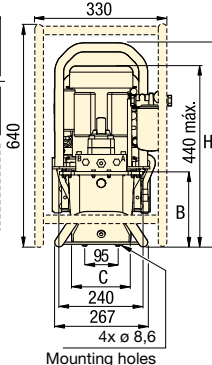
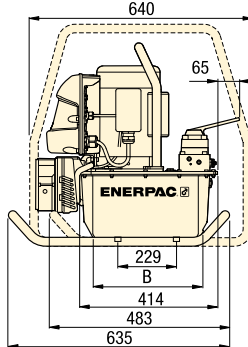

## **A** Product dimensions in mm [ ]

Usable oil capacity litres	Model number	A	B	C	D	D1	E	H	kg		
									ZW3	ZW4	ZW5
8	ZWxx08xx	206	279	206	—	—	—	574	42	42	47
10	ZWxx10xx	155	412	305	384	371	279	599	49	49	52
20	ZWxx20xx	180	412	422	500	488	396	625	61	61	65
40	ZWxx40xx	269	399	506	577	572	429	714	84	84	87

## **!** Important

Enerpac recommends a pressure differential of no less than 14 bar for most applications. If you believe your application requires a tighter differential, please contact us directly.

For complete ordering matrix of all factory-installed options see page 117.

## **g** Options

Heat exchanger

119 ▶



Level switch

120 ▶



Pressure transducer

120 ▶



Return line filter

118 ▶



# Continuous connection pumps *Application & selection*

Shown: ZW4420FE-FT



▶ The new Enerpac Continuous Connection Pump provides two modes of operation:

### Manual mode

Pump runs continuously, building pressure as long as operator holds down pendant button.

### AUTO mode

Pump runs continuously, maintaining user-set pressure window on clamp circuit as long as necessary.

■ ZW5410FE-FT used to control clamping cycle on a horizontal machining center.



## Automatic pressure control for continuous connection fixtures

- Programmable pressure setting allows pump to maintain system pressure continuously
- Includes pilot operated check valve ensuring pressure is maintained in circuit
- Z-Class high-efficiency pump design; featuring higher oil flow and by-pass pressure than comparable pumps
- High-strength, molded electrical enclosure protects electronics, power supplies and LCD readout from harsh industrial environments.

## Example Circuits

- Double-acting circuit

### ZW4410FI-FT

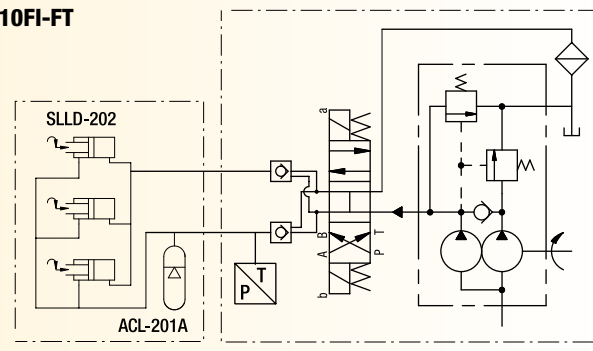

- Single-acting circuit

### ZW4410FI-FT

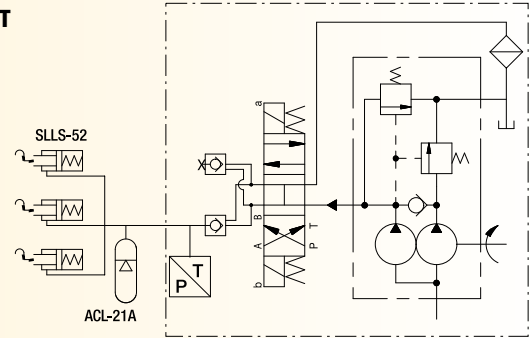

## Product selection

Flow rate @ max. pressure	Motor size	Motor voltage	Model number	Pressure range	Sound level	Usable oil capacity	
l/min	kW	V-ph-Hz		bar	dB(A)	litres	kg
0,54	0,75	115-1-50	<b>ZW3408FB-FT</b>	70-350	75	8	52
		115-1-50	<b>ZW3410FB-FT</b>				
		230-1-50	<b>ZW3408FI-FT</b>				
		230-1-50	<b>ZW3410FI-FT</b>				
0,82	0,75	115-1-50	<b>ZW4410FB-FT</b>	70-350	75	10	54
		230-3-50	<b>ZW4410FG-FT</b>				
		460-3-50	<b>ZW4410FJ-FT</b>				
1,64	1,12	115-1-50	<b>ZW5410FB-FT</b>	70-350	75	10	58
		230-3-50	<b>ZW5410FG-FT</b>				
		460-3-50	<b>ZW5410FJ-FT</b>				

### **i** Operation – continuous connection pump

**Manual mode:** The operator turns the pump motor on, and then presses and holds the up arrow on the pendant. When the button is released, the valve shifts to neutral, but pressure is maintained in the clamp circuit by the pilot-operated check valve. When the operator presses and holds the down arrow on the pendant, pressure in the clamp circuit will release, and the fixture will unclamp.

**AUTO mode:** The operator turns the pump motor on, and then presses and holds the up arrow on the pendant. When the customer-programmed HI PRESS setting is reached, the valve shifts to neutral, but pressure is maintained in the clamp circuit by the pilot-operated check valve. If pressure drops below the LO PRESS setting, the valve will re-activate and build pressure in the clamp circuit again. The pump will maintain this cycle until the operator presses and holds the down arrow on the pendant. When the down arrow is pressed, pressure in the clamp circuit will release, and the fixture will unclamp.

Flow: 0,54 - 1,64 l/min

Pressure: 350 bar

Motor: 0,75 - 1,12 kW

Reservoir: 8 - 40 litres

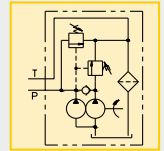
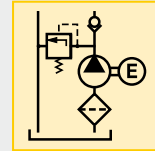

### **globe** Output oil flow versus hydraulic pressure

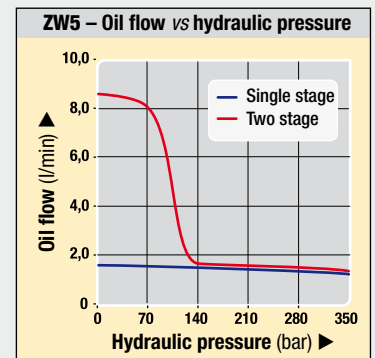
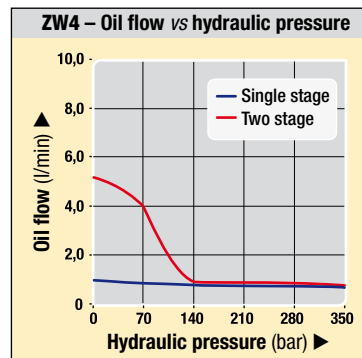
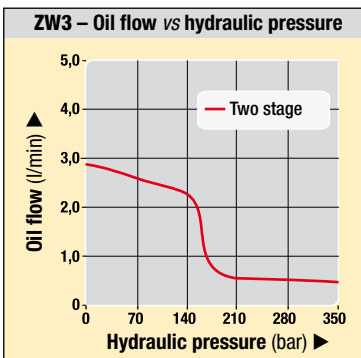

10, 20, 40 litres

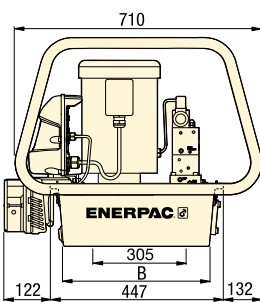

8 litres

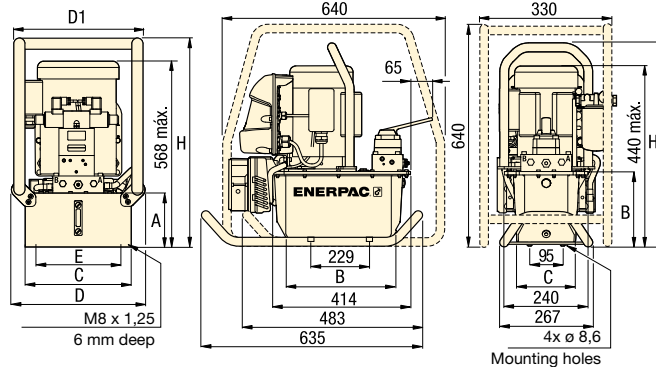

### **A** Product dimensions in mm [ ]

Usable oil capacity litres	Model number	A	B	C	D	D1	E	H	kg		
									ZW3	ZW4	ZW5
8	ZWxx08xx	206	279	206	—	—	—	574	42	42	47
10	ZWxx10xx	155	412	305	384	371	279	599	49	49	52
20	ZWxx20xx	180	412	422	500	488	396	625	61	61	65
40	ZWxx40xx	269	399	506	577	572	429	714	84	84	87

### **!** Important

Enerpac recommends a pressure differential of no less than 14 bar for most applications. If you believe your application requires a tighter differential, please contact us directly.

For complete ordering matrix of all factory-installed options see page 117.

### **globe** Options

Heat exchanger  
☐119 ▶



Level switch  
☐120 ▶



Pressure transducer  
☐120 ▶



Return line filter  
☐118 ▶





# Single station D03 pumps *Application & selection*

Shown: ZW4010GE-11



## ▶ D03 valve mounting style

Pump accepts any industry standard D03 style directional valve. Also available with 2 station and 4 station manifolds.

## ⚠ Important

**Be aware of leakage rates of any valve installed on an Enerpac pump. Many standard spool valves have excessive leakage rates at higher pressures that can limit the performance of the electric pump. Be sure to consult Enerpac if you are unsure of your choice of valve.**

■ ZW5020HW-F11 with customer installed valve used to provide pressure to a clamping fixture.

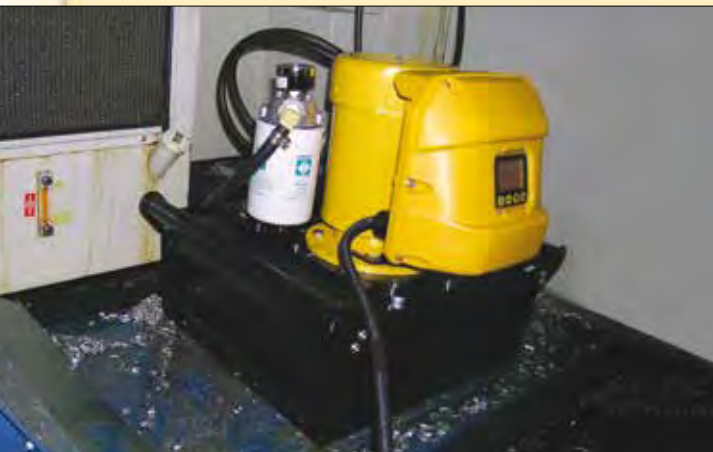

## Industry standard mounting for electric or manual valves

- Highly efficient design provides increased flow rates, reduced heat generation and a decrease in power consumption
- Extensive list of accessories including
  - Heat exchanger
  - Roll-bars
  - Pressure transducer
  - Level and temperature switches
- Replaceable piston check-valves increase service life of major pump components
- Optional backlit LCD provides pump usage information, hour and cycle counts
- Also available with 2 station and 4 station manifolds.

## 🌐 Product selection

Flow rate @ max. pressure	Motor size	Motor voltage	Model number	Pressure range	Sound level	Usable oil capacity	🏋️
l/min	kW	V-ph-Hz		bar	dBA	litres	kg
0,54	0,75	115-1-50	<b>ZW3008GB-11</b>	70-350	75	8	52
		115-1-50	<b>ZW3010GB-11</b>		75	10	61
		230-1-50	<b>ZW3008GI-11</b>		75	8	52
		230-1-50	<b>ZW3010GI-11</b>		75	10	61
0,82	0,75	115-1-50	<b>ZW4010GB-11</b>	70-350	75	10	54
		230-3-50	<b>ZW4010GG-11</b>				
		460-3-50	<b>ZW4010GJ-11</b>				
1,64	1,12	115-1-50	<b>ZW5010GB-11</b>	70-350	75	10	58
		230-3-50	<b>ZW5010GG-11</b>				
		460-3-50	<b>ZW5010GJ-11</b>				

### **i** Operation – single station D03 pumps

The Single Station D03 pumps are supplied without the standard LCD electrical control. This configuration is intended to be used with user supplied controls. Control requirements include: Motor Starter or Contactor, and remote control of the pump mounted valve. Typical applications include: Special Machines and CNC Machines where the control of the pump and valve will be done by PLC or machine control.

The use of the ZPF Return Line Filter is recommended. If the pump is to be run at pressure at a relief valve setting, the ZHE-E10 Heat Exchanger is also recommended. For monitoring of the oil level and temperature, use the ZLS-U4 Level/Temp Switch. For pump shutdown at pressure, the ZPS-W4 Pressure Switch Kit can provide an input to the customer supplied controls. As these accessories are designed to be used with the standard Enerpac LCD control, the customer assumes responsibility to adapt the standard leads to their controls.

**Flow: 0,54 - 1,64 l/min**

**Pressure: 350 bar**

**Motor: 0,75 - 1,1 kW**

**Reservoir: 8 - 40 litres**

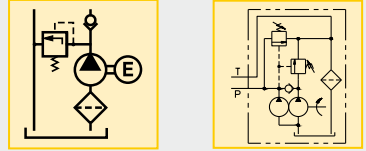

### **!** Important

Enerpac recommends a pressure differential of no less than 14 bar for most applications. If you believe your application requires a tighter differential, please contact us directly.

### **globe** Output oil flow versus hydraulic pressure

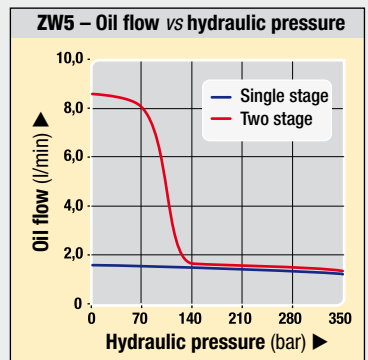
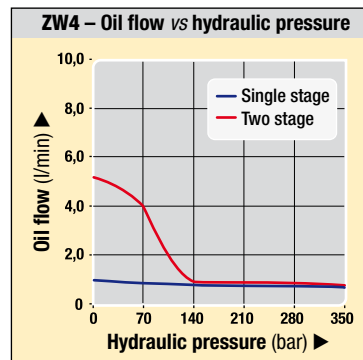
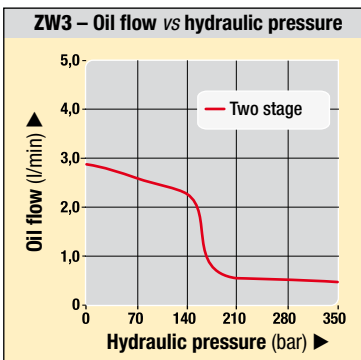

10, 20, 40 litres

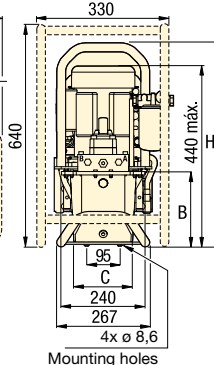
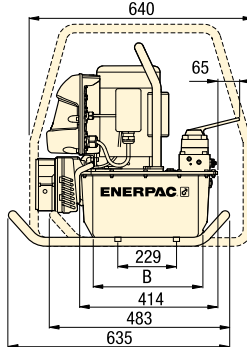
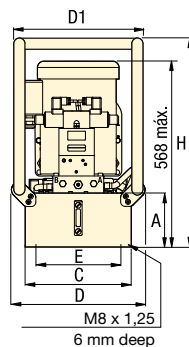
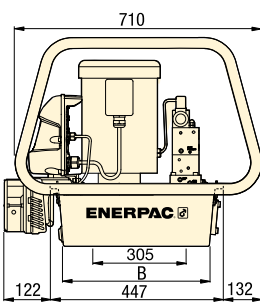

8 litres

### **A** Product dimensions in mm [ ]

Usable oil capacity	Model number	A	B	C	D	D1	E	H	kg		
									ZW3	ZW4	ZW5
litres											
8	ZWxx08xx	206	279	206	—	—	—	574	42	42	47
10	ZWxx10xx	155	412	305	384	371	279	599	49	49	52
20	ZWxx20xx	180	412	422	500	488	396	625	61	61	65
40	ZWxx40xx	269	399	506	577	572	429	714	84	84	87

### **!** Options

**Heat exchanger** [119](#)

**Level switch** [120](#)

**Pressure transducer** [120](#)

**Return-line filter** [118](#)

**VP03 solenoid valves** [141](#)

**VMM series manual valves** [143](#)

Shown: ZW5111SWE100



► Enerpac's workholding pump unit features an innovative range of zero leakage, poppet design, directional valves. With the modular valve design, various independent single-acting or double-acting circuits can be realized.

## Application

These advanced workholding pumps, operating at maximum 350 bar hydraulic pressure, are highly suitable for production tooling applications – offering the optimum in terms of compact size for required oil flow and pressure rating and customization to your specific needs.

Enerpac electric pump used in conjunction with swing cylinders, work supports, directional valves, control valves and sequence valves can provide a complete clamping solution. The pressure switch allows the unit to be fully automated.

## Customize to your needs

- Various models including electric controls and pressure switch
- Stackable to 8 VP-series valve stations high
- Customer adjustable relief valve
- Glycerine dampened pressure gauge G-2517L on pumps with VP-series valves
- 230/460/3/50/60 Hz 1,1 kW motor.

## Output oil flow

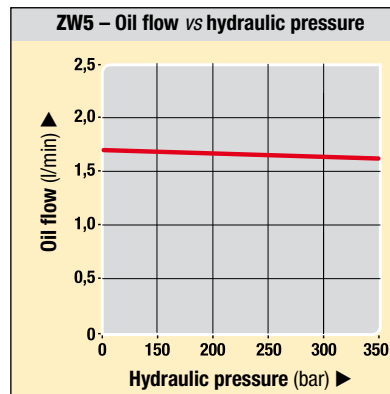

## Product selection

Oil flow rate	Pressure range	Voltage and current	Usable oil capacity <sup>2)</sup>	Valve models included	Model number	kg
l/min	bar	V @ A	litres			
<b>▼ With manifold for VP-series modular valves, no electric controls</b>						
1,64	100-350	230 @ 4,8	10,0	–	<b>ZW5VPSEE100</b>	65
1,64	100-350	400 @ 2,4	10,0	–	<b>ZW5VPSWE100</b>	65
<b>▼ With manifold for CETOP 03 valves, no electric controls</b>						
1,64	100-350	230 @ 4,8	10,0	–	<b>ZW5C03SEE100</b>	65
1,64	100-350	400 @ 2,4	10,0	–	<b>ZW5C03SWE100</b>	65
<b>▼ For 2x single-acting circuits</b>						
1,64	100-350	230 @ 4,8	10,0	1x VP-41	<b>ZW5141SEE100</b>	77
1,64	100-350	400 @ 2,4	10,0	1x VP-41	<b>ZW5141SWE100</b>	77
<b>▼ For 1x double-acting circuits + isolating valve <sup>1)</sup> for A-port</b>						
1,64	100-350	230 @ 4,8	10,0	1x VP-11	<b>ZW5111SEE100</b>	77
1,64	100-350	400 @ 2,4	10,0	1x VP-11	<b>ZW5111SWE100</b>	77
<b>▼ For 2x double-acting circuits + isolating valves <sup>1)</sup> for all A-ports</b>						
1,64	100-350	230 @ 4,8	10,0	2x VP-11	<b>ZW5211SEE100</b>	80
1,64	100-350	400 @ 2,4	10,0	2x VP-11	<b>ZW5211SWE100</b>	80

<sup>1)</sup> Isolating valve is pressure switch PSCK-8.

<sup>2)</sup> ZW5-series pumps comes standard with 8 litres reservoir. (4, 8, 20 or 40 reservoir is optional).

**ZW5-series** Shown: ZW5211SEE100 with standard 10 litres reservoir

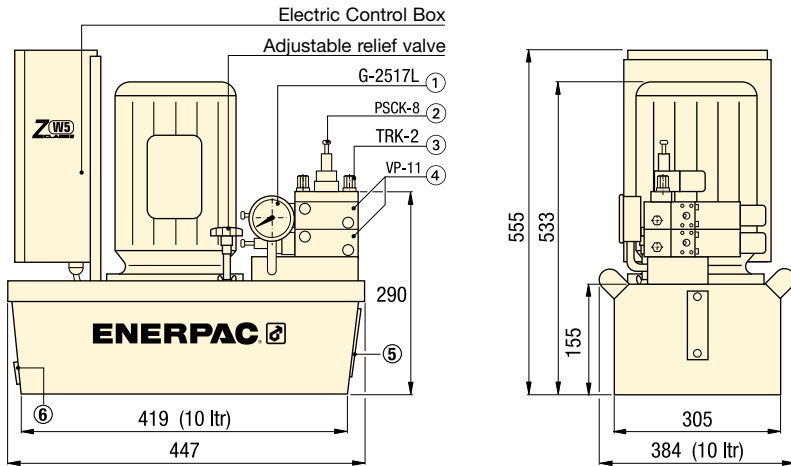

- ① Pressure gauge
- ② Pressure switch
- ③ Tie Rod Kit
- ④ Directional valve
- ⑤ Oil level glass
- ⑥ Oil drain

### Product selection

Pump series	Voltage	Phase	Continuous operation at 350 bar	Motor capacity	Motor speed	Motor protection class	Sound Level
	Volt			kW	RPM		dB(A)
<b>ZW5....</b>	230	1	50%	1,1	1390	IP54	75
<b>ZW5.....</b>	400	3	50%	1,1	1390	IP54	75

### Valve options

See page 136 for VP-series valves and available options.

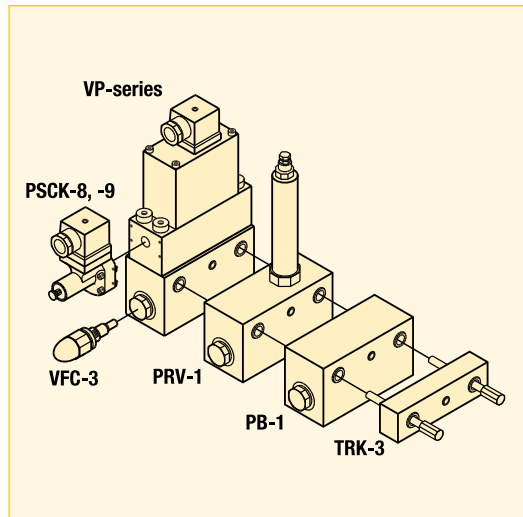

See page 141 for VP03-series valves and available options.

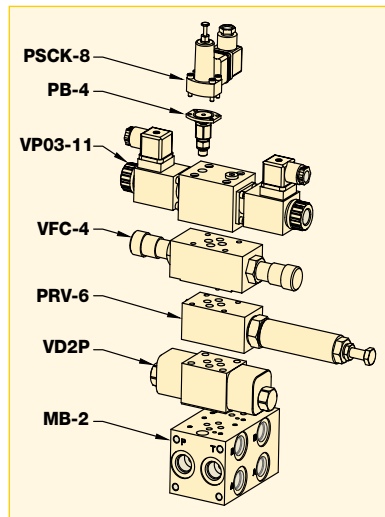

- Flow: 1,64 l/min**
- Pressure: 100 - 350 bar**
- Motor: 1,1 kW**
- Reservoir: 4 - 40 litres**

- E Bombas eléctricas**
- F Centrale hydraulique**
- D Modulare Spannumppe**

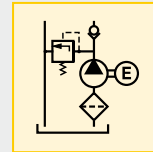

### Options

**VP-series, modular valves**  [136](#)

**VFC-3 flow control valve**  [137](#)

**Pressure switches**  [188](#)

**Hoses and couplers**  [192](#)

**High-pressure filters**  [193](#)

**Fittings**  [194](#)

# Electric Driven Workholding Pumps *Application & selection*

Shown: ZW5111SWE100



## ZW5 series

These advanced workholding pumps, operating at maximum 350 bar hydraulic pressure, are highly suitable for production tooling applications – offering the optimum in terms of compact size for required oil flow and pressure rating and customization to your specific needs.

### Application

Enerpac electric pump used in conjunction with swing cylinders, work supports, directional valves, control valves and sequence valves can provide a complete clamping solution. The pressure switch allows the unit to be fully automated.

■ Enerpac VP-series valves stackbuilt on ZW5211SWE100. The pressure switch PSCK-8 is mounted directly onto the endplate of Tie Rod Kit TRK-2.

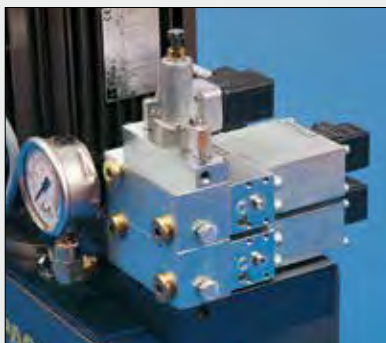

## ZW5VPSEE100 with manifold for VP-series or CETOP 03 valves, without electric controls and gauge

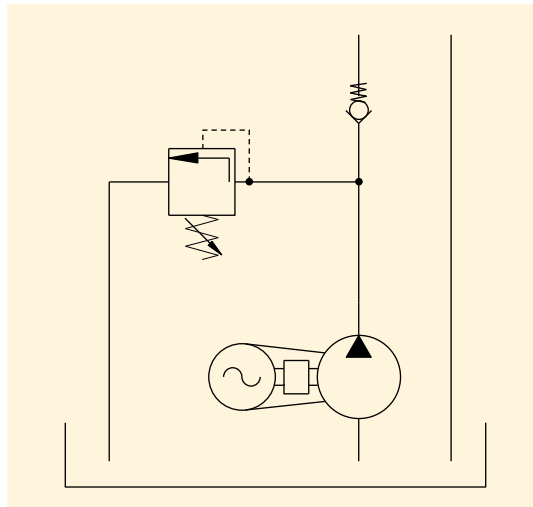

## ZW5111SEE100 For 1x Double-Acting circuit and Isolating Valve for A-port

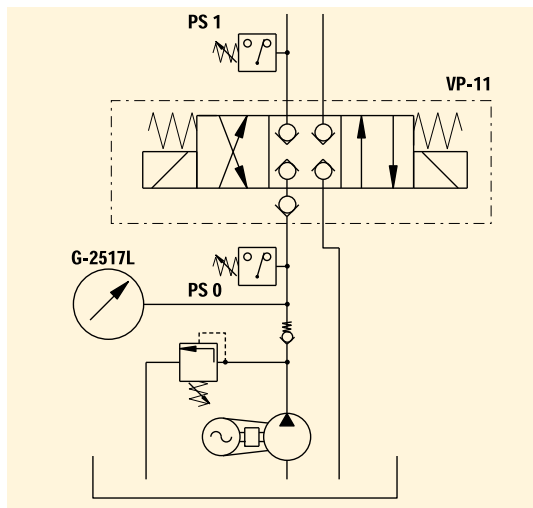

## ZW5141SEE100 For 2x Single-Acting circuits

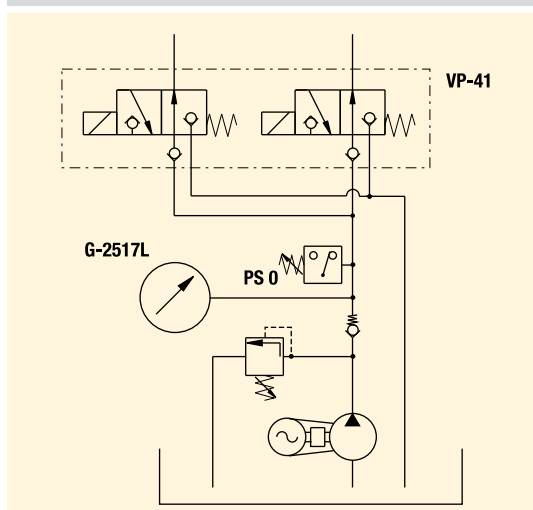

### Basic pumps

Customize to your needs with the Enerpac VP-series valves and options or choose your own D03 valve.

### Isolating valves

For applications where clamping pressure has to be maintained, isolating valves are an economic and safe solution.

The pressure switch (PS 1) switches in the hydraulic line to the cylinder actuates the valve with a closed center position and isolates the circuit when the preset pressure has been reached. In case of pressure drop the switch opens the valve to compensate.

For some particular applications, i.e., when a workpiece has to be positioned and clamped with different forces, you can set different isolating valve pressures for the independent circuits.

Pressure switch (PS 0) switches the motor off at maximum pressure; in case of pressure drop due to activating circuits, the motor restarts.

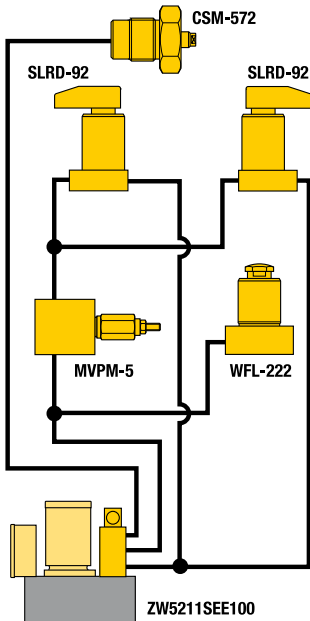

**ZW5211SEE100 for 2x Double-Acting circuit and Isolating Valve for all A-ports**

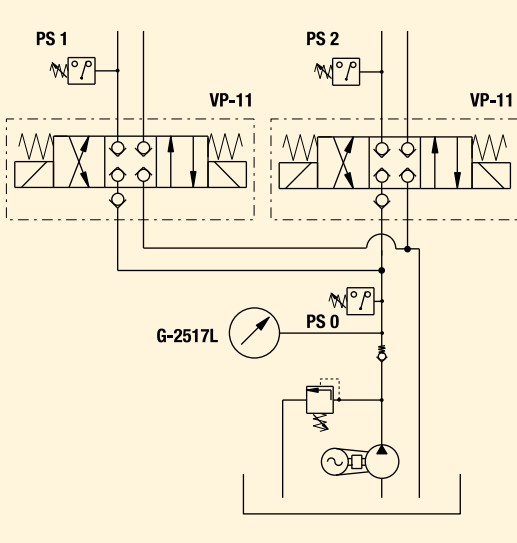

**Application example**

Building the right workholding system for a specific production tooling requirement is best achieved by observing the Basic System Set-up in our “Yellow Pages” (☐202 ▶).

**Electric Scheme**

Shown the electric scheme of the ZW5211SWE100 (400 volt) for two double-acting circuits and isolating valves (pressure switches) in both A-lines.

**ZW5211SWE100**

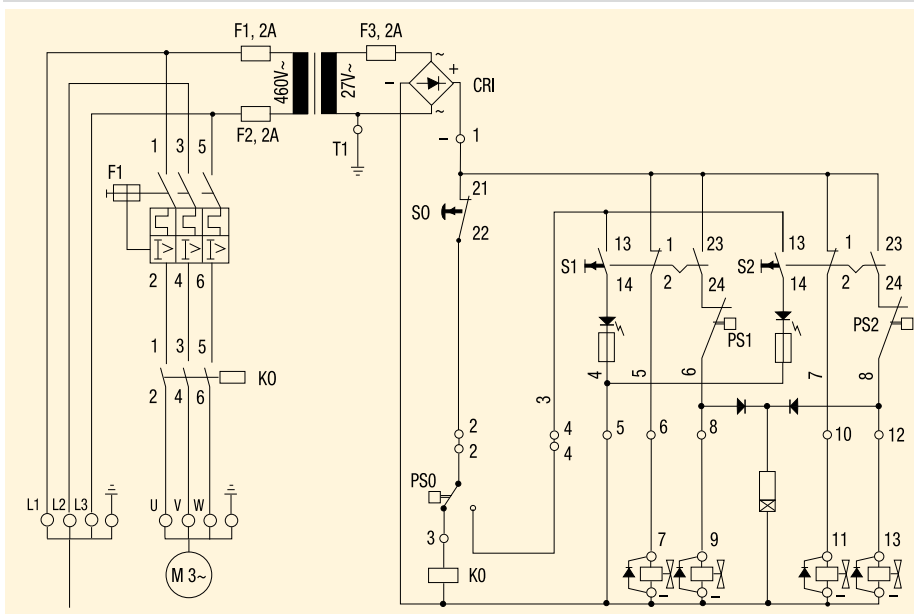

**Flow: 1,64 l/min**

**Pressure: 100 - 350 bar**

**Motor: 1,1 kW**

**Reservoir: 4 - 40 litres**

- E** Bombas eléctricas
- F** Centrale hydraulique
- D** Modulare Spannumppe

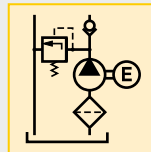

**Options**

**Sequence valves** 

☐152 ▶

**Flow control valves** 

☐155 ▶

**Hoses and couplers** 

☐192 ▶

**High pressure filters** 

☐193 ▶

**Hydraulic oil** 

☐193 ▶

**Fittings** 

☐194 ▶

**VP-series valve options** 

☐136 ▶

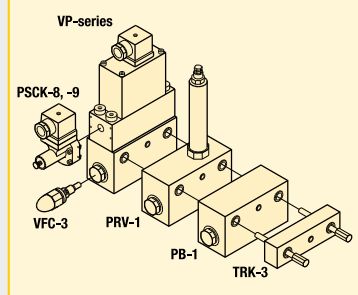

Shown: SP-621, P-51, P-142



## P series

Single and two-speed hand operated pumps for operation of single-acting cylinders.

### SP-621 Screw pump

Single speed non-vented, internally sealed screw pump to operate single-acting cylinders. Can be mounted in any position and used to operate a single fixture. The piston is screwed into the pump, forcing the oil in the hydraulic system.

## Exclusively from Enerpac

...to power single-acting cylinders

- Internal pressure relief valve (except SP-621) prevents over-pressurization
- Two speed operation reduces handle strokes by as much as 78% over single speed pumps
- Low handle effort minimizes operator fatigue
- Compact size – enables easy conversion of manual fixtures to hydraulic power

Flow: 0,9 - 4,1 cm<sup>3</sup>/stroke

Pressure: 210 - 700 bar

Reservoir: 0,1 - 0,9 litres

**E** Bombas manuales

**F** Pompes à main

**D** Handpumpen



## Options

### Fittings

194 ▶



### Hoses

192 ▶



### Hydraulic oil

193 ▶



## Important

**P-141, P-142 and P-202** are designed for a maximum operat 700 bar.

### SP-621

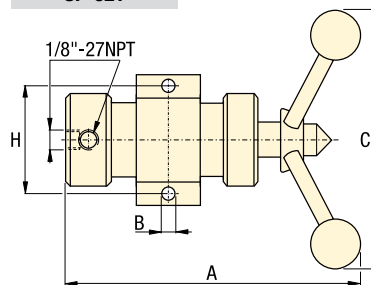

### P-51

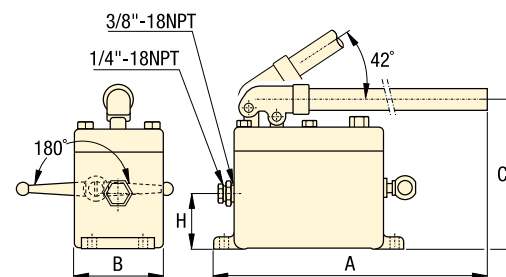

### P-141, -142, -202

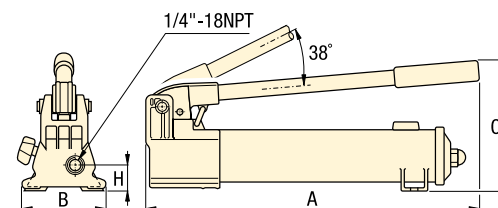

## Product selection

Maximum hydraulic pressure	Usable oil capacity	Model number	Pressure rating		Oil volume per stroke		Piston stroke	Maximum handle effort	Dimensions (mm)				kg
			bar	bar	cm <sup>3</sup>	cm <sup>3</sup>			A	B	C	H	
bar	cm <sup>3</sup>		1st stage	2nd stage	1st stage	2nd stage	mm	kg	A	B	C	H	kg
<b>▼ Single speed</b>													
210	100	<b>SP-621</b>	–	210	–	1)	1)	27 <sup>2)</sup>	256	10	315	72	3,2
210	820	<b>P-51</b>	–	210	–	4,10	25,4	28	660	92	160	57	5,5
700	325	<b>P-141</b>	–	700	–	0,90	12,7	33	336	95	143	29	2,0
<b>▼ Two speed</b>													
350	325	<b>P-142</b>	13,8	700	3,62	0,90	12,7	35	336	95	143	29	2,0
350	325	<b>P-142-5000</b>	13,8	350	3,62	0,90	12,7	35	336	95	143	29	2,0
700	900	<b>P-202</b>	13,8	700	3,62	0,90	12,7	29	509	95	143	29	3,4

1) Handle travel of SP-621 is 63,5 mm; 25 handle rotations displace 102 cm<sup>3</sup> of oil.  
2) Handle effort on SP-621 is 81 Nm at 210 bar

## Air Powered Pump with Manual Valve

This system uses a PASG5002SB Turbo II air powered pump with a VMMD-001 manual valve to control a fixture circuit with single acting swing clamps and work supports. A VDP-1 check module in the valve stack locks the pressure in the system. A WVP-5 sequence valve delays the actuation of the works support until the swing clamp is clamped.

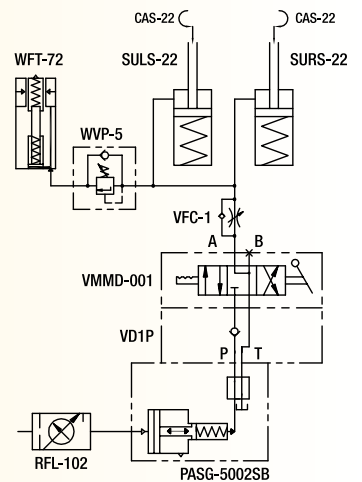

## Air Powered Pump with Dual Solenoid Valves

This system uses a PACG30S8S-MB2 Turbo II air powered pump with two VP03-11 solenoid valves to control two independent fixture circuits with double acting swing clamps and work supports. Flow controls in the valve stack provide control of the cylinder actuation speed. Sequence valves delay the actuation of the work supports until the swing clamps are clamped.

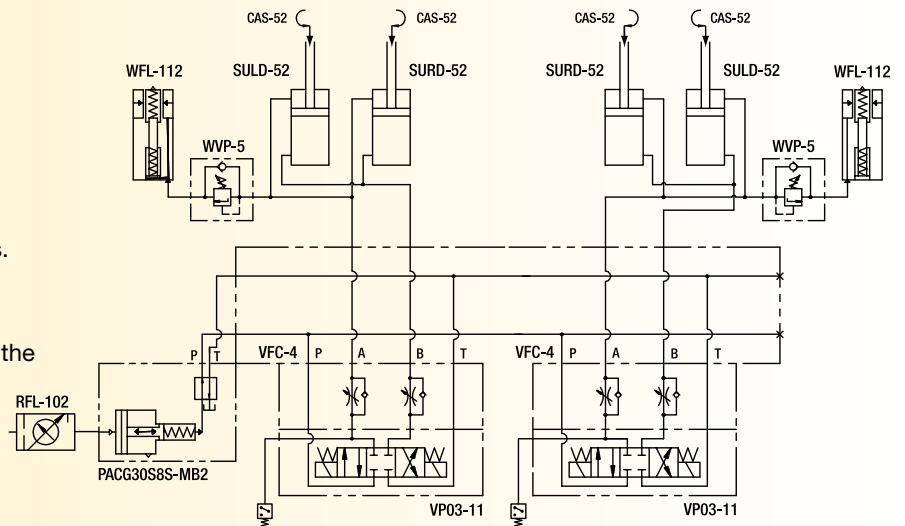

## Electric Pump with Dual Solenoid Valves

This system uses a ZW3020HE-FT12 electric pump and two VP-11 solenoid valves to control two independent fixture circuits with double acting swing clamps and work supports. Flow controls mounted in the valves provide control of the cylinder actuation speed. Pressure switches on the "clamp" circuit can provide confirmation of clamping pressure. Sequence valves delay the actuation of the work supports until the swing clamps are clamped.

