

NUFLO™

Scanner® 2000 Expansion Board

QuickStart

The Scanner 2000 Expansion Board expands the Scanner 2000's input/output to include:

- an additional turbine input
- a pulse input (3-30 VDC or contact closure)
- two analog inputs (1-5 V, 0-5 V, or 4-20 mA)
- an analog output (4-20 mA)

Installation

Before installing the expansion board, remove all power from the Scanner 2000 (battery and external power). The expansion board attaches to two headers positioned between the two large terminal blocks on the main board. Remove wiring from the main board if necessary to guide the expansion board into position.

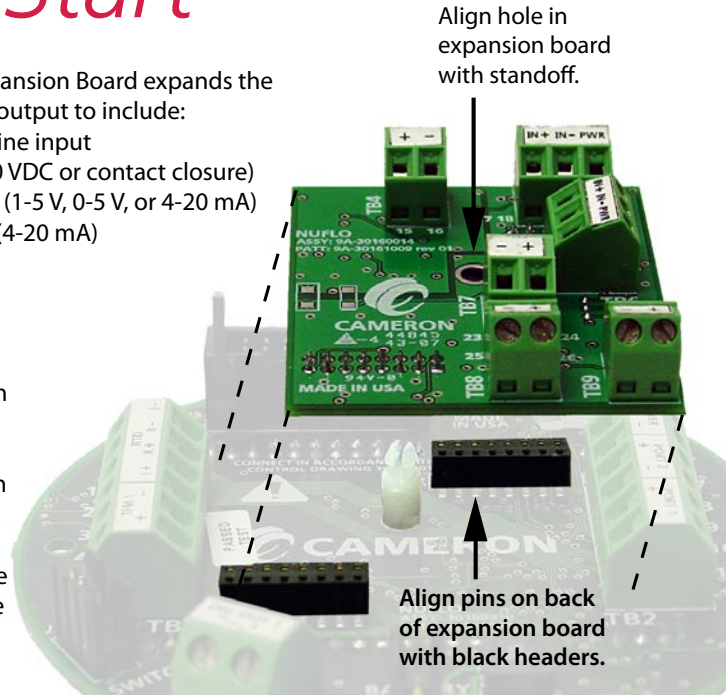

CAUTION: FAILURE TO ALIGN PINS AND HEADERS CAN DAMAGE THE BOARDS.

1. Remove the standoff from packaging and press it into the hole near the center of the main board until it snaps into place.
2. Guide the expansion board over the stand-off and align the pins on the under side with the headers on the main board.

- When the board is positioned correctly, text on both boards should face the same direction.
3. Gently press the expansion board and the main board together until the expansion board snaps into place over the standoff.

4. Restore wiring connections to the main board, reconnect the MVT if disconnected, and make field wiring connections to the expansion board.
5. Restore power to the Scanner 2000 and reboot the Scanner to allow detection of the expansion board.

Turbine Input 2

The Turbine Input 2 accepts a turbine flowmeter input signal generated by a magnetic pickup. The Scanner 2000 can be configured to use this signal to calculate and display instantaneous flow rates and accumulated totals.

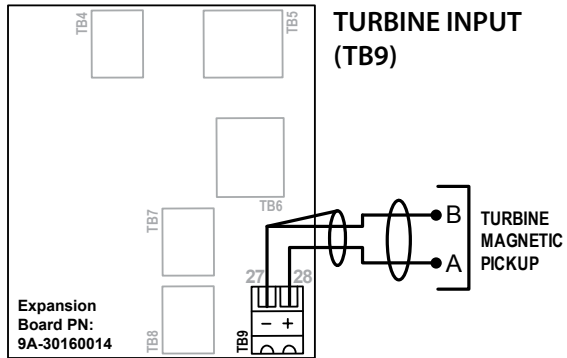

Another turbine input (Turbine Input 1) is provided on the main circuit board. When the expansion board is installed, a differential pressure flow run and two turbine runs can be monitored and logged simultaneously.

Pulse Input

The pulse input provides an optically isolated input for high-amplitude pulse (frequency) signals, which includes signals from a turbine meter equipped with a preamplifier or signals from a PD meter (via contact closure).

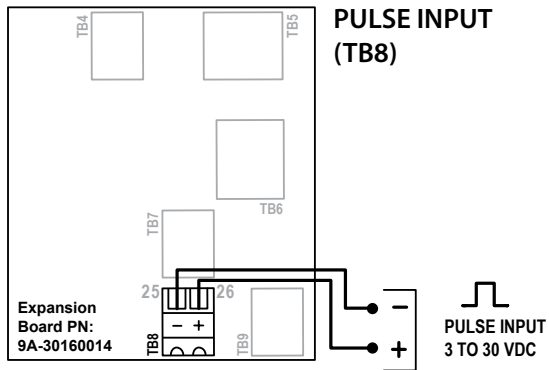

The Scanner 2000 can calculate flow from no more than two pulse (frequency) inputs at a time. Therefore, a pulse input can be used simultaneously with only one turbine input (main board or expansion board).

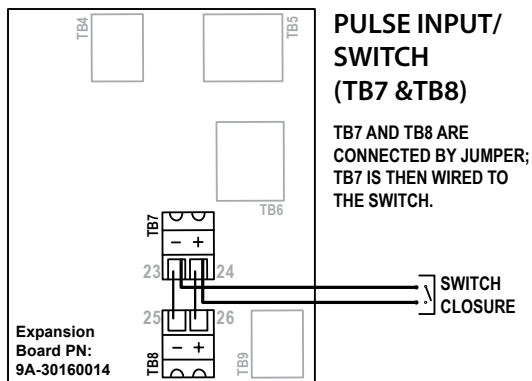

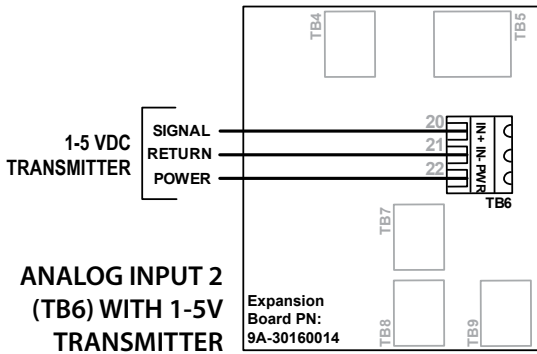
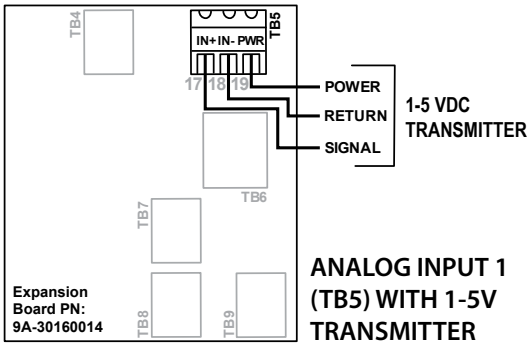

4-20 mA TRANSMITTER WIRING (CAN BE USED WITH ANALOG INPUT 1 OR 2)

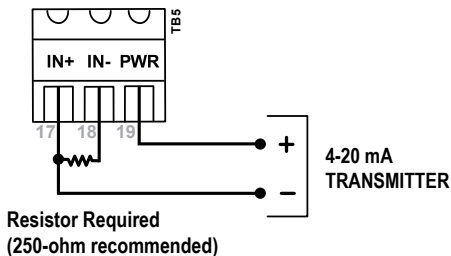

Analog Inputs

The analog inputs, which can be configured for a 1-5 V, 0-5 V or 4-20 mA signal, can receive readings from a pressure or temperature sensor for use in AGA-7 gas calculations. Alternatively, they can be used to log measurements from any device with a 1-5 V, 0-5 V or 4-20 mA output.

Transmitter power is provided by the Scanner only when the Scanner is externally powered. The output voltage equals the input voltage less 0.25 VDC, and is limited to 20 mA.

If a 4-20 mA transmitter is used, a resistor must be added to the circuit. The expansion board circuit will support a resistor range of 200 to 300 ohms; 250 ohms is recommended.

Configuring Inputs/Outputs

All inputs and outputs are configured with ModWorX™ Pro software provided with each Scanner 2000 microEFM.

ANALOG OUTPUT (TB4) WITH POWER SUPPLIED VIA MAIN BOARD (TB2)

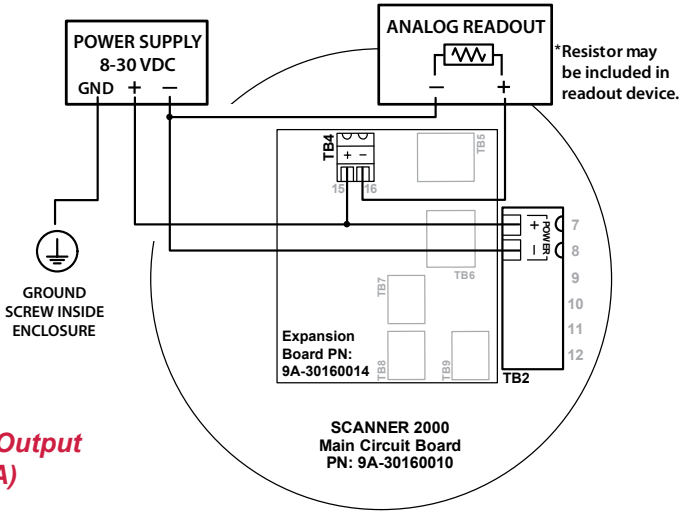

Analog Output (4-20 mA)

The 4-20 mA linear current output can be configured with ModWorX™ Pro software to represent any parameter in the holding registers. This output requires a two-conductor cable to be connected to an 8 to 30 VDC power supply (voltage required is dependent on loop resistance) and an analog readout device to be located in the remote location.

The graph above shows the minimum voltage

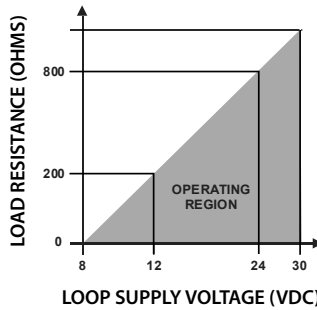

required to power the instrument for a given loop resistance. In addition, the mathematical relationship between loop voltage and load resistance is given.

$$R_L \text{ MAX} = \frac{(V_{loop} - 8V)}{20 \text{ mA}}$$

$$R_L \text{ MAX} = \frac{(24V_{loop} - 8V)}{20 \text{ mA}}$$

$$R_L \text{ MAX} = 800 \text{ ohms}$$

For example, if a power supply voltage of 24 volts is available to power the current loop, the maximum load resistance would be 800 ohms.

MEASUREMENT SYSTEMS

HOUSTON HEAD OFFICE | 281.582.9500

NORTH AMERICA

 1.800.654.3760
ms-us@c-a-m.com

ASIA PACIFIC

 +603.2287.1039
ms-asiapacific@c-a-m.com

EUROPE, MIDDLE EAST & AFRICA

 +44.1243.826741
ms-uk@c-a-m.com

 USA • CANADA • UK • SCOTLAND • CHINA • UAE • ALGERIA • MALAYSIA • INDIA • KENYA • www.c-a-m.com/flo