



Display Pressure Switch



measuring
•
monitoring
•
analysing

PSD



- Measuring range: -1 ... +1.5 to 0 ... 600 bar
- Temperature: -25 °C ... +85 °C
- Accuracy (at 25 °C): ±0.5 % FS
- Connection: G 1/4 male (other via adapter)
- Analogue output switchable mA or V
- Switching output: 2 transistors PNP
- Pressure range adjustable, 50 ... 100 % of the nominal range
- Display housing and electrical connection are independently rotatable 335°/343°
- 3-key programming



P2

KOBOLD companies worldwide:

ARGENTINA, AUSTRALIA, AUSTRIA, BELGIUM, BULGARIA, CANADA, CHILE, CHINA, COLOMBIA, CZECHIA, EGYPT, FRANCE, GERMANY, GREAT BRITAIN, HUNGARY, INDIA, INDONESIA, ITALY, MALAYSIA, MEXICO, NETHERLANDS, PERU, POLAND, REPUBLIC OF KOREA, ROMANIA, SINGAPORE, SPAIN, SWITZERLAND, TAIWAN, THAILAND, TUNISIA, TURKEY, USA, VIETNAM

KOBOLD Messring GmbH
Nordring 22-24
D-65719 Hofheim/Ts.
Head Office:
+49(0)6192 299-0
+49(0)6192 23398
info.de@kobold.com
www.kobold.com



Description

The PSD is the ideal combination of pressure switch and transmitter with display. The parameters can be set directly on the device. The settings in combination with a comprehensive set of options make the PSD suitable for a wide range of demanding applications.

Applications

- Machine tools
- Hydraulics
- Process technology
- Industrial applications

Technical Details

Measuring principle:	thin film on steel
Measuring range:	-1 ... +1.5 to 0 ... 600 bar -14.5 ... +22 to 0 ... 7500 psi adjustable 50 ... 100 % FS
Output signal:	4 ... 20 mA 0 ... 10 V _{DC} , switchable mA or V
Switching output:	2 transistors PNP
Accuracy @ 25 °C typ.:	± 0.5 % FS typ.
Media temperature:	-25 °C ... +85 °C
Ambient temperature:	-25 °C ... +85 °C
Pressure unit for display:	bar, psi, MPa, kPa, m WC, mm WC

Electrical data

Output/supply voltage:	4 ... 20 mA or 0-10 V _{DC} / 24 (15 ... 30) V _{DC}
Switch-on-delay:	typ. 200 ms
Inverse-polarity protection, short-circuit strength @ 25 °C during 5 min.:	integrated
Current consumption:	≤ 30 mA

Environmental conditions

Media temperature:	-25 °C ... +85 °C
Ambient temperature:	-25 °C ... +85 °C
Protection ¹⁾ :	IP65
Humidity:	max. 95 % relative
Vibration:	10 g (10 ... 2000 Hz)
Shock:	50 g/3 ms

¹⁾ See »Electrical Connection«

Analogue Output

Output signal:	switchable 4-20 mA or 0-10 V _{DC}
Accuracy:	TEB ²⁾ @ -25 ... +85 °C [% FS typ.] ± 1.75 accuracy @ +25 °C [% FS typ.] ± 0.5 NLH ²⁾ @ +25 °C (BSL) ²⁾ [% FS typ.] ± 0.2 TC ²⁾ zero point and span [% FS/K typ.] ± 0.03 long term stability 1 year [% FS typ.] ± 0.1

Current limiting output signal:	4-20 mA: 25 mA (overload) 0 ... 10 V _{DC} : < 40 mA (short-circuit)
Damping (rise time):	0.01 ... 3.00 s / 10 ... 90 % nominal pressure

Switching Output

Accuracy:	accuracy @ +25 °C [% FS typ.] ± 0.5 TEB ²⁾ @ -25 ... +85 °C [% FS typ.] ± 1.0 long term stability 1 year [% FS typ.] ≤ ± 0.3
Adjustment range of switchpoints:	0 ... 100 % FS
Switching hysteresis:	≥ 1 % FS switchpoint > reset point
Switching resistance:	≤ 3 Ω
Output function:	hysteresis, window; normally open (NO), normally closed (NC)
Switching current:	≤ 0.5 A each switching output
Current limiting:	≤ 2 A each switching output
Switching frequency:	max. 200 Hz
Delay time:	0 ... 99.99 s

Display

Display:	4-digit 7-segment display 180° flippable with disable function standard decimal places: ≤ 9: 3 decimal places 10 ... 99: 2 decimal places 100 ... 999: 1 decimal place
----------	---

Switching status indication:	2 LED, red
Operation:	with 3 buttons and menu navigation according to VDMA 24574-1

Display resolution:	0.1 % FS
Display range:	-3 ... 103 % FS
Setting parameters:	see table »Parameter«

²⁾ See »Terminology«



Mechanical Data

Sensor (wetted parts): 1.4542 (AISI630)
 Pressure connection (wetted parts): 1.4542 (AISI630)
 Housing: steel, die cast metal galvanised
 display housing plastic
 Connection: G ¼ male, adapter can be ordered as separate item
 Sealing: FPM
 Male electrical plug: PA-plug M12x1.5-pin
 Mounting torque: 15...20 Nm
 Housing alignment: display 335° rotatable, max. 2.5 Nm
 electrical connection 343° rotatable, max. 5 Nm
 Pressure peak damping element: Ø 0.4 mm
 Weight: ~189 g

Measuring Accuracy 0.5 %

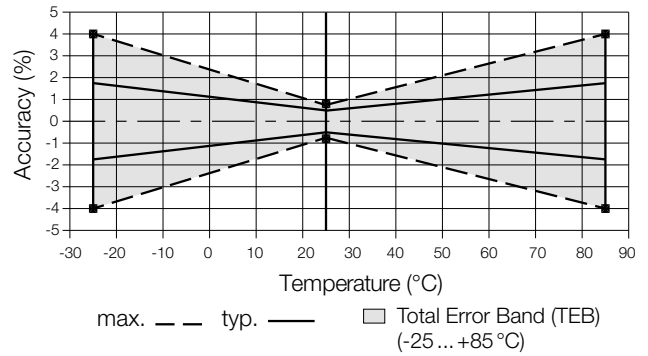

Measuring range [bar]	Overpressure [bar]	Burst pressure [bar]
0...2.5	7.5	50
0...24	12	60
0...6	18	100
0...10	30	200
0...16	48	200
0...25	75	300
0...40	120	300
0...60	180	400
0...100	300	500
0...160	480	750
0...250	750	1000
0...400	1000	2000
0...600	1500	2500



Display Pressure Switch Model PSD

Order Details Display Pressure Switch (Example: PSD-4 3 3 R2 B4 4)

Model	Version	Electrical connection	Material	Connection	Measuring range [bar]	Option	Special version
PSD-	4 = 2xPNP switching output, analogue output 4-20 mA	3 = M12 plug, 24 (15-30) V _{DC}	3 = FPM O-ring, stainless steel connection	R2 = G ¼ male	A1 = -1...1.5 A4 = -1...9 B4* = 0...2.5 B5* = 0...4 B6 = 0...6 B7 = 0...10 B8 = 0...16 B9 = 0...25 B0* = 0...40 C1* = 0...60 C2 = 0...100 C3 = 0...160 C4 = 0...250 C5 = 0...400 C6* = 0...600	4 = pressure peak damping element D = 0.4 mm	0 = none Y = special version (specify in clear text)

* Minimum order quantity: 50 pieces per measuring range

Accessories (connection adapters)

Model KOBOLD	Material	Description	Female thread	Male thread
MZB-712/7170	VA 1.4571	nipple + socket for DIN3852-E	G ¼ female x 15	G ½ B
MZB-712/7171	VA 1.4571	nipple + socket for DIN3852-E	G ¼ female x 15	G ⅝ B
MZB-712/7172	VA 1.4571	nipple + socket for DIN3852-E	G ¼ female x 15	½" NPT
MZB-712/7173	VA 1.4571	nipple + socket for DIN3852-E	G ¼ female x 15	⅜" NPT
MZB-712/7174	VA 1.4571	nipple + socket for DIN3852-E	G ¼ female x 15	¼" NPT
MZB-712/7175	VA 1.4571	nipple + socket for DIN3852-E	G ¼ female x 15	7/16"-20 UNF DIN3866
MZB-712/7176	VA 1.4571 + FPM	nipple + socket for DIN3852-E	G ¼ female x 15	G ½ DIN 3852-E
MZB-712/7177	VA 1.4571	nipple + socket for DIN3852-E	G ¼ female x 15	M20x1,5
MZB-712/7179	VA 1.4571	nipple + socket for DIN3852-E	G ¼ female x 15	G ¼ B

Accessories (connection cable/box)

Model KOBOLD	Cable length	Description	Number of contacts
ZUB-KAB-12K502	2 m	M12 connection cable	5
ZUB-KAB-12K505	5 m	M12 connection cable	5
ZUB-KAB-12K510	10 m	M12 connection cable	5
ZUB-KAB-12D500	NA	M12 box, screw connection	5



Parameter

Name	Standard setting (accessory ZS)	Value range	Short name
Switch point SP1 (hysteresis mode) Upper switch point FH1 (window mode)	75 % measuring range	SP1 > RP1 FH1 > FL1 hysteresis ≥ 1 % FS	SP1
Reset point RP1 (hysteresis mode) Lower switch point FL1 (window mode)	25 % measuring range	RP1 < SP1 FL1 < FH1 hysteresis ≥ 1 % FS	RP1
Switch point SP2 (hysteresis mode) Upper switch point FH2 (window mode)	75 % measuring range	SP2 > RP2 FH2 > FL2 hysteresis ≥ 1 % FS	SP2
Reset point RP2 (hysteresis mode) Lower switch point FL2 (window mode)	25 % measuring range	RP2 < SP2 FL2 < FH2 hysteresis ≥ 1 % FS	RP2
Switch point delay time SP1 (hysteresis mode) Switch point delay time FH1 (window mode)	0	0 ... 99.99 s	dS1
Switch point delay time RP1 (hysteresis mode) Switch point delay time FL1 (window mode)	0	0 ... 99.99 s	dR1
Switch point delay time SP2 (hysteresis mode) Switch point delay time FH2 (window mode)	0	0 ... 99.99 s	dS2
Switch point delay time RP2 (hysteresis mode) Switch point delay time FL2 (window mode)	0	0 ... 99.99 s	dR2
Functions switching output 1	Hysteresis, closer (Hno)	Hysteresis NO (Hno), hysteresis NC (Hnc), window NO (Fno), window NC (Fnc)	ou1
Functions switching output 2	Hysteresis, closer (Hno)	Hysteresis NO (Hno), hysteresis NC (Hnc) window NO (Fno), window NC (Fnc)	ou2
Pressure units	bar	bar, psi, MPa, kPa, m WC	uni
Measuring range adjustment	100 % nominal pressure	50 ... 100 % nominal	P-EP
Damping (analogue output)	0.01 s	0.01 ... 3.00 s (time constant)	dAA
Display rotation	no	no, yes (180°)	disr
Display mode	Current pressure value	Pressure value: current, highest, lowest, display off Current value: decimal places selectable (max. 3)	dis
Display update	2	1, 2, 5, 20 Hz	duPd

Dimensions [mm]

PSD

PSD-...R2...

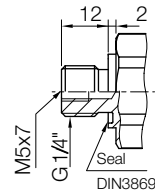
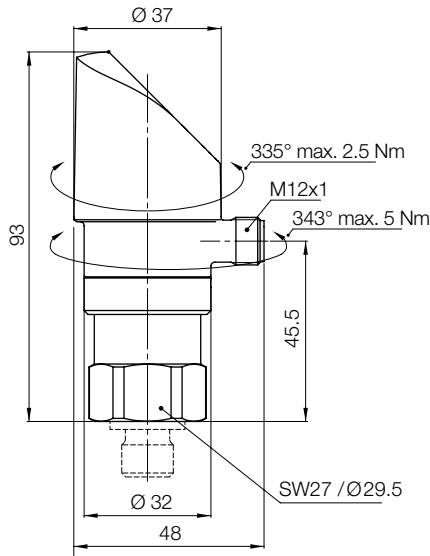

Electrical Connection

Protection/electrical connection	
IP65	
M12x1	
5-pole	
Pin assignment	
	Us+ = 1
	Us- = 3
	Output = 2
	SP1 = 4
	SP2 = 5
	Shield

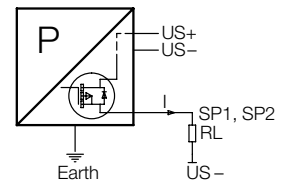
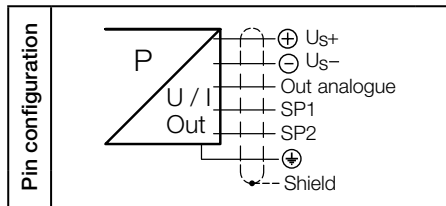

Connection of loads to switching output

Functions Switching Output

Hysteresis

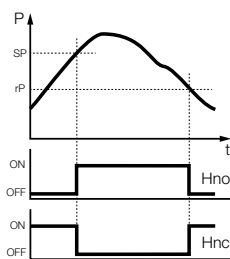

Window

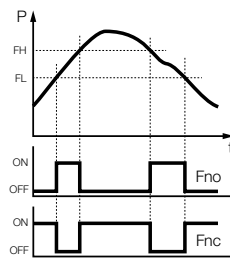

Delay

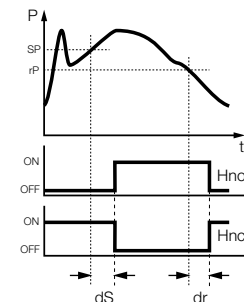



Non-linearity

The largest deviation from the effective characteristic line of an ideal reference line. The reference line can be defined as a limit point adjustment, a BSL or a BSL through 0.

Specifications: Non-linearity, Hysteresis

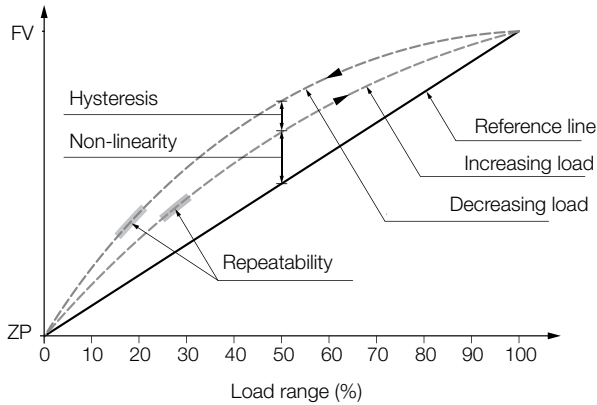

BSL Best Straight Line

The reference line according to the BSL or the minimum value adjustment is placed in such a way that the maximum positive and negative deviations are as small as possible.

Specifications: Non-linearity, Hysteresis

Specifications: Accuracy NLH (BSL)

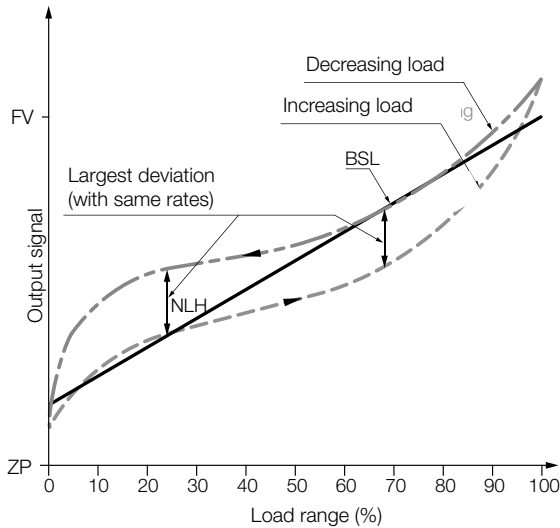

BSL through Zero

As an additional requirement for the minimum value adjustment, the BSL through zero (also BSL/0) must go straight through zero or the origin.

Specifications: Accuracy NLH (BSL through zero)

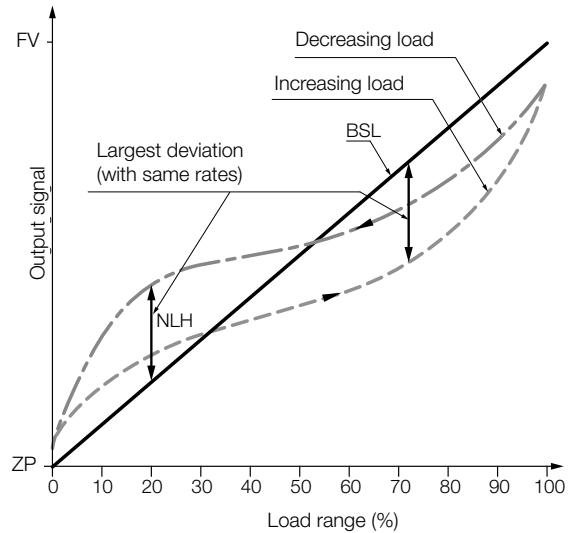

NLH Non-linearity and Hysteresis

Largest deviation from the ideal characteristic line (BSL, BSL/0 or limit point). In pressure measuring instruments, the non-linearity and pressure hysteresis are given together at a constant temperature.

Temperature Coefficient TC

Change of measured value for zero point and span as a result of changes in temperature

Long-term Stability Long-term Drift

The change of accuracy due to aging under certain reference conditions during a certain period of time, typically 1 year.

TEB Total Error Band

Total error (root from sum of the square of the deviations) due to measurement deviations (accuracy) and temperature influence (temperature coefficient TC). The temperature influence is usually given in the information across a range larger than that given in the standard (-10...+60°C). Whilst DIN 16086 also continues to add to the long-term stability over a year, the information is subject to ex-works conditions for obvious reasons.