

Temperature measurement

Temperature transmitters
Rail transmitters

SITRANS TR300 (4 to 20 mA, HART, universal)

Overview



Robust and durable HART - the universal SITRANS TR300 transmitter

- 2-wire device for 4 to 20 mA, HART
- Device for rail mounting
- Universal input for virtually any type of temperature sensor
- Configurable over HART

Benefits

- Compact design
- Galvanic isolation
- Test sockets for multimeters
- Diagnostics LED (green/red)
- Sensor monitoring open circuits and short-circuits
- Self-monitoring
- Configuration status stored in EEPROM
- Expanded diagnostic functions, such as slave pointer, operating hours counter, etc.
- Special characteristic
- Electromagnetic compatibility to EN 61326 and NE21
- SIL2 (with order note C20), SIL2/3 (with C23)

Application

SITRANS TR300 transmitters can be used in all industrial sectors. Their compact design enables simple mounting on standard DIN rails on-site in protective boxes or in control cabinets. The following sensors/signal sources can be connected over their universal input module:

- Resistance thermometer (2, 3, 4-wire connection)
- Thermocouples
- Resistance-based sensors and DC voltage sources

The output signal is a direct current from 4 to 20 mA in accordance with the sensor characteristic, superimposed by the digital HART signal.

Transmitters of the "intrinsically safe" type of protection can be installed within potentially explosive atmospheres. The devices meet the directive 2014/34/EU (ATEX).

Function

The SITRANS TR300 is configured over HART. This can be done using a handheld communicator or even more conveniently with a HART modem and the SIMATIC PDM parameterization software. The configuration data are then permanently stored in the non-volatile memory (EEPROM).

Once the sensors and power supply have been correctly connected, the transmitter outputs a temperature-linear output signal and the diagnostics LED displays a green light. In the case of a sensor break, the LED flashes red, an internal device fault is indicated by a steady red light.

The test socket can be used to connect an ammeter at any time for monitoring purposes and plausibility checks. The output current can be read without any interruption, or even without opening the current loop.

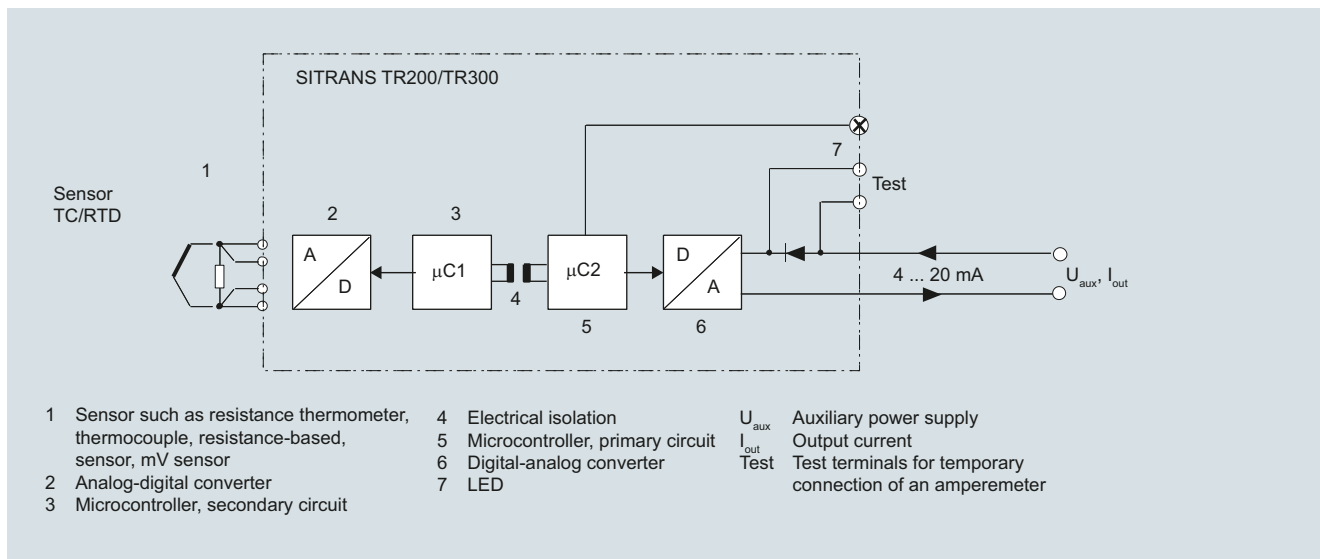

SITRANS TR300 function diagram

Technical specifications

Input

Resistance thermometer

Measured variable	Temperature
Sensor type	
• According to IEC 60751	Pt25 ... Pt1000
• Acc. to JIS C 1604; $\alpha=0.00392 \text{ K}^{-1}$	Pt25 ... Pt1000
• According to IEC 60751	Ni25 ... Ni1000
• Special type	Via special characteristic (max. 30 points)
Sensor factor	0.25 ... 10 (adaptation of the basic type, e.g. Pt100 to version Pt25 ... 1000)
Units	°C or °F
Connection	
• Standard connection	1 resistance thermometer (RTD) in 2-wire, 3-wire or 4-wire connection
• Averaging	2 identical resistance thermometers in 2-wire connection for generation of average temperature
• Differentiation	2 identical resistance thermometers (RTD) in 2-wire connection (RTD 1 – RTD 2 or RTD 2 – RTD 1)
Connection	
• 2-wire connection	Line resistance can be configured $\leq 100 \Omega$ (loop resistance)
• 3-wire connection	No trim necessary
• 4-wire connection	No trim necessary
Sensor current	$\leq 0.45 \text{ mA}$
Response time T_{63}	$\leq 250 \text{ ms}$ for 1 sensor with break monitoring
Break monitoring	Always active (cannot be switched off)
Short-circuit monitoring	Can be switched on/off (default value: ON)
Measuring range	Assignable (see "Digital measuring error" table)
Min. measuring span	10 °C (18 °F)
Characteristic curve	Temperature-linear or special characteristic
Resistance-based sensor	
Measured variable	Actual resistance
Sensor type	Resistance-based, potentiometers
Units	Ω
Connection	
• Standard connection	1 resistance-based sensor (R) in 2-wire, 3-wire or 4-wire connection
• Averaging	2 resistance-based sensors in 2-wire connection for averaging
• Differentiation	2 resistance thermometers in 2-wire connection (R1 – R2 or R2 – R1)
Connection	
• 2-wire connection	Line resistance can be configured $\leq 100 \Omega$ (loop resistance)
• 3-wire connection	No trim necessary
• 4-wire connection	No trim necessary
Sensor current	$\leq 0.45 \text{ mA}$
Response time T_{63}	$\leq 250 \text{ ms}$ for 1 sensor with break monitoring
Break monitoring	Always active (cannot be switched off)
Short-circuit monitoring	Can be switched on/off (default value: OFF)
Measuring range	Assignable max. 0 ... 2200 Ω (see "Digital measuring error" table)
Min. measuring span	5 ... 25 Ω (see "Digital measuring error" table)
Characteristic curve	Resistance-linear or special characteristic

Thermocouples

Measured variable	Temperature
Sensor type (thermocouples)	
• Type B	Pt30Rh-Pt6Rh acc. to IEC 584
• Type C	W5%-Re acc. to ASTM 988
• Type D	W3%-Re acc. to ASTM 988
• Type E	NiCr-CuNi acc. to IEC 584
• Type J	Fe-CuNi acc. to IEC 584
• Type K	NiCr-Ni acc. to IEC 584
• Type L	Fe-CuNi acc. to DIN 43710
• Type N	NiCrSi-NiSi acc. to IEC 584
• Type R	Pt13Rh-Pt acc. to IEC 584
• Type S	Pt10Rh-Pt acc. to IEC 584
• Type T	Cu-CuNi acc. to IEC 584
• Type U	Cu-CuNi acc. to DIN 43710
Units	°C or °F
Connection	
• Standard connection	1 thermocouple (TC)
• Averaging	2 thermocouples (TC)
• Differentiation	2 thermocouples (TC) (TC1 – TC2 or TC2 – TC1)
Response time T_{63}	$\leq 250 \text{ ms}$ for 1 sensor with break monitoring
Break monitoring	Can be switched off
Reference junction compensation	
• Internal	With integrated Pt100 resistance thermometer
• External	With external Pt100 IEC 60751 (2-wire or 3-wire connection)
• External fixed	Reference junction temperature can be set as fixed value
Measuring range	Assignable (see "Digital measuring error" table)
Min. measuring span	Min. 40 ... 100 °C (72 ... 180 °F) (see "Digital measuring error" table)
Characteristic curve	Temperature-linear or special characteristic
mV sensor	
Measured variable	DC voltage
Sensor type	DC voltage source (DC voltage source possible over an externally connected resistor)
Units	mV
Response time T_{63}	$\leq 250 \text{ ms}$ for 1 sensor with break monitoring
Break monitoring	Can be switched off
Measuring range	Assignable max. -100 ... 1100 mV
Min. measuring span	2 mV or 20 mV
Overload capability of the input	-1.5 ... +3.5 V DC
Input resistance	$\geq 1 \text{ M}\Omega$
Characteristic curve	Voltage-linear or special characteristic

Temperature measurement

Temperature transmitters

Rail transmitters

SITRANS TR300 (4 to 20 mA, HART, universal)

Output

Output signal	4 ... 20 mA, 2-wire with communication acc. to HART Rev. 5.9
Auxiliary power	11 ... 35 V DC (to 30 V with Ex i/ic; to 32 V with Ex nA)
Max. load	$(U_{aux} - 11 \text{ V})/0.023 \text{ A}$
Overrange	3.6 ... 23 mA, infinitely adjustable (default range: 3.84 mA ... 20.5 mA)
Error signal (e.g. following sensor fault) (conforming to NE43)	3.6 ... 23 mA, infinitely adjustable (default value: 22.8 mA)
Sample cycle	0.25 s nominal
Damping	Software filter 1st order 0 ... 30 s (parameterizable)
Protection	Against reverse polarity
Galvanic isolation	Input against output 2.12 kV DC (1.5 kV _{rms} AC)

Measuring accuracy

Digital measuring error	See "Digital measuring error" table
Reference conditions	
• Auxiliary power	24 V ± 1 %
• Load	500 Ω
• Ambient temperature	23 °C
• Warming-up time	> 5 min
Error in the analog output (digital/analog converter)	< 0.025 % of measuring span
Error due to internal reference junction	< 0.5 °C (0.9 °F)
Effect of ambient temperature	
• Analog measuring error of measuring span	< 0.02% of max. meas. span/10 °C (18 °F)
• Digital measuring error	0.06 °C (0.11 °F)/10 °C (18 °F)
- With resistance thermometers	0.6 °C (1.1 °F)/10°C (18 °F)
- With thermocouples	
Auxiliary power effect	< 0.001 % of meas. span/V
Effect of load impedance	< 0.002 % of meas. span/100 Ω
Long-term drift	
• In the first month	< 0.02 % of measuring span
• After one year	< 0.2 % of measuring span
• After 5 years	< 0.3 % of measuring span

Rated conditions

Ambient conditions

Ambient temperature	-40 ... +85 °C (-40 ... +185 °F)
Storage temperature	-40 ... +85 °C (-40 ... +185 °F)
Relative humidity	< 98 %, with condensation
Electromagnetic compatibility	According to EN 61326 and NE21

Design

Material	Plastic, electronic module potted
Weight	122 g
Dimensions	See "Dimensional drawings"
Cross-section of cables	Max. 2.5 mm ² (AWG 13)
Degree of protection according to IEC 60529	
• Enclosure	IP20

Certificates and approvals

Explosion protection ATEX	
EC type-examination certificate	PTB 07 ATEX 2032X
• "Intrinsic safety" type of protection	II 2(1) G Ex ia/ib IIC T6/T4 II 3(1) G Ex ia/ic IIC T6/T4 II 3 G Ex ic IIC T6/T4 II 2(1) D Ex iaD/ibD 20/21 T115 °C II 3 G Ex nA IIC T6/T4
• "Non-sparking equipment" type of protection	
Other certificates	EAC Ex(GOST) and NEPSI

Factory setting:

- Pt100 (IEC 751); 3-wire connection
- Measuring range: 0 ... 100 °C (32 ... 212 °F)
- Fault current: 22.8 mA
- Sensor offset: 0 °C (0 °F)
- Damping 0.0 s

Digital measuring errorResistance thermometer

Input	Measuring range	Minimum measuring span		Digital accuracy	
		°C (°F)	°C (°F)	°C (°F)	°C (°F)
According to IEC 60751					
Pt25	-200 ... +850 (-328 ... +1562)	10	(18)	0.3	(0.54)
Pt50	-200 ... +850 (-328 ... +1562)	10	(18)	0.15	(0.27)
Pt100 ... Pt200	-200 ... +850 (-328 ... +1562)	10	(18)	0.1	(0.18)
Pt500	-200 ... +850 (-328 ... +1562)	10	(18)	0.15	(0.27)
Pt1000	-200 ... +350 (-328 ... +662)	10	(18)	0.15	(0.27)
According to JIS C1604-81					
Pt25	-200 ... +649 (-328 ... +1200)	10	(18)	0.3	(0.54)
Pt50	-200 ... +649 (-328 ... +1200)	10	(18)	0.15	(0.27)
Pt100 ... Pt200	-200 ... +649 (-328 ... +1200)	10	(18)	0.1	(0.18)
Pt500	-200 ... +649 (-328 ... +1200)	10	(18)	0.15	(0.27)
Pt1000	-200 ... +350 (-328 ... +662)	10	(18)	0.15	(0.27)
Ni 25 ... Ni1000	-60 ... +250 (-76 ... +482)	10	(18)	0.1	(0.18)

Resistance-based sensor

Input	Measuring range	Minimum measuring span	Digital accuracy
Resistance	0 ... 390	5	0.05
Resistance	0 ... 2200	25	0.25

Thermocouples

Input	Measuring range	Minimum measuring span		Digital accuracy	
		°C (°F)	°C (°F)	°C (°F)	°C (°F)
Type B	100 ... 1820 (212 ... 3308)	100	(180)	2 ¹⁾	(3.6) ¹⁾
Type C (W5)	0 ... 2300 (32 ... 4172)	100	(180)	2	(3.6)
Type D (W3)	0 ... 2300 (32 ... 4172)	100	(180)	1 ²⁾	(1.8) ²⁾
Type E	-200 ... +1000 (-328 ... +1832)	50	(90)	1	(1.8)
Type J	-200 ... +1200 (-328 ... +2192)	50	(90)	1	(1.8)
Type K	-200 ... +1370 (-328 ... +2498)	50	(90)	1	(1.8)
Type L	-200 ... +900 (-328 ... +1652)	50	(90)	1	(1.8)
Type N	-200 ... +1300 (-328 ... +2372)	50	(90)	1	(1.8)
Type R	-50 ... +1760 (-58 ... +3200)	100	(180)	2	(3.6)
Type S	-50 ... +1760 (-58 ... +3200)	100	(180)	2	(3.6)
Type T	-200 ... +400 (-328 ... +752)	40	(72)	1	(1.8)
Type U	-200 ... +600 (-328 ... +1112)	50	(90)	2	(3.6)

¹⁾ The digital accuracy in the range 100 to 300 °C (212 to 572 °F) is 3 °C (5.4 °F).

²⁾ The digital accuracy in the range 1750 to 2300 °C (3182 to 4172 °F) is 2 °C (3.6 °F).

mV sensor

Input	Measuring range	Minimum measuring span	Digital accuracy
mV sensor	-10 ... +70	2	40
mV sensor	-100 ... +1100	20	400

The digital accuracy is the accuracy after the analog/digital conversion including linearization and calculation of the measured value.

An additional error is generated in the output current 4 to 20 mA as a result of the digital/analog conversion of 0.025% of the set measuring span (digital-analog error).

The total error under reference conditions at the analog output is the sum from the digital error and the digital-analog error (poss. with the addition of reference junction errors in the case of thermocouple measurements).

Temperature measurement

Temperature transmitters

Rail transmitters

SITRANS TR300 (4 to 20 mA, HART, universal)

Selection and ordering data

	Article No.
SITRANS TR300 rail transmitter Installation on mounting rail 2-wire system, 4 ... 20 mA, HART, with galvanic isolation	
• Without explosion protection	7NG3033-0JN00
• With explosion protection according to ATEX	7NG3033-1JN00
Options	Order code
Append suffix "-Z" to article no., add order code and plain text, if applicable.	
With test report (5 measuring points)	C11
Functional safety SIL2	C20
Functional safety SIL2/3	C23
Customer-specific programming	
Measuring range to be set	Y01¹⁾
Specify in plain text (max. 5 digits): Y01:... to ... °C, °F	
Measuring point number (TAG) max. 8 characters	Y17²⁾
Measuring point description, max. 16 characters	Y23²⁾
Measuring point message, max. 32 characters	Y24²⁾
Text on front plate, max. 16 characters	Y29²⁾³⁾
Pt100 (IEC) 2-wire, $R_L = 0 \Omega$	U02⁴⁾
Pt100 (IEC) 3-wire	U03⁴⁾
Pt100 (IEC) 4-wire	U04⁴⁾
Type B thermocouple	U20⁴⁾⁵⁾
Type C thermocouple (W5)	U21⁴⁾⁵⁾
Type D thermocouple (W3)	U22⁴⁾⁵⁾
Type E thermocouple	U23⁴⁾⁵⁾
Type J thermocouple	U24⁴⁾⁵⁾
Type K thermocouple	U25⁴⁾⁵⁾
Type L thermocouple	U26⁴⁾⁵⁾
Type N thermocouple	U27⁴⁾⁵⁾
Type R thermocouple	U28⁴⁾⁵⁾
Type S thermocouple	U29⁴⁾⁵⁾
Type T thermocouple	U30⁴⁾⁵⁾
Type U thermocouple	U31⁴⁾⁵⁾
For TC: Cold junction compensation: external (Pt100, 3-wire)	U41
For TC: Cold junction compensation: external with fixed value: specify in plain text	Y50
Enter special deviating customer-specific setting in plain text	Y09⁶⁾
Fault current 3.6 mA (instead of 22.8 mA)	U36²⁾

- 1) For customer-specific programming for RTD and TC, the start value and the end value of the required measuring span must be specified here.
- 2) For this selection, Y01 or Y09 must also be selected.
- 3) Text on front plate is not saved in the device.
- 4) For this selection, Y01 must also be selected.
- 5) Internal reference junction compensation is selected as the default for TC.
- 6) For customer-specific programming for mV and ohm, the start value and the end value of the required measuring span and the unit must be entered here.

Accessories

	Article No.
Additional accessories for assembly, connection and transmitter configuration, see page 2/251.	
Modem	
Modem with USB interface	7MF4997-1DB
SIMATIC PDM operating software	See section 8

For supply units, see Catalog FI01 section "Supplementary components"

Ordering example 1:

7NG3033-0JN00-Z Y01+Y17+Y29+U03

Y01: -10 ... +100 °C

Y17: TICA123

Y29: TICA123

Ordering example 2:

7NG3033-0JN00-Z Y01+Y17+Y23+Y29+U25

Y01: -10 ... +100 °C

Y17: TICA123

Y23: TICA123HEAT

Y29: TICA123HEAT

Factory setting:

- Pt100 (IEC 751); 3-wire connection
- Measuring range: 0 ... 100 °C (32 ... 212 °F)
- Fault current in the event of sensor breakage: 22.8 mA
- Sensor offset: 0 °C (0 °F)
- Damping 0.0 s

Dimensional drawings

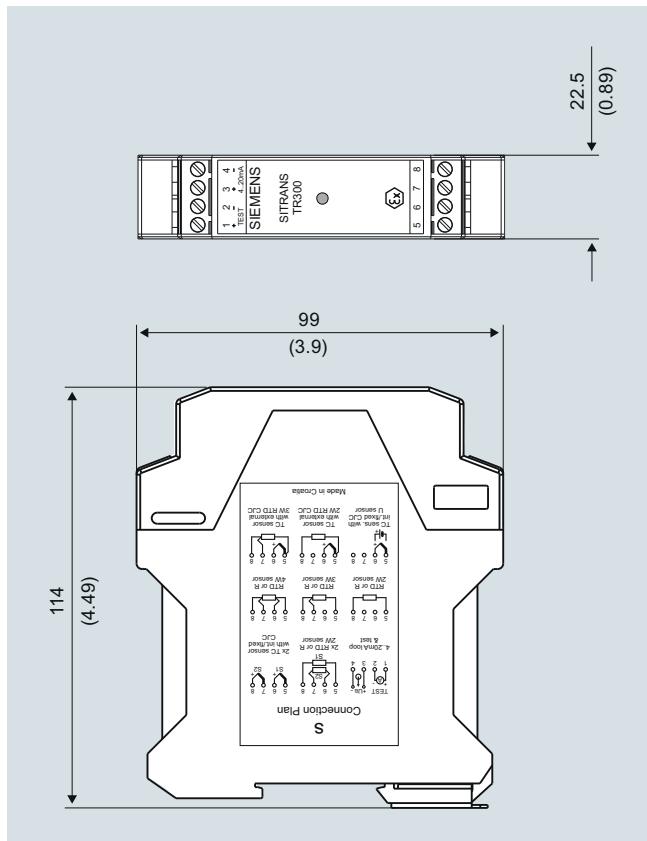

SITRANS TR300, dimensions in mm (inch)

Circuit diagrams

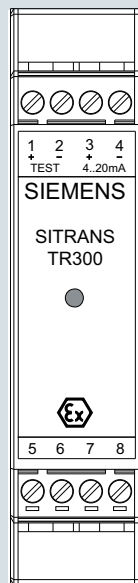

Connections

- 1 (+) and 2 (-) Test terminals (Test) for measurement of the output current with a multimeter
- 3 (+) and 4 (-) Power supply U_{aux} , Output current I_{out}
- 5, 6, 7 and 8 Sensor connection, see schematics

SITRANS TR300, connector assignment

Temperature measurement

Temperature transmitters

Rail transmitters

SITRANS TR300 (4 to 20 mA, HART, universal)

2

Resistance thermometer

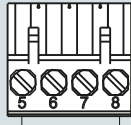

2-wire system ¹⁾

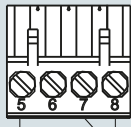

3-wire system

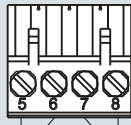

4-wire system

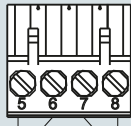

Generation of average value/difference ¹⁾

¹⁾ Programmable line resistance for the purpose of correction.

Resistance

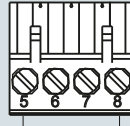

2-wire system ¹⁾

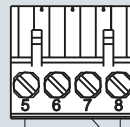

3-wire system

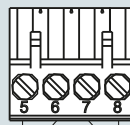

4-wire system

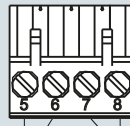

Generation of average value/difference ¹⁾

Thermocouple

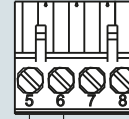

Cold junction compensation internal/fixed value

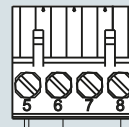

Cold junction compensation with external Pt100 in 2-wire system ¹⁾

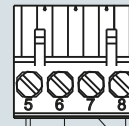

Cold junction compensation with external Pt100 in 3-wire system

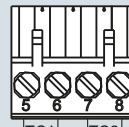

Generation of average value / difference with internal cold junction compensation

Voltage measurement

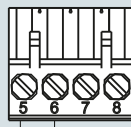

Current measurement

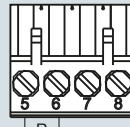

Test terminals

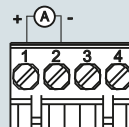

Power supply/ 4 ... 20 mA (U_{aux})

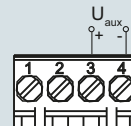

SITRANS TR300, sensor connection assignment