



Connection Solutions

for Food Machinery and Process Applications

Push-In Fittings, Tubing, Function Fittings, Couplers, Accessories



ENGINEERING YOUR SUCCESS.

Content

Fittings Adapted to Each Zone of the Food Process Industry

4

Our Solution for Each Food Zone Area

6

1 & 2
Robust products conveying any type of fluid, corrosion-resistant, safe, and easy to clean.

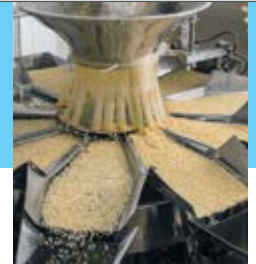

Our Solution for the Splash Zone

10

3
Robust products, resistant to corrosion and mechanical constraints.



Our Solution for the Non Food Zone

12

4
Products with high performance pressure and temperature capability.



LIQUIfit®, Solutions for fluids & Beverages

14

Our new range for the transportation of water, beverages and other consumable liquids.



High quality products, innovative solutions and an international presence.



A complete range of pneumatic products meeting the requirements of food processing and packaging applications.

Fittings Adapted to Each Zone of the Food Process Industry

Parker Legris is committed to developing wide ranges of robust pneumatic components that are chemically resistant and easy to clean.

Our offer perfectly suits each food process zone, enabling the manufacture of machinery and equipment which meet current standards.



Food Zone



CHARACTERISTICS OF THE ZONE

Surfaces in contact with foodstuffs or where there can be a risk of projection or migration of materials into the manufacturing process.

1&2

- 1 - Fluid and food
- 2 - Air, vacuum and water

REQUIREMENTS FOR PNEUMATIC COMPONENTS

- High hygienic standards: materials and shapes suitable for use with foodstuffs.
- Aggressive cleaning agents: non-corrosive, non-toxic and non-absorbent materials.
- Mechanical strength during use or when cleaning: a robust product.

OUR PRODUCT ANSWER

A wide and complete range of robust stainless steel products, manufactured in accordance with HACCP methodology (Hazard Analysis Critical Control Point). Fittings with a hygienic design, easy to clean for permanent contact with food, conforming to FDA and 1935/2004/EC standards.

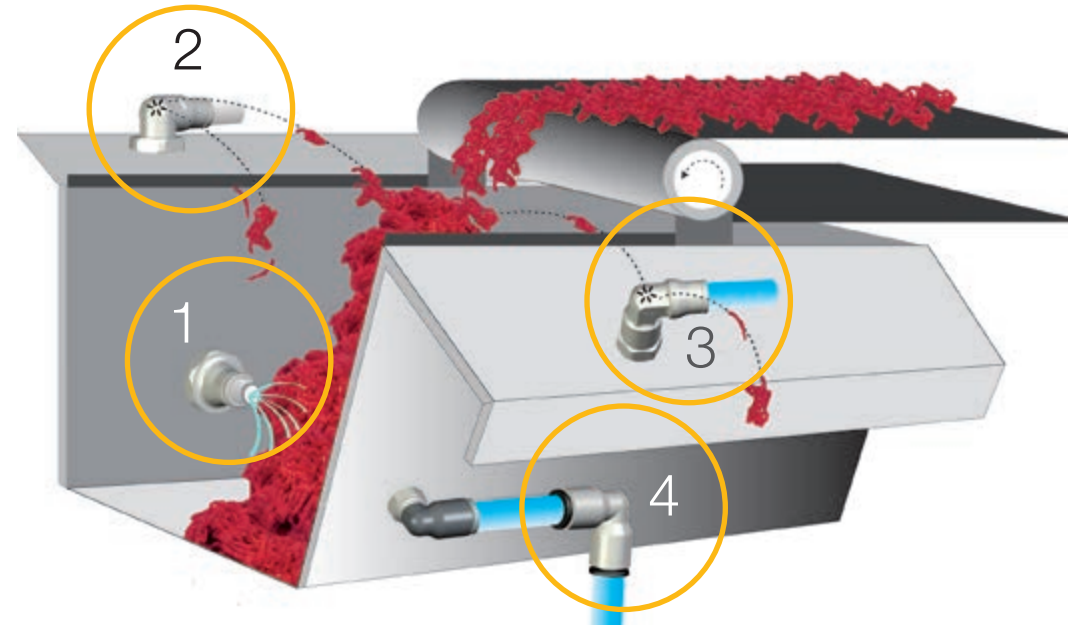

Splash Zone



CHARACTERISTICS OF THE ZONE

Surfaces subject to the projection of food, but with limited potential return to the manufacturing process.

3

- 3 - Air, water and vacuum

REQUIREMENTS FOR PNEUMATIC COMPONENTS

- High hygienic standards: materials and shapes suitable for use with foodstuffs.
- Aggressive cleaning agents: slightly corrosive, non-toxic and non-absorbent materials.
- Mechanical strength during use or when cleaning: a robust product.

OUR PRODUCT ANSWER

A wide range of high phosphorus bonded nickel-plated brass fittings, compatible with many aggressive fluids. A quick connecting, reliable and safe gripping system, extremely resistant to high pressures, temperatures and shocks.



Non-Food Zone



CHARACTERISTICS OF THE ZONE

Surfaces which are not in contact with food.

4

- 4 - Air and vacuum

REQUIREMENTS FOR PNEUMATIC COMPONENTS

- High pressures and temperatures: technical performance of components.
- Quick, reliable and safe connection / disconnection.
- Frequent cleaning: less corrosive materials.

OUR PRODUCT ANSWER

An extensive range of polymer fittings, with high mechanical and chemical resistance, optimized dimensions and body designs to satisfy the ergonomics and aesthetics of pneumatic installations. A quick connecting, reliable and safe gripping system, extremely resistant to high pressures, temperatures and shocks.



Our Solution for the Food Zone



STAINLESS STEEL INSTANT FITTINGS

FDA

316 L / FKM SEALS

THREADED FITTINGS	TUBE TO TUBE FITTINGS
3805 / 3801 taper and parallel	3806 Ø4 to Ø12
3821 / 3831 taper and parallel	3816 IP51 Ø4 to Ø12
3809 / 3899 taper and parallel	3802 Ø4 to Ø12
3889 / 3879 taper and parallel	3804 Ø4 to Ø12
	PLUG-IN FITTINGS
	3866 Ø4 to Ø10
	CARTRIDGES
	3800 Ø4 to Ø12

ACCESSORIES

EQUAL ELBOWS	ADAPTORS	COMPACT SILENCER
1843 female parallel	1864 male NPT, female parallel	0682 parallel
1844 male taper, female parallel	1867 male taper, female NPT	PLUGS
BULKHEAD ADAPTOR	REDUCERS	0285 taper
1817 parallel	1863 male taper, female parallel	FLUOROPOLYMER TAPE
	INCREASERS	0605
SLEEVES	1861 male taper, female parallel	STAINLESS STEEL FERRULES
1855 parallel	PLUG-IN FITTINGS	1827 Ø4 to Ø14
1862 Reducer - Increaser parallel	3826	
1823 Tailpiece adaptor taper		

TUBING

FDA

CALIBRATED FEP(3)	ADVANCED POLYETHYLENE
1005T 1025T	1015Y..F 1030Y..F 1075Y..F 1096Y..F 1098Y..F
PFA	CRYSTAL POLYETHER POLYURETHANE(2)
1050T..P 1100T..P	1025U..R 1100U..R

TUBING

External Diameters:
Ø4 to Ø16

ACCESSORIES

Working Pressure: 150 bar maximum (silencers: 12 bar)
Temperature Range: -20°C to +180°C
Available Threads: 1/8" to 1"

INSTANT FITTINGS

Working Pressure: 30 bar maximum
Vacuum: 99%
Temperature Range: -25°C to +150°C
Available Diameters: Ø4 to Ø12 mm
Available Threads: M5 to 1/2"

FUNCTION FITTINGS 316 L (1)

FLOW CONTROL REGULATORS	QUICK EXHAUST VALVES WITH THREADED FITTINGS	NON-RETURN VALVES WITH THREADED FITTINGS
7810 parallel	7899 parallel	4890 parallel
7820 parallel		4891 parallel
		4892 parallel

FUNCTION FITTINGS

Flow control regulators: Working Pressure: 1 to 10 bar / 1 to 16 bar (7820)
Temperature Range: 0°C to +70°C / -15°C to 120°C (7820)
Available Threads: M5 to 1/2"

Exhaust valves: Working Pressure: 2 to 10 bar
Temperature Range: -10°C to +120°C (1/8 and 1/4) or -20°C to +80°C (3/8 and 1")
Available threads: 1/8 to 1"

Non-return valves: Working Pressure: 0,5 to 40 bar
Temperature Range: -20°C to +180°C
Available Threads: 1/8 to 1"

STAINLESS STEEL BALL VALVES

4812 parallel
4832 parallel
0591 parallel
4810 parallel
0465 parallel

BALL VALVES

Internal Ø :
4 to 50 mm
Threads :
1/4" to 2"

STAINLESS STEEL COUPLERS 316 L

FDA

FKM FDA SEALS	FKM FDA SEALS	FKM FDA SEALS
Series 20KA	Series 21KA	Series 25KA
Single shut off	Single shut off	Single shut off
20KAW parallel male body	21KAW parallel male body	25KAW parallel male body
20KAIW parallel female body	21KAIW parallel female body	25KAIW parallel female body
20SFAW parallel male probe	21SFAW parallel male probe	25SFAW parallel male probe
20SFIW parallel female probe	21SFIW parallel female probe	25SFIW parallel female probe
Ø INTERNAL 2,7 mm	Ø INTERNAL 5 mm	Ø INTERNAL 7,4 mm

COUPLERS

Working Pressure: 35 bar maximum
Temperature Range: -15°C to +200°C
Threads: M5 to 1/2"
Single or double shut-off

Find all the technical characteristics of these products on our website www.parkerlegris.com
From the «Low pressure» menu, enter the reference for each item and access full details: technical data, dimensions, certificates, CAD drawings.



Stainless Steel Fittings LF 3800



A range of stainless steel instant fittings combining robustness and hygienic design

The Largest Range on the Market

- Designed for demanding conditions of use: a range of instant fittings in full 316L stainless steel with FKM seals, for basic chemical resistance and a competitive price positioning
- 17 different product body shapes, diameters from 4mm to 12mm, threads from M5 to 1/2"
- 2 thread types: taper and parallel

Reliable and Robust Design

- Proven gripping technology:
 - the collet guarantees excellent gripping and improved pull-out strength for soft and stainless steel tubing
 - the collet is resistant to mechanical shocks and prevents whiplash, in particular when using metallic (pre-grooved) tubing
- Simple and reliable design
- 100 % control of manufactured components in order to guarantee quality, traceability and performance
- FKM seal resistant to the majority of aggressive chemicals
- Pressure rating: 30 bar, temperature capability: 150°C, continuous (For higher temperatures, please contact our technical department)
- Sealed bulkhead connectors (to IP55) enabling complete protection against detrimental ingress in food and non-food zones

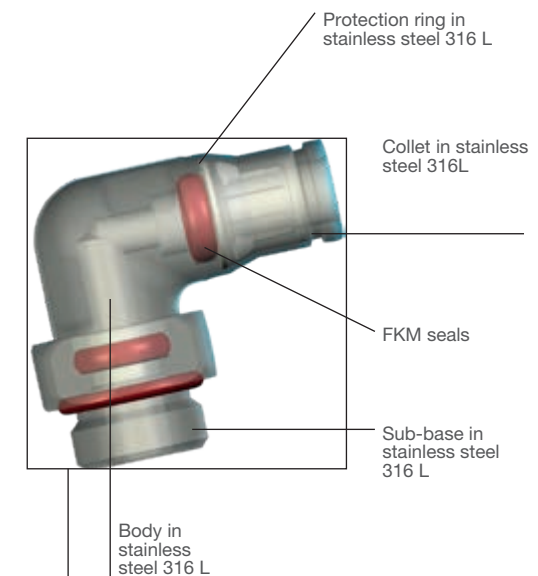

Hygienic Design

- Nutrient grade materials conforming to FDA and 1934/2004 EC standards, permitting permanent contact with food.
- A permissible all metal product, preventing the risk of non-detection of misplaced components.
- A very smooth surface design aimed at reducing retention zones for safe and easy cleaning :

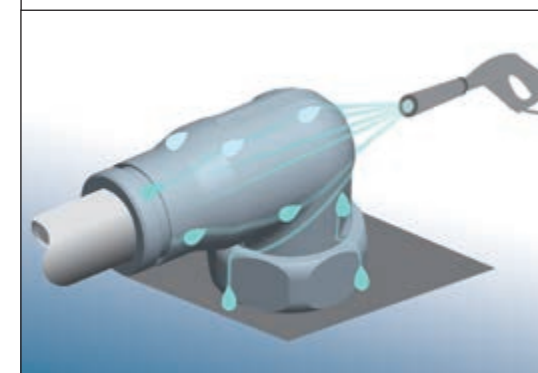
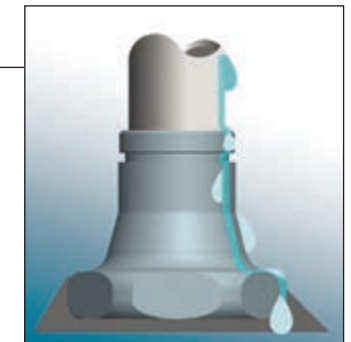

- Compact fittings with a polished surface for improved cleaning
- Self-draining design naturally ensures the dispersion of external fluids
- Ra < 0,8 surface prevents food deposits from adhering to body
- Minimum space between release button and body of fitting
- Aerodynamic body shape, without dead zones or fixing holes, for improved and faster fluid pressure cleaning
- A range of parallel sub-bases, reducing potential retention zones

Our Solution for the Splash Zone



NICKEL-PLATED BRASS INSTANT FITTINGS ⁽¹⁾			FUNCTION FITTINGS 316L ⁽¹⁾		NICKEL-PLATED BRASS FUNCTION FITTINGS		NICKEL-PLATED BRASS ACCESSORIES		TUBING		NICKEL-PLATED BRASS BALL VALVES		NICKEL-PLATED BRASS COUPLERS
FDA			FDA		FDA		FDA		FDA		FDA		FDA
THREADED FITTINGS	THREADED FITTINGS	TUBE TO TUBE FITTINGS	FLOW REG. WITH ADJUSTMENT SCREW	NON-RETURN VALVES	FLOW REGULATORS WITH INSTANT FITTINGS	BLOCKING FITTINGS WITH INSTANT CONNECTIONS	EQUAL ELBOWS	EQUAL Y	CALIBRATED FEP⁽³⁾	ADVANCED POLYETHYLENE	STRAIGHT FLUOROPOLYMER SERIES	STRAIGHT UNIVERSAL SERIES	FKM SEALS
3675 taper 3601 parallel and metric 3681 metric 3614 parallel and metric 3609 taper 3699 parallel and metric 3608 taper	3698 parallel and metric BANJO FITTINGS 3618 parallel and metric 3606 parallel and metric 3602 parallel and metric 3604 parallel and metric	3616 IP51 Ø4 to Ø14 3639 parallel and metric Ø4 to Ø14 3600 parallel and metric Ø4 to Ø14 3622 parallel and metric Ø4 to Ø14 3626 parallel and metric Ø4 to Ø14	7810 parallel 7820 parallel QUICK EXHAUST VALVES 7899 parallel	4890 parallel 4891 parallel 4892 parallel	7100 parallel 7130 parallel and metric 7680 parallel 7170 parallel	7880 parallel EXHAUST VALVES WITH THREADED FITTINGS 7970 parallel 7971 male taper female parallel	0912 female parallel and metric 0913 male taper / female parallel 0921 female metric EQUAL TEE 0915 parallel and metric 0916 male taper / female parallel 0923 metric	0911 male taper / female parallel EQUAL CROSSES 0908 parallel ADAPTOR 0192 double male taper / parallel PLUGS⁽⁴⁾ 0919 parallel and metric	1005T 1025T CRYSTAL POLYETHER POLYURETHANE⁽²⁾ 1025U..R 1100U..R	1015Y..F 1030Y..F 1075Y..F 1096Y..F 1098Y..F BRAIDED PVC	4902 parallel	0402 parallel 0401 parallel 0482 parallel 0452 parallel 0439 parallel	Series 20 / 21 / 25KA single shut-off 21KAAW male parallel body 21KAIW female parallel body 21SFAW male parallel probe 21SFIW female parallel probe Ø INTERNAL Series 20 2,7 mm Series 21 5 mm Series 25 7,4 mm
INSTANT FITTINGS Working Pressure: 20 bar maximum Vacuum: 99% Temperature Range: -25°C to +150°C Available Diameters: Ø4 to Ø14 mm Available Threads: M5 to 1/2			FUNCTION FITTINGS Flow control regulators : Working Pressure: 1 to 10 bar Temperature Range: 0°C to +70°C Available Diameters: Ø4 to Ø12 Available Threads: M5, 1/8" to 1/2" Blocking fittings : Working Pressure: 1 to 10 bar Temperature Range: -20°C to +70°C Available Diameters: Ø4 to Ø12 Available Threads: 1/8" to 1/2" Exhaust valves: Working Pressure: 0,7 to 10 bar (7870) 2 to 10 bar (7871) Temperature Range: -20°C to +70°C Available Threads: M5, 1/8 to 1" Exhaust valves 316L: Working Pressure: 2 to 10 bar Temperature Range: -10°C to +120°C (1/8" to 1/4") or -20°C to +180°C (3/8" et 1") Available Threads: M5, 1/8" à 1" Non-Return Valves: Working Pressure: 0,5 to 40 bar Temperature Range: -20°C to +180°C Available Threads: 1/8" to 1"		ACCESSORIES Working pressure: 60 bar maximum Temperature range: -10°C to +150°C Available threads: M5 to 3/4		TUBING External diameters: Ø4 to Ø16		BALL VALVES Fluoropolymer series: Working pressure: 25 to 30 bar Temperature range: -20°C to +130°C Internal diameter: 10 to 100 mm Available threads: 1/4 to 4" Straight universal series: Working pressure: 20 to 40 bar Temperature range: -20°C to +80°C Internal diameter 4 to 40 mm Available threads: 1/8 to 2"		COUPLERS Working pressure: 35 bar Temperature range: -20°C to +100°C Available threads: M5 to 1/2"		

























⁽¹⁾ Not suitable for permanent contact with food.
⁽²⁾ Authorised for contact with dry or temporarily moist food (10 minutes maximum).
⁽³⁾ Authorized for contact with food, but sensitive to very aggressive chemical cleaning agents.
⁽⁴⁾ Maximum 80°C.

Find all the technical characteristics of these products on our website www.parkerconnect.com
 From the «Low pressure» menu, enter the reference for each item and access full details: technical data, dimensions, certificates, CAD drawings.













Our Solution for the Non Food Zone







POLYMER INSTANT FITTINGS						
THREADED FITTINGS	MALE STUD ELBOWS	TEES	TUBE TO TUBE FITTINGS	BANJO FITTINGS	CARTRIDGES	PLUG-IN ACCESSORIES
 3175 taper	 3109 taper	 3108 taper	 3106 Ø3 to Ø14	 3118 parallel and metric	 3100 Ø4 to Ø12	 3182 Ø4 to Ø12
 3101 parallel and metric	 3129 taper	 3103 taper	 3102 Ø4 to Ø14			 3188 Ø4 to Ø12
 3181 metric	 3113 taper	 3198 parallel and metric	 3104 Ø3 to Ø14			 3126 Ø3 to Ø14
 3114 parallel and metric	 3199 parallel and metric	 3193 parallel and metric	 3140 Ø4 to Ø12			 3151 Ø4 to Ø12
			 3144 Ø4 to Ø6			
			BULKHEAD TUBE TO TUBE FITTINGS			
			 3116 Ø4 to Ø14			



INSTANT FITTINGS
Working Pressure: 20 bar maximum Vacuum: 99% Temperature Range: -20°C to +80°C Available Diameters: Ø3 to Ø14mm Available Threads: M3, M5, 1/8 to 1/2









POLYMER FUNCTION FITTINGS		
FLOW REGULATORS WITH INSTANT FITTINGS	BLOCKING FITTINGS WITH INSTANT CONNECTIONS	NON-RETURN VALVES
 7010 parallel	 7883 parallel	 7996 double union Ø4 to Ø12
 7060 parallel	PILOTED NON-RETURN VALVES	 7984 parallel and metric
 7040 parallel	 7894 parallel	 7985 taper
 7770 in-line		
 7030 plug-in		

FUNCTION FITTINGS
Working Pressure: 1 to 10 bar Temperature Range: 0°C to +70°C Available Diameters: Ø4 to Ø12 Available Threads: M3 to 1/2

TUBING
SEMI-RIGID POLYAMIDE  1025P 1100P
FLEXIBLE POLYESTER POLYURETHANE  1025U 1100U
POLYETHER POLYURETHANE BLACK, BLUE  1025U..R 1100U..R
ADVANCED POLYETHYLENE  1015Y..F 1030Y..F 1075Y..F 1096Y..F 1098Y..F

TUBING
External Diameters: Ø3 to Ø16

NICKEL-PLATED BRASS BALL VALVES	
 0492 parallel	
 0491 parallel	
VANNES A PURGE  0669 parallel	

NICKEL-PLATED BRASS COUPLERS	SAFETY COUPLERS
SERIES 23 / 24 / 30  23KAAK male parallel body	 9401U male parallel body
 23KAIW female parallel body	 9414U female parallel body
 23SFAK male parallel probe	 9087U male parallel probe
 23SFIW female parallel probe	 9086U female parallel probe

COUPLERS
Working Pressure: 35 bar / 16 bar (safety couplers) Temperature Range: -20°C to +100°C / -20°C to +60°C (safety couplers) Available Threads: 1/4 to 1/2

BALL VALVES
Working Pressure: 12 bar maximum Temperature Range: -20°C to +80°C Internal Diameter: 4 to 13 mm Available Threads: 1/4 to 3/4

Find all the technical characteristics of these products on our website www.parkerlegris.com
 From the «Low pressure» menu, enter the reference for each item and access full details: technical data, dimensions, certificates, CAD drawings.



LIQUIfit® , Connection Solutions for Beverage & Fluids

LIQUIfit® Push-In Fittings

This "eco-designed" range proposes an **innovative alternative** for water applications; **no fluid contamination** occurs and **environmental protection is guaranteed**. These fittings ensure **reliable and compact** connections for **liquid transfer** applications.



Product Advantages

Innovative Technology & Concept

Ergonomic and aesthetic design
The most compact product on the market for water, beverages and liquid foodstuffs
Easy-to-clean external surfaces
Push-in connection and disconnection
Full flow
Use with a pre-prepared metallic tubing
Gripping system preventing any pumping effect
Eco-designed (materials, manufacturing process, weight, dimensions and performance)

Optimal Performance

Patented sealing technology
100% leak-tested in production
Date coding to guarantee quality and traceability
Wide range of shapes and numerous configurations

High Performance Material

Bio-sourced polymer meeting the most severe food process regulations
Suitable for contact with water and beverages
Excellent chemical and mechanical resistance, even at high temperature
Free of bisphenol A and phthalates, conforming with regulations



Hot & Cold Drinks Dispensers
Neutral Gases
Cooling Systems
Food Process
Water Purification Systems
Water Dispensers
Medical

Applications

LIQUIfit® Push-In Fittings with Metal Adaptors

The LIQUIfit® range now benefits from a range extension of **metal adaptors** designed for **liquid transfer applications**. These fittings ensure **reliable** and **compact** connections combined with **excellent robustness**.

Product Advantages

Innovative Technology & Concept

Ergonomic and aesthetic design
Compact product for water applications
Easy-to-clean external surfaces
Full flow
Use with a pre-prepared metallic tubing
Gripping system preventing any pumping effect

Optimal Performance

Patented sealing technology
100% leak-tested in production
Date coding to guarantee quality and traceability
Wide range of shapes and numerous configurations
Excellent robustness for a long lifespan

High Performance Material

Bio-sourced polymer body meeting the most severe food process regulations
Compatibility with beverages (stainless steel version)
Unsurpassed chemical and mechanical resistance, even at high temperatures
Free of bisphenol A and phthalates, conforming with regulations



Industrial Fluids
Beverage Process
Inert Gases
Cooling Systems
Food Process

Applications

Technical Characteristics

Compatible Fluids	Water, beverages, CO ₂ (inert use) Chemical fluids: please consult us		
Working Pressure	Vacuum to 16 bar		
Working Temperature	-10°C to +95°C		
Tightening Torques (BSPT/NPTF)	Thread	1/8" and 1/4"	3/8" and 1/2"
	daN.m	0.15	0.30

Reliable performance is dependent upon the type of fluid conveyed, component materials and tubing being used.
Use is guaranteed with a vacuum of 755 mm Hg (99% vacuum).

Component Materials



Silicone-free

Regulations

DI: 2002/95/EC (RoHS), 2011/65/EC	DM 174
RG: 1935/2004/EC	WRAS
FDA: 21 CFR	ACS
NSF 51 at 95°C	RG: 1907/2006 (REACH)
NSF/ANSI 61 - C HOT	KTW
	W270

Technical Characteristics

Compatible Fluids	Water, beverages, industrial fluids: stainless steel threads					
	Industrial fluids: FDA chemical nickel-plated brass threads					
Working Pressure	Vacuum to 16 bar					
Working Temperature	-10°C to +95°C					
Tightening Torques (BSPP)	Thread	M5 X0.8	G1/8	G1/4	G3/8	G1/2
	daN.m	0.16	0.8	1.2	3	3.5

Reliable performance is dependent upon the type of fluid conveyed, component materials and tubing being used.
Use is guaranteed with a vacuum of 755 mm Hg (99% vacuum).

Component Materials

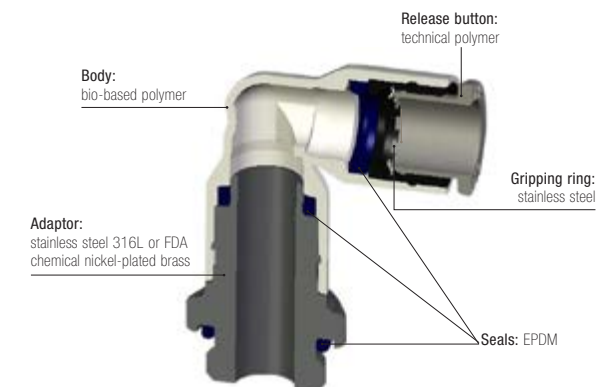

Silicone-free

Regulations

DI: 2002/95/EC (RoHS), 2011/65/EC
RG: 1935/2004/EC
FDA: 21 CFR
KTW (stainless steel only)
W270 (stainless steel only)

Parker Worldwide

Europe, Middle East, Africa

AE – United Arab Emirates,

Dubai
Tel: +971 4 8127100
parker.me@parker.com

AT – Austria, Wiener Neustadt

Tel: +43 (0)2622 23501-0
parker.austria@parker.com

AT – Eastern Europe, Wiener

Neustadt
Tel: +43 (0)2622 23501 900
parker.easteurope@parker.com

AZ – Azerbaijan, Baku

Tel: +994 50 2233 458
parker.azerbaijan@parker.com

BE/LU – Belgium, Nivelles

Tel: +32 (0)67 280 900
parker.belgium@parker.com

BG – Bulgaria, Sofia

Tel: +359 2 980 1344
parker.bulgaria@parker.com

BY – Belarus, Minsk

Tel: +48 (0)22 573 24 00
parker.poland@parker.com

CH – Switzerland, Etoy

Tel: +41 (0)21 821 87 00
parker.switzerland@parker.com

CZ – Czech Republic, Klecany

Tel: +420 284 083 111
parker.czechrepublic@parker.com

DE – Germany, Kaarst

Tel: +49 (0)2131 4016 0
parker.germany@parker.com

DK – Denmark, Ballerup

Tel: +45 43 56 04 00
parker.denmark@parker.com

ES – Spain, Madrid

Tel: +34 902 330 001
parker.spain@parker.com

FI – Finland, Vantaa

Tel: +358 (0)20 753 2500
parker.finland@parker.com

FR – France, Contamine s/Arve

Tel: +33 (0)4 50 25 80 25
parker.france@parker.com

GR – Greece, Piraeus

Tel: +30 210 933 6450
parker.greece@parker.com

HU – Hungary, Budaörs

Tel: +36 23 885 470
parker.hungary@parker.com

IE – Ireland, Dublin

Tel: +353 (0)1 466 6370
parker.ireland@parker.com

IL – Israel

Tel: +39 02 45 19 21
parker.israel@parker.com

IT – Italy, Corsico (MI)

Tel: +39 02 45 19 21
parker.italy@parker.com

KZ – Kazakhstan, Almaty

Tel: +7 7273 561 000
parker.easteurope@parker.com

NL – The Netherlands, Oldenzaal

Tel: +31 (0)541 585 000
parker.nl@parker.com

NO – Norway, Asker

Tel: +47 66 75 34 00
parker.norway@parker.com

PL – Poland, Warsaw

Tel: +48 (0)22 573 24 00
parker.poland@parker.com

PT – Portugal

Tel: +351 22 999 7360
parker.portugal@parker.com

RO – Romania, Bucharest

Tel: +40 21 252 1382
parker.romania@parker.com

RU – Russia, Moscow

Tel: +7 495 645-2156
parker.russia@parker.com

SE – Sweden, Spånga

Tel: +46 (0)8 59 79 50 00
parker.sweden@parker.com

SK – Slovakia, Banská Bystrica

Tel: +421 484 162 252
parker.slovakia@parker.com

SL – Slovenia, Novo Mesto

Tel: +386 7 337 6650
parker.slovenia@parker.com

TR – Turkey, Istanbul

Tel: +90 216 4997081
parker.turkey@parker.com

UA – Ukraine, Kiev

Tel: +48 (0)22 573 24 00
parker.poland@parker.com

UK – United Kingdom, Warwick

Tel: +44 (0)1926 317 878
parker.uk@parker.com

ZA – South Africa, Kempton Park

Tel: +27 (0)11 961 0700
parker.southafrica@parker.com

North America

CA – Canada, Milton, Ontario

Tel: +1 905 693 3000

US – USA, Cleveland

Tel: +1 216 896 3000

Asia Pacific

AU – Australia, Castle Hill

Tel: +61 (0)2-9634 7777

CN – China, Shanghai

Tel: +86 21 2899 5000

HK – Hong Kong

Tel: +852 2428 8008

IN – India, Mumbai

Tel: +91 22 6513 7081-85

JP – Japan, Tokyo

Tel: +81 (0)3 6408 3901

KR – South Korea, Seoul

Tel: +82 2 559 0400

MY – Malaysia, Shah Alam

Tel: +60 3 7849 0800

NZ – New Zealand, Mt Wellington

Tel: +64 9 574 1744

SG – Singapore

Tel: +65 6887 6300

TH – Thailand, Bangkok

Tel: +662 186 7000

TW – Taiwan, Taipei

Tel: +886 2 2298 8987

South America

AR – Argentina, Buenos Aires

Tel: +54 3327 44 4129

BR – Brazil, Sao Jose dos Campos

Tel: +55 800 727 5374

CL – Chile, Santiago

Tel: +56 2 623 1216

MX – Mexico, Toluca

Tel: +52 72 2275 4200

European Product Information Centre

Free phone: 00 800 27 27 5374

(from AT, BE, CH, CZ, DE, DK, EE, ES, FI,
FR, IE, IL, IS, IT, LU, MT, NL, NO, PL, PT, RU,
SE, SK, UK, ZA)

