

# Measuring insert For thermocouple with flameproof enclosure (TC10-L) Model TC10-K

WIKA data sheet TE 65.11



for further approvals  
see page 2

## Applications

- Replacement measuring insert for servicing

## Special features

- Sensor ranges from -40 ... +1,200 °C (-40 ... +2,192 °F)
- Made of mineral-insulated sheathed measuring cable
- For all standard thermowell designs
- Spring-loaded design
- Explosion-protected versions



## Description

The measuring inserts for thermocouples described here are designed for installation in a thermometer model TC10-L. Operation without thermowell is appropriate only in special cases. The measuring insert is made of flexible, mineral insulated sheathed cable. The sensor is located in the tip of the measuring insert. This model is spring-loaded to ensure that the measuring insert is firmly pressed down on the thermowell bottom.

The following versions are possible:

- With mounted sleeve to suit inner diameter of the thermowell
- Without terminal block
- With transmitter

Type and number of sensors, accuracy and connection method can each be selected to suit the respective application.

## Measuring insert, model TC10-K

Only correct measuring insert length and correct measuring insert diameter ensure sufficient heat transfer from thermowell to the measuring insert.

The range of applications is completed by designs without terminal block for direct transmitter installation. Optionally, analogue or digital transmitters from the WIKA range can be installed.













## Explosion protection (option)

### Attention:

The measuring insert model TC10-K is designed for use in thermocouple model TC10-L only.

The ignition protection type Ex d is guaranteed only if the measuring insert including the supplied threaded sleeve (flameproof joint) is built into the connection head with flameproof enclosure of the thermocouple model TC10-L.

## Approvals (explosion protection, further approvals)

Logo	Description	Country
	<b>EU declaration of conformity</b> <ul style="list-style-type: none"> <li>■ EMC directive <sup>1)</sup> EN 61326 emission (group 1, class B) and immunity (industrial application)</li> <li>■ RoHS directive</li> <li>■ ATEX directive (option) Hazardous areas - Ex i Zone 1 gas [II 2G Ex ia IIC T1 ... T6 Gb]</li> </ul>	European Union
		
	<b>IECEx (option)</b> (in conjunction with ATEX) Hazardous areas - Ex i Zone 1 gas [Ex ia IIC T1 ... T6 Gb]	International
	<b>EAC (option)</b> Hazardous areas - Ex i Zone 1 gas [1 Ex ib IIC T3/T4/T5/T6]	Eurasian Economic Community
	<b>INMETCO (option)</b> Hazardous areas - Ex i Zone 1 gas [Ex ib IIC T3 ... T6 Gb]	Brazil
	<b>NEPSI (option)</b> Hazardous areas - Ex i Zone 1 gas [Ex ib IIC T3 ~ T6]	China
	<b>KCs - KOSHA (option)</b> Hazardous areas - Ex i Zone 1 gas [Ex ib IIC T4 ... T6]	South Korea
-	<b>PESO (option)</b> Hazardous areas - Ex i Zone 1 gas [Ex ib IIC T3 ... T6 Gb]	India
	<b>GOST (option)</b> Metrology, measurement technology	Russia
	<b>KazInMetr (option)</b> Metrology, measurement technology	Kazakhstan
-	<b>MTSCHS (option)</b> Permission for commissioning	Kazakhstan
	<b>BelGIM (option)</b> Metrology, measurement technology	Belarus
	<b>UkrSEPRO (option)</b> Metrology, measurement technology	Ukraine
	<b>Uzstandard (option)</b> Metrology, measurement technology	Uzbekistan

Instruments marked with "ia" may also be used in areas only requiring instruments marked with "ib" or "ic".  
 If an instrument with "ia" marking has been used in an area with requirements in accordance with "ib" or "ic", it can no longer be operated in areas with requirements in accordance with "ia" afterwards.

Approvals and certificates, see website

# Sensor

## Thermocouple per IEC 60584-1 or ASTM E230

Types K, J, E, N, T (single or dual thermocouple)

### Measuring point

- Ungrounded (standard)
- Grounded

### Sensor types

Type	Operating temperatures of the thermocouple			
	IEC 60584-1		ASTM E230	
	Class 2	Class 1	Standard	Special
K	-40 ... +1,200 °C	-40 ... +1,000 °C	0 ... 1,260 °C	
J	-40 ... +750 °C	-40 ... +750 °C	0 ... 760 °C	
E	-40 ... +900 °C	-40 ... +800 °C	0 ... 870 °C	
N	-40 ... +1,200 °C	-40 ... +1,000 °C	0 ... 1,260 °C	
T	-40 ... +350 °C		0 ... 370 °C	

The table shows the temperature ranges listed in the respective standards, in which the tolerance values (class accuracies) are valid.

The actual operating temperature of the thermometer is limited both by the maximum permissible operating temperature and the diameter of the thermocouple and the sheathed cable, as well as by the maximum permissible working temperature of the thermowell material.

Listed models are available both as single or dual thermocouples. The thermocouple will be delivered with an ungrounded measuring point, unless explicitly specified otherwise.

For detailed specifications for thermocouples, see IEC 60584-1 or ASTM E230 and Technical information IN 00.23 at [www.wika.com](http://www.wika.com).

### Tolerance value

For the tolerance value of thermocouples, a cold junction temperature of 0 °C has been taken as the basis.

### Electrical connection

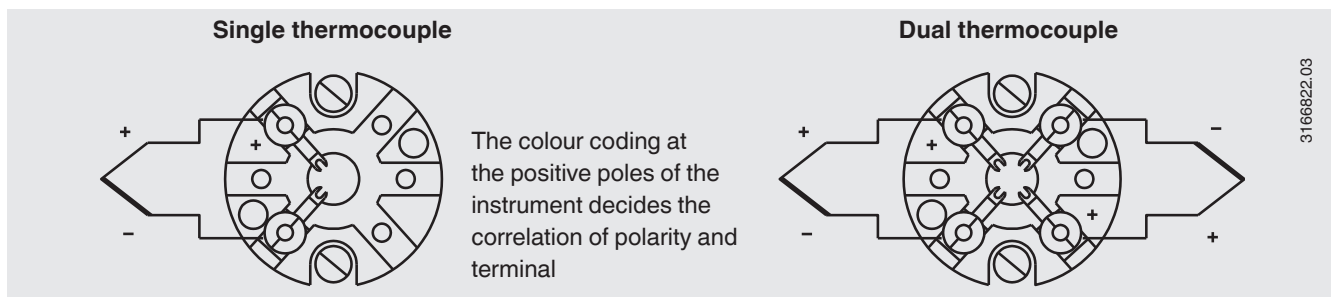

For the electrical connections of built-in temperature transmitters see the corresponding data sheets or operating instructions.

## Transmitter (option)

A transmitter can be built upon the measuring insert. In this case, the transmitter replaces the terminal block and is directly attached to the terminal plate of the measuring insert.

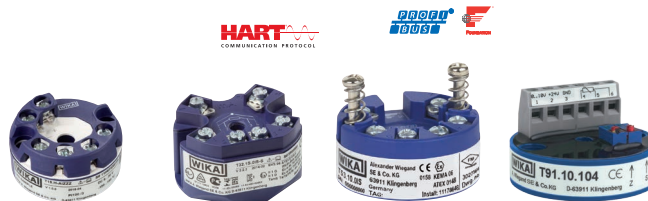

Output signal 4 ... 20 mA, HART® protocol, FOUNDATION™ Fieldbus and PROFIBUS® PA				
Transmitter (selectable versions)	Model T16	Model T32	Model T53	Model T91.10
Data sheet	TE 16.01	TE 32.04	TE 53.01	TE 91.01
<b>Output</b>				
■ 4 ... 20 mA	x	x		x
■ HART® protocol		x		
■ FOUNDATION™ Fieldbus and PROFIBUS® PA			x	
<b>Input</b>				
■ Thermocouples IEC 60584-1	K, J, E, N, T	K, J, E, N, T	K, J, E, N, T	K, J, T
<b>Explosion protection</b>	Optional	Optional	Standard	-

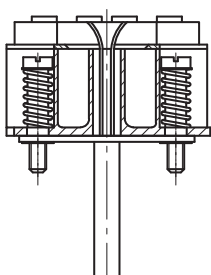

Measuring insert with mounted transmitter (here: Model T32)

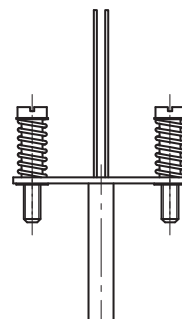

Measuring insert prepared for transmitter mounting

## Functional safety (option) with temperature transmitter model T32



In safety-critical applications, the entire measuring chain must be taken into consideration in terms of the safety parameters. The SIL classification allows the assessment of the risk reduction achieved by the safety installations.

Selected TC10-K measuring inserts in combination with a suitable temperature transmitter (e.g. model T32.1S, TÜV certified SIL version for protection systems developed in accordance with IEC 61508) are suitable as sensors for safety functions to SIL 2.

Suitable thermowells allow easy dismantling of the measuring insert for calibration. The optimally matched measuring point consists of a thermowell, a thermometer with built-in TC10-K measuring insert and a T32.1S transmitter developed in accordance with IEC 61508. Thus, the measuring point provides maximum reliability and a long service life.

# Dimensions in mm

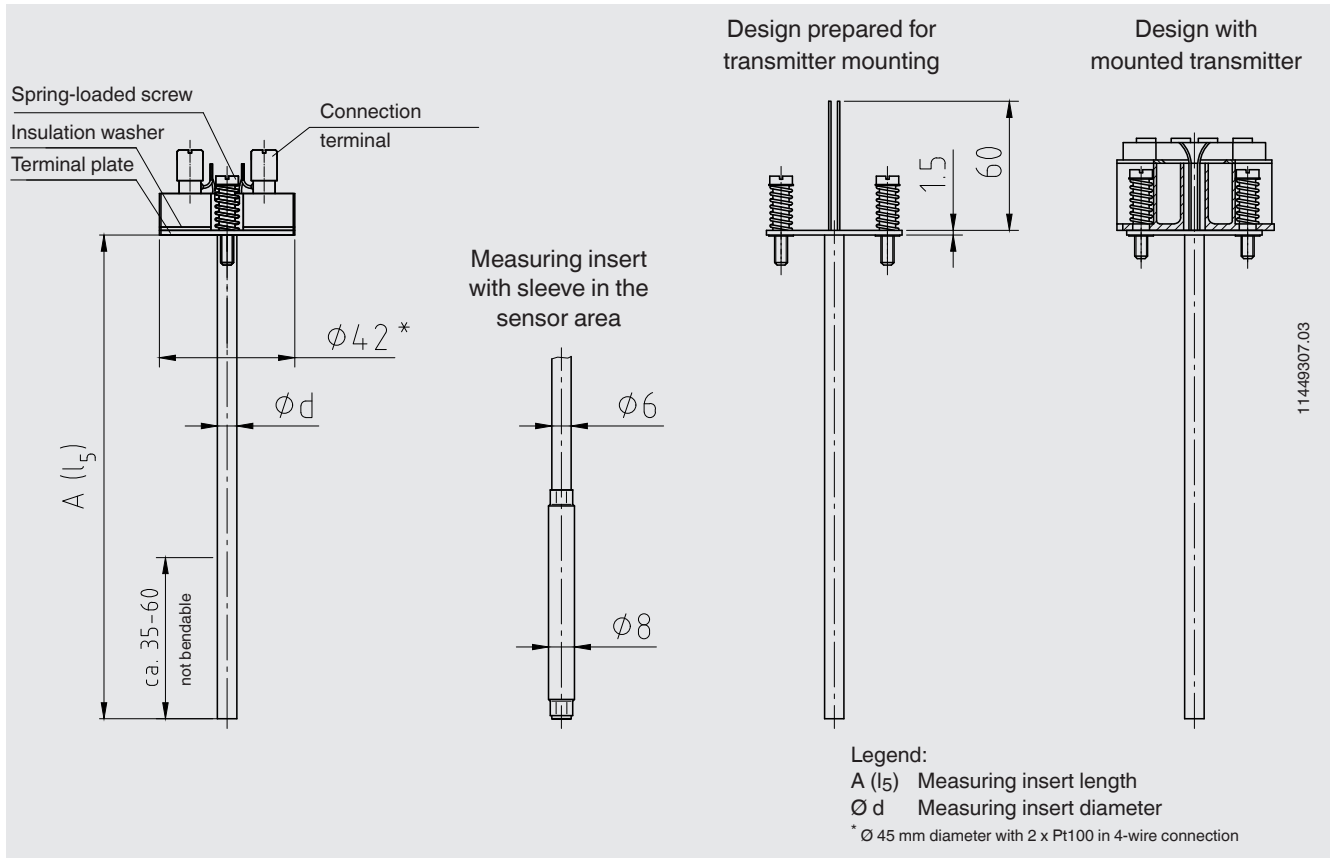

Measuring insert length l <sub>5</sub> in mm	Tolerance in mm
75 ... 825	+2 0
> 825	+3 0

**Please note:**

Max. measuring insert length = 1,100 mm  
 Only on explicit request do we deliver measuring inserts with lengths of greater than 1,100 mm in a stretched, straight form.  
 To specify this in the order, please contact your WIKA contact person.

Measuring insert diameter Ø d in mm		Index per DIN 43735	Tolerance in mm
3 <sup>1)</sup>	Standard	30	3 ±0.05
6	Standard	60	6 <sup>0</sup> -0.1
8 (6 mm with sleeve)	Standard	-	8 <sup>0</sup> -0.1
8	Standard	80	8 <sup>0</sup> -0.1
1/8 inch (3.17 mm) <sup>1)</sup> 1/4 inch (6.35 mm) 3/8 inch (9.53 mm)	Option, on request	-	-

1) Not possible with 2 x Pt100, 4-wire

## Measuring insert

The measuring insert is made of a vibration-resistant, sheathed measuring cable (MI cable). The measuring insert diameter should be approx. 1 mm smaller than the bore diameter of the thermowell. Gaps of more than 0.5 mm between thermowell and the measuring insert will have a negative effect on the heat transfer, and they will result in unfavourable response behaviour of the thermometer.

Using two screws and springs, the measuring insert can be mounted into a connection head (with flameproof enclosure, models 1/4000, 7/8000), replaceable and mounted spring-loaded.

When fitting the measuring insert into a thermowell, it is very important to determine the correct insertion length (= thermowell length for bottom thicknesses of  $\leq 5.5$  mm). In order to ensure that the measuring insert is firmly pressed down onto the bottom of the thermowell, the insert must be spring-loaded (spring travel: max 10 mm).

The standard material used for the measuring insert sheath is stainless steel. Other materials on request.

Besides twistability, this series is characterised by a high vibration resistance of the probe tip (6 g peak-to-peak<sup>1)</sup>).

1) In combination with TC10-L, vibration resistance data of the TC10-L apply.

### Attention:

Operation of the model TC10-K measuring instrument is not permitted in hazardous areas without flame path and connection head with flameproof enclosure!

## Ordering information

Model / Explosion protection / Measuring insert design / Terminal block, transmitter / Measuring element / Sensor connection method / Connection head / Temperature range / Probe tip design / Probe diameter / Sheath, tube material / Measuring insert length / Certificates / Options

© 03/2013 WIKA Alexander Wiegand SE & Co. KG, all rights reserved.  
The specifications given in this document represent the state of engineering at the time of publishing.  
We reserve the right to make modifications to the specifications and materials.

## Flame path

A flame path is built into the connection head which, in conjunction with the measuring insert, generates a flameproof joint.

If servicing is required, we recommend replacing the flame path together with the measuring insert.

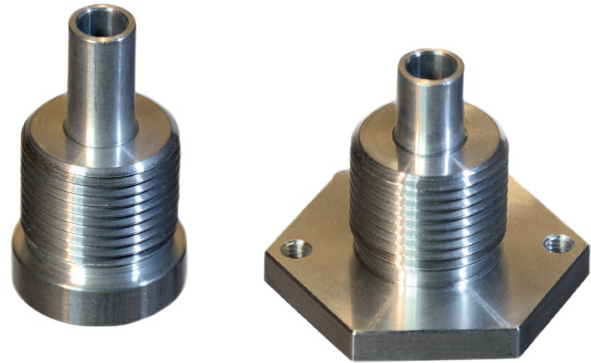

**Fig. left: Flame path for model 1/4000 connection head** (order number: 14064383)

**Fig. right: Flame path for model 7/8000 connection head and 7/8000 with DIH50** (order number: 3265731)

## Certificates (option)

Certification type	Measurement accuracy	Material certificate
2.2 test report	x	x
3.1 inspection certificate	x	x
DKD/DAkkS calibration certificate	x	-

The different certifications can be combined with each other.

