

Flow Measurement

SITRANS FS (ultrasonic)

Clamp-on ultrasonic flowmeters

SITRANS FS220 ultrasonic flowmeter

Overview



The SITRANS FS220 is a clamp-on ultrasonic flow system consisting of an FST020 transmitter and FSS200 clamp-on sensors.

The transmitter classification FST020 describes a basic clamp-on ultrasonic flowmeter for basic application requirements. Based on the same digitalized platform as the FST030 this system provides the same accuracy and similar functions on a lower cost level. This system is ideal for water measurement and any application not requiring temperature or viscosity compensation.

Benefits

- Easy installation at any time; no production stop, no need to cut pipe or stop flow
- Minimal maintenance; external sensors do not require periodic cleaning
- No moving parts to foul or wear. No contact with media
- No pressure drop or energy loss
- Wide turn-down ratio, bidirectional and high stability at zero flow conditions
- Anomaly compensation tool for correction of non-ideal straight pipe runs. Automatic compensation during backflow
- Optional WideBeam technology ensures highest performance and accuracy
- Compatible with all previously installed transit time sensors

Application

The SITRANS FS220 can be used for the following application conditions:

- Pipe sizes from 10 mm to 10 m
- Pipe materials: ideal for all metals, glass, FRP and most PVC variants; NOT for concrete pipes and special compound pipes
- Pipe wall thickness from 1 to 35 mm; specials on request up to 65 mm
- Media temperatures from -40 to 121 °C; universal high temperature sensors for up to 230 °C max.
- Underground/submerged locations, non-ideal environments, strong pipe vibrations

SITRANS FS220 flowmeters are suitable for most clean liquid applications, including the following:

- Water and wastewater industry
 - Potable water
 - Water and aqueous solutions
 - Wastewater, influent & effluent
 - Processed sewage, sludge
- Chemical feed industry
 - Sodium hypochlorite
 - Sodium hydroxide
- HVAC and power industries
 - Coolant flow
 - Fuel flow
 - Utility district heating, cooling
 - Refrigeration liquids
- Process control
 - Chemicals
 - Pharmaceuticals
 - Food products
 - Very low flow sensitivity (< 0.1 m/s)
 - High temperature liquids > 120 °C (248 °F)

Application (continued)

Sensor type selection guide



Application condition Note all that apply before making selection	Standard sensor supported in MLFB		Notes
	High precision	Universal	
Media			
General survey (clean liquids) on non-steel pipes		X	
General survey (clean liquids) on a limited range of steel pipes	X		
Moderately aerated liquid or slurry, up to 121 °C (250 °F)	X		
Permanent installation on steel pipe (clean liquids)	X		
Installation in offshore or corrosive environment	X		With optional stainless steel mounting
Liquid temperature greater than 120 °C (248 °F)	O	X	High temperature metal block sensors (up to 230 °C (446 °F))
Operation on single pipeline flowing multiple products	X	O	
Pipe material			
Steel	X		
Steel pipe with diameter/wall thickness ratio < 10	O	X	
Non-steel pipe material (copper, ductile iron, cast iron, etc.)	O	X	High precision sensors can also be used on plastic and aluminum pipes in special cases

O = not suitable X = preferred choice

Definitions

Sensor chart	Description
FSS200	Formerly 1011 clamp-on sensors of the 1010 systems
Standard	Standard system sensor, selectable as part of a configured product
Special	Sensors available for non-standard applications and pipes. Contact tech support for application use
Corrosions resistant	Stainless steel metal parts on all Size C, D and E and all high temperature sensors
Aluminum	Aluminum metal parts on all HP and Universal size A and B (Corrosion resistant on request for size B)
Spare	Not available as part of a configured product, must be ordered separately
CE	Transmitter and sensors certified for sale in the EU
Trackless mount	Sensors fixed only by straps, no other mounting (spacer bar as an option) - not recommended
Tracks	Permanent installation for universal size A/B, high precision size A/B and all sizes of high temperature. Tracks always come as dual-part for either direct or reflect mounting, and always with straps.
Frames	Three sizes, for permanent installation for universal size C/ D/ E, and for high precision size C/D. For universal and high precision size B available for pipes > 125 OD (Spare)
T1	Usable from -40 ... +120 °C (-40 ... +248 °F), but best for Ø temperature below 80 °C (< 176 °F); standard
T2	Usable from -40 ... +120 °C (-40 ... +248 °F), but best for Ø temperature above 80 °C (< 176 °F)
Submersible	Sensors can be used submerged; adding Denso for supplemental protection is recommended

Flow Measurement

SITRANS FS (ultrasonic)

Clamp-on ultrasonic flowmeters

SITRANS FS220 ultrasonic flowmeter

Application (continued)

Sensor Availability Guide

Sensor models	Availability									
	Standard	Spare only	Corrosion resistant	Trackless	Tracks	Frames	T1 best use below 80 °C (176 °F)	T2 best use 80 ... 120 °C (176 ... 248 °F)	Submersible	Catalog
Universal Sensor -40 ... 120 °C housing CE IP68										
A1 Universal for pipe OD – 5.8 ... 50.8 mm (0.23" ... 2")		X			X				X	
A2 Universal for pipe OD – 12.7 ... 50.8 mm (0.5" ... 2")	X				X				X	X
B1 Universal for pipe OD – 12.7 ... 76 mm (0.5" ... 3")		X			X	X			X	
B2 Universal for pipe OD – 12.7 ... 76 mm (0.5" ... 3")		X			X	X			X	
B3 Universal for pipe OD – 19 ... 127 mm (0.75" ... 5")	X				X	X			X	X
C1 Universal for pipe OD – 51 ... 254 mm (2" ... 10")		X	X	X		X			X	
C2 Universal for pipe OD – 51 ... 254 mm (2" ... 10")		X	X	X		X			X	
C3 Universal for pipe OD – 51 ... 305 mm (2" ... 12")	X		X	X		X			X	X
D1 Universal for pipe OD – 102 ... 508 mm (4" ... 20")		X	X	X		X			X	
D2 Universal for pipe OD – 152 ... 610 mm (6" ... 24")		X	X	X		X			X	
D3 Universal for pipe OD – 203 ... 610 mm (8" ... 24")	X		X	X		X			X	X
*E1 Universal for pipe OD – 254 ... 3048 mm (10" ... 120")		X	X	X		X			X	
*E2 Universal for pipe OD – 254 ... 6096 mm (10" ... 240")	X		X	X		X			X	X
*E3 Universal for pipe OD – 304 ... 10007 mm (12" ... 394")		X	X	X		X			X	
High Precision Sensor -40 ... 120 °C (-40 ... +248 °F) T1 (T2) CE IP68										
A1H (High Precision) for pipe WT - 0.64 ... 1.0 mm (0.025" ... 0.04")		X			X		X		X	X
A2H (High Precision) for pipe WT - 1.0 ... 1.5 mm (0.04" ... 0.06")	X				X		X		X	X
A3H (High Precision) for pipe WT - 1.5 ... 2.0 mm (0.06" ... 0.08")	X				X		X		X	X
B1H (High Precision) for pipe WT - 2.0 ... 3.0 mm (0.08" ... 0.12")	X				X	X	X	X	X	X
B2H (High Precision) for pipe WT - 3.0 ... 4.1 mm (0.12" ... 0.16")	X				X	X	X	X	X	X
B3H (High Precision) for pipe WT - 2.7 ... 3.3 mm (0.106" ... 0.128")		X			X	X	X	X	X	X
C1H (High Precision) for pipe WT - 4.1 ... 5.8 mm (0.16" ... 0.23")	X		X	X		X	X	X	X	X
C2H (High Precision) for pipe WT - 5.8 ... 8.1 mm (0.23" ... 0.32")	X		X	X		X	X	X	X	X
* D1H (High Precision) for pipe WT - 8.1 ... 11.2 mm (0.32" ... 0.44")	X		X	X		X	X	X	X	X
* D2H (High Precision) for pipe WT - 11.2 ... 15.7 mm (0.44" ... 0.62")	X		X	X		X	X	X	X	X
* D3H (High Precision) for pipe WT - 7.4 ... 9.0 mm (0.293" ... 0.354")		X	X	X		X	X	X	X	X
* D4H (High Precision) for pipe WT - 15.7 ... 31.8 mm (0.62" ... 1.25")	X		X	X		X	X	X	X	X
High Temperature Universal Sensor -40 ... +230 °C (-40 ... +446 °F)										
High Temperature size 1 ... 230 °C (Ø 12.7 ... 100 mm)		X	X		X				X ¹⁾	
High Temperature size 2 ... 230 °C (Ø 30 ... 200 mm)	X		X		X				X	X
High Temperature size 3 ... 230 °C (Ø 150 ... 610 mm)	X		X		X				X	X
High Temperature size 4 ... 230 °C (Ø 400 ... 1200 mm)	X		X		X				X	X
High Temperature size 2A ... 230 °C (Ø 30 ... 200 mm)		X	X		X				X ¹⁾	
High Temperature size 3A ... 230 °C (Ø 150 ... 610 mm)		X	X		X				X ¹⁾	
High Temperature size 4A ... 230 °C (Ø 400 ... 1200 mm)		X	X		X				X ¹⁾	

Application (continued)

Sensor mounting availability guide

Mounting	Sensor (Dedicated)		
	Universal	High precision	High temperature universal
Trackless (straps only)	X	X	
Tracks universal dedicated	X		
Tracks HP dedicated		X	
Frames universal dedicated	X		
Frames HP dedicated		X	
Tracks high temperature universal			X
High precision mounting single enclosure for one pair sensors		X	
High precision mounting dual enclosure for one pair sensors		X	
SpacerBar	X	X	
Straps	X	X	X
Denso	X	X	

Function

Operating principle

The SITRANS F S system is a transit-time ultrasonic meter that provides exceptional performance using a non-intrusive clamp-on approach. Ultrasonic sensors transmit and receive acoustic signals directly through the existing pipe wall, where the fluid refraction angle is governed by Snell's law of refraction.

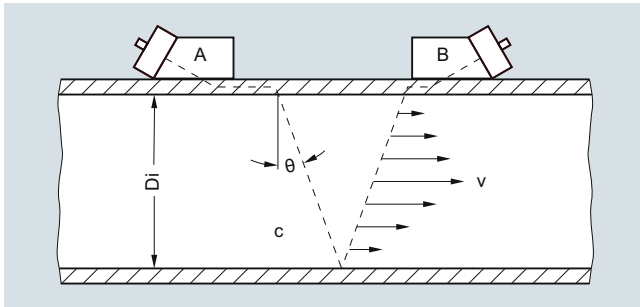

Clamp-on sensor mounted in a reflect configuration

The beam refraction angle is calculated as follows:

$$\sin \theta = c / V_{\phi}$$

c = Velocity of sound in fluid

V_{ϕ} = Phase velocity (a constant in the pipe wall)

The flowmeter automatically compensates for any change in fluid sound velocity (or beam angle) in response to variations in the average transit time between sensors A and B. By subtracting the computed fixed times (within the sensor and pipe wall) from the measured average transit time, the meter can then infer the required transit time in the fluid (T_{Fluid}).

The sound waves traveling in the same direction as the flow ($T_{A,B}$) arrive earlier than sound waves traveling against the direction of flow ($T_{B,A}$). This time difference (Δt) is used to compute the line integrated flow velocity (v) as shown in the equation below:

$$v = V_{\phi} / 2 \cdot \Delta t / T_{\text{Fluid}}$$

Once the raw flow velocity is determined, the fluid Reynolds Number (Re) must be determined to properly correct for fully developed flow profile. This requires the entry of the fluid's kinematic viscosity (visc) as shown in the equations below, where Q represents the final flow profile compensated volumetric flow rate.

$$Re = Di \cdot v / \text{visc} \quad Q = K(Re) \cdot (\pi / 4 \cdot Di^2) \cdot v$$

v = Flow velocity

$\text{visc} = \mu / \rho$ = (dynamic viscosity / density)

$K(Re)$ = Reynolds flow profile compensation

In wetted type ultrasonic flowmeters the meter constants are configured prior to leaving the factory. As this is not possible with clamp-on meters, the settings must be made by the customer at the time of installation. These settings include pipe diameter, wall thickness, liquid viscosity, etc.

SITRANS clamp-on flowmeters that include temperature sensing can be configured to dynamically infer changes in fluid viscosity for the purpose of computing the most accurate flow profile compensation (K_{Re}).

Ultrasonic sensor types

Two basic types of clamp-on sensors can be selected for use with the SITRANS F S flowmeter. The lower cost "universal" sensor is the most common type in the industry and is suitable for most single liquid applications where the sound velocity does not vary much. This sensor type can be used on any sonically conductive pipe material (including steel) making it well suited for temporary survey applications. Universal sensors are selected based on the pipe diameter range alone, so wall thickness is less important to the selection process.

The second sensor type is the patented "WideBeam" sensor (called high precision), which utilizes the pipe wall as a kind of waveguide to optimize the signal to noise ratio and provide a wider area of vibration. This makes this kind of sensor less sensitive to any change in the fluid medium.

The WideBeam sensor is designed for steel pipes, but can also be used with aluminum and titanium. It is the preferred sensor for HPI applications. Note that unlike the universal type, this sensor selection is dependent only on the pipe's wall thickness.

Flow Measurement

SITRANS FS (ultrasonic)

Clamp-on ultrasonic flowmeters

SITRANS FS220 ultrasonic flowmeter

Function (continued)

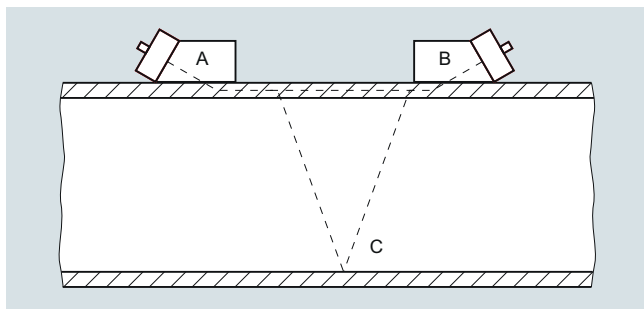

General installation guidelines for SITRANS FSS200 clamp-on sensor

- Minimum measuring range: 0 to ± 0.3 m/s velocity (see meter accuracy graph on next page for more detail)
- Maximum measuring range: 0 to ± 12 m/s (± 30 m/s for high precision sensors). Final flow range determination requires application review

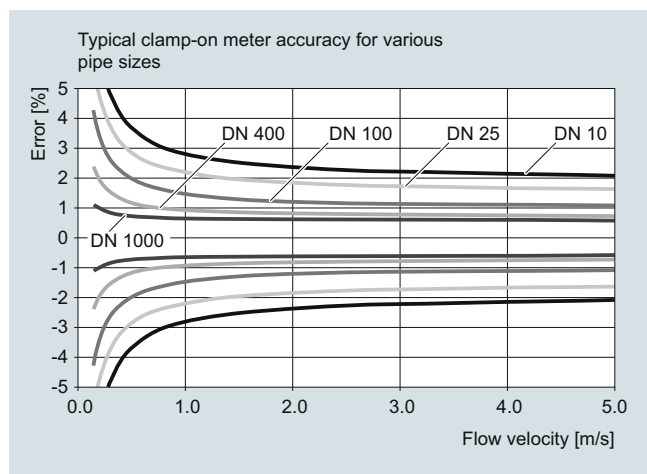

- Pipe must be completely full within the sensor installation volume for accurate flow measurement
- Typical MINIMUM straight pipe requirements are: 10 Diameters upstream/5 Diameters downstream. Additional straight run is required for double out-of-plane elbows and partially open valves.
- Sensors should be installed at least 20° off vertical for horizontal pipes. This reduces the chance of beam interference from gas buildup at the top of the pipe
- Operation inside the Reynolds transition region, between $1000 < Re < 5000$ should be avoided for best accuracy
- Submersible and direct burial installations can be accommodated. Consult sales representative for details
- Ultrasonic coupling compound is provided with all sensor orders. Insure that a permanent coupling compound is used for long term installations
- Refer to the "Sensor type selection guide" to insure proper application of the equipment

Technical specifications

Rangeability	
Flow range	± 12 m/s (± 40 ft/s), depending on pipe size higher or lower
Flow direction	bi-directional
Flow sensitivity	0.001 m/s (0.003 ft/s) flow rate independent
Digital inputs	
Totalizer Hold	Optically isolated diode Activated On: Input voltage: 2 ... 10 V DC
Totalizer Reset	Optically isolated diode Activated On: Input voltage: 2 ... 10 V DC
Output Channel 1	
Current	4 ... 20 mA (isolated) Externally powered 10 ... 30 V DC
Relay	30 V DC, 3 V AC max. Pulse: 41.6 ms ... 5 s pulse duration Frequency: 0 ... 12.5 kHz (50 % duty cycle)
Pulse rate	Optically isolated transistor 10 mA, 30 V DC max.
Accuracy	
Repeatability	For velocities above 0.3 m/s (1 ft/s), ± 1.0 % of flow
Zero Drift	± 0.25 % (according to ISO 11631)
Data refresh rate	0.1 % of rate; $< \pm 0.001$ m/s (± 0.003 ft/s)
Transmitter conditions	
Operating temperature	-10 ... +50 °C (14 ... 122 °F)
Storage temperature	-20 ... +60 °C (-4 ... +140 °F)
Degree of protection	IP65, NEMA 4X
Design	
Weight	1.4 kg (3.0 lb)
Dimensions (W x H x D)	176 x 240 x 87 mm (6.9 x 9.5 x 3.4 inch)
Enclosure material	Polycarbonate
Power supply	
	100 ... 240 V AC @ 20 VA or 11.5 ... 28.5 V DC @ 10 W
Certificates and approvals	
Unclassified locations	
• General Safety	UL, cUL, CE

Selection and ordering data	Article No.	Article No.
<i>Spare parts (FSS200 sensors)</i>		
SITRANS F US clamp-on	7ME3950-5	7ME3960-
Temperature range for all sensors is unless otherwise noted		
-40 °C ... +120 °C (-40 °F ... +248 °F)		
Ideal operating temperatures as follows:		
T1: -40 ... +80 °C (-40 ... +176 °F)	0	0 M A 0 0
T2: +80 ... 121 °C (+176 ... 250 °F)	2	0 M B 0 0
Spare sensor code		
(Stainless steel construction)		
<u>Liquid flow sensors for use with mounting frames or tracks (including portable)</u>		
FSS200 A2 universal	L B 0 1	CQO:1012FN-PB
FSS200 B3 universal	L C 0 1	0 M C 0 0
FSS200 C3 universal	L D 0 0	0 M C 0 1
FSS200 D3 universal	L E 0 0	0 M C 0 2
FSS200 E2 universal	L F 0 0	CQO:1012FNH-PB
FSS200 A1H (high precision)	L G 0 1	0 M D 0 0
FSS200 A2H (high precision)	L H 0 1	0 M D 0 1
FSS200 A3H (high precision)	L J 0 1	0 S M 0 0
FSS200 B1H (high precision)	G K 1	0 S M 1 0
FSS200 B2H (high precision)	G L 1	0 S M 2 0
FSS200 B3H (high precision)	G T 1	0 S M 3 0
FSS200 C1H (high precision)	G M 0	0 S M 4 0
FSS200 C2H (high precision)	G N 0	0 S M 5 0
FSS200 D1H (high precision)	G P 0	0 S M 6 0
FSS200 D2H (high precision)	G Q 0	
FSS200 D3H (high precision)	G U 0	
FSS200 D4H (high precision)	G R 0	
<u>High temperature universal liquid sensors up to 230 °C (446 °F)</u>		
FSS200 High temp. sensor size 1 for 12.7 to 100 mm diam.	L A 1 3	
FSS200 High temp. sensor size 2 for 30 to 200 mm diam.	L A 2 3	
FSS200 High temp. sensor size 3 for 150 to 600 mm diam.	L A 4 3	
FSS200 High temp. sensor size 4 for 400 to 1200 mm diam.	L A 7 3	
<i>Spare parts (Miscellaneous)</i>		
SITRANS F US clamp-on		
Dedicated sensor mounting hardware		
Sensor mounting tracks (dual part aluminium with mounting straps) for pipes < 125 mm (5 inch)		
• Tracks for Universal sensor pair size A or B		
• Tracks for High precision sensor pair size A or B		
Sensor mounting frames pair with mounting straps		
• Frames for universal sensor size B (for pipes >125 mm (5 inch))		
• Frames for universal sensor size C		
• Frames for universal sensor size D		
• Frames for universal sensor size E		
• Frames for High precision sensor size B (for pipes >125 mm (5 inch))		
• Frames for High precision sensor size C		
• Frames for High precision sensor size D		
Mounting straps for mounting frames (slotted stainless steel)		
• Straps for pipes from DN 50 to DN 150		
• Straps fFor pipes from DN 50 to DN 300		
• Straps fFor pipes from DN 300 to DN 600		
• Straps for pipes from DN 600 to DN 1200		
• Straps for pipes from DN 1200 to DN 1500		
• Straps fFor pipes from DN 1500 to DN 2100		
• Straps for pipes from DN 2100 to DN 3000		
Spacer bars (for indexing sensors on pipe)		
• Spacer bar for pipes to 200 mm/8 inch (liquid), 600 mm/24 inch (gas)		0 M S 1 0
• Spacer bar for pipes to 500 mm/20 inch (liquid), DN 1200/48 inch (gas)		0 M S 2 0
• Spacer bar for pipes to 800 mm/32 inch (liquid)		0 M S 3 0
• Spacer bar-extension for pipes to 1200 mm/48 inch (liquid) Only use in conjunction with 7ME3960-OMS30		0 M S 4 0
High precision mounting enclosures. Spacer bar is included; straps should be ordered separately		
• Stainless steel mounts for high precision size "C" sensor pair, single enclosure (each)		0 W S 5 0
• Stainless steel mounts for high precision size "D/E" sensor pair, single enclosure (each)		0 W S 6 0
• Stainless steel mounts for high precision size "C" sensors, dual enclosure (pair)		0 W D 5 0
• Stainless steel mounts for high precision size "D/E" sensors, dual enclosure (pair)		0 W D 6 0
Stainless steel straps for weld seal enclosure mounting (2 x required for dual enclosures)		
Mounting strap for pipe diameter to 300 mm (13 inch)		0 S M 0 1
Mounting strap for pipe diameter to 600 mm (24 inch)		0 S M 1 1
Mounting strap for pipe diameter to 1200 mm (48 inch)		0 S M 2 1
Mounting strap for pipe diameter to 1500 mm (60 inch)		0 S M 3 1
Mounting strap for pipe diameter to 2130 mm (84 inch)		0 S M 4 1
Mounting strap for pipe diameter to 3050 mm (120 inch)		0 S M 5 1

Flow Measurement

SITRANS FS (ultrasonic)

Clamp-on ultrasonic flowmeters

SITRANS FS220 ultrasonic flowmeter

Selection and ordering data

Article No.

Spare parts (Miscellaneous)

SITRANS F US clamp-on

7ME3960- 

Stainless mounting tracks for high temp 991 sensors, with straps, dual part for direct and reflect out, inc. straps

Size 1 high temp sensor pair

CQO:992MTNHMSH-1 

Size 2 high temp sensor pair

CQO:992MTNHMSH-2 

Size 3 high temp sensor pair

CQO:992MTNHMSH-3 

Size 4 high temp sensor pair

CQO:992MTNHMSH-4 

Sensor cables FSS220 (IP65 NEMA 4X) wall mount

Sensor cable pair, terminated, 5 m

A5E39669934031 

Sensor cable pair, terminated, 10 m

A5E39669934032 

Sensor cable pair, terminated, 20 m

A5E39669934033 

Sensor cable pair, terminated, 30 m

A5E39669934042 

Sensor cable pair, terminated, 60 m

A5E39669934043 

Sensor cable pair, terminated, 100 m

A5E39669934044 

Dedicated cable termination kits

For externally supplied sensor cables, standard and plenum

0 C T 0 1 

Cable gland kit (normally supplied with transmitter)

for IP65 NEMA 4X enclosures

A5E41693895 

Ultrasonic couplant

Temporary water based for portable systems:
350 ml (12 oz): -34 ... +38 °C (-30 ... +100 °F)0 U C 1 0 Permanent synthetic polymer based:
90 ml (3 oz): -40 ... +190 °C (-40 ... +375 °F)0 U C 2 0 Permanent high temp fluoroether:
-40 ... +230 °C (-40 ... +450 °F)0 U C 3 0 Permanent vulcanizing silicone rubber couplant:
90 ml (3 oz): -40 ... +120 °C (-40 ... +250 °F)CQO:CC112 Permanent high temp silicone grease:
12 ml (0.4 oz): -40 ... +230 °C (-40 ... +450 °F)CQO:CC117 Permanent high temp silicone grease:
150 ml (5 oz): -40 ... +230 °C (-40 ... +450 °F)CQO:CC117A 

Couplant for submersible sensor applications

CQO:CC120 Dry coupling pads (qty of 10):
-34 to +200 °C (-30 to +392 °F)0 U C 4 0 

Universal Sensor Test Blocks

Test block for size A and B universal sensors

0 T B 1 0 

Test block for size C and D universal sensors

0 T B 2 0 

Accessories

Description

Article No.

FSS200 Universal Sensors

7ME3950-...

Selected for general purpose measurement.

Since they are selected based on diameter only, a wide range of pipe sizes and materials can be covered with a minimum number of sensors. These can also be selected for cost savings on applications where standard accuracy is sufficient.

FSS200 High Precision Sensors

7ME3950...

Selected for increased performance on steel pipes. They provide the highest accuracy achievable by the meters and therefore should be selected whenever higher accuracy / repeatability is required primarily based on pipe wall thickness.



FSS200 High Temperature Sensors

7ME3950-...

Selected whenever pipe temperature will exceed 250 °F (120 °C) up to a maximum of 450 °F (232 °C). They are universal type and can therefore be used on any pipe material and are selected by pipe diameter. Constructed in stainless steel. Connection junction box included.



Mounting tracks

7ME3960-...

Typically used on smaller pipes for easier and more stable mounting of dedicated universal style sensor size A or B; also available for dedicated high precision sensor size A or B.



Mounting Frames

7ME3960-...

These items are useful in simplifying sensor installation. They are strapped to the pipe first and then the sensors are installed, making the installation less cumbersome and more precise. They also enable easy repeated mounting of the sensors assuring alignment to the original sensor positioning. They may be left in place at each measurement location where periodic flow surveys are conducted to simplify subsequent installations and ensure repeatable results.











Magnetic mounting frames

7ME3960-0MD02

Magnetic mounting frames are designed to simplify clamp-on sensor installation on pipelines 8 inches (DN 200) and larger by eliminating the need for straps to secure them. They feature powerful magnets to ensure quick and accurate setup. Compatible with all C, D and E universal and high-precision sensors belonging to the SITRANS FSS200 clamp-on family. Magnetic mounting frames are constructed in aluminum for a high level of durability. Ideal use on temporary installations.

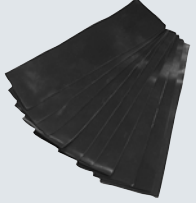

Selection and ordering data (continued)

Description	Article No.		Description	Article No.	
Test Block Used for checking operation of a meter and sensors prior to a field installation, or as a troubleshooting tool. Selected by sensor size, each block accommodates 2 sensor sizes. Available only for universal sensors.	7ME3960...		FST020 Transmitter module Main transmitter module for FST020 including SD-card and firmware load	A5E41693884	
Straps Used to fasten sensors or mounting frames to pipe for dedicated meter installations. Stainless steel construction for corrosion resistance.	7ME3960-...		FST020 Transmitter module cover AC Cover for FST020 Main transmitter module for AC powered units; includes label and screws	A5E41693888	
Cable Gland Cable gland kit for use with SITRANS FST020 transmitters housed in IP65 NEMA 4X wall mount enclosures. Kit contains two single port glands for power and one dual port gland for sensor cables.	A5E41693895		FST020 Transmitter module cover DC Cover for FST020 Main transmitter module for DC powered units; includes label and screws	A5E41693889	
Ultrasonic Couplant Fills any voids between sensor emitting surface and pipe wall to allow maximum energy transfer between sensor and pipe. Several different types of couplants are employed as determined by the application conditions and type of installation (Temporary or permanent).	7ME3960-...		FST020 Enclosure cover Enclosure lid for FST020; includes display module, connection label and screws	A5E38846901	
Dry Couplant The dry coupling pad is intended for use in any liquid, clamp-on transit time or Doppler applications that require a more durable coupling material. Installation is easy by simply placing one strip of material between sensor and pipe. Not intended for clamp-on gas where damping material is used. The temperature range is -34 to +200 °C (-30 to +392 °F).	7ME3960-...		FST020 Power Supply AC Power supply module for FST020, AC power	7ML1830-1MD	
Termination Kit (Flow Sensors) Termination kit for one pair of sensor cables. These can be provided in cases where users will be purchasing bulk cable directly and cutting to length at site, or when existing cable length is to be altered. Selected by cable type.	7ME3960-...		FST020 Power Supply DC Power supply module for FST020, DC power	7ML1830-1ME	
			SensorFlash SD-card 4 GB micro SD card -40 °C ... +85 °C for FST020 or FST030 for data storage, firmware and back-up	A5E38288507	
			Hardware kit Various nuts, screws, and grounding strap for FST020 transmitter	A5E41944763	
			Sensor cable pair, 5 m Sensor cable for connection between FSS200 sensors and FST020 transmitter, 5 meters in length	A5E39669934031	
			Sensor cable pair, 10 m Sensor cable for connection between FSS200 sensors and FST020 transmitter, 10 meters in length	A5E39669934032	
			Sensor cable pair, 20 m Sensor cable for connection between FSS200 sensors and FST020 transmitter, 20 meters in length	A5E39669934033	
			Enclosure mounting kit Mounting kit to fix enclosure on a 2" stanchion pipe	QCB:1012NMB1	

Flow Measurement

SITRANS FS (ultrasonic)

Clamp-on ultrasonic flowmeters

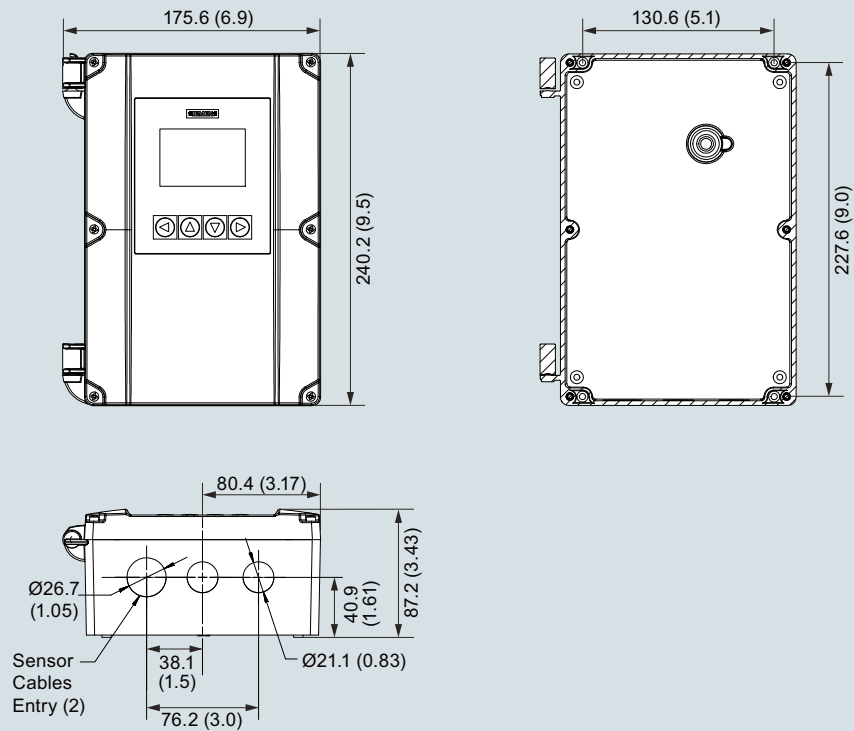
SITRANS FS220 ultrasonic flowmeter**Dimensional drawings**

SITRANS FST020 IP65 (NEMA 4X), wall mount enclosure, dimensions in mm (inch)

SITRANS FST020 ultrasonic flow transmitter, wall mount housing

Overview



The SITRANS FST020 is the basic device for simple and cost-effective clamp-on applications. As a single-path device, it is suitable for flow measurement on liquids that do not require temperature or viscosity consideration and where highest accuracies are not required.

Historically, the FST020 comes from the clamp-on family of analog FUS1010 transmitters. Since the revision in 2017, the updated transmitter is now part of a digital platform based on the latest developments within Digital Signal Processing (DSP) technology - engineered for high measuring performance, fast response to step changes in flow, high immunity against process noise and simplicity in installation, commissioning and maintenance.

The FST020 transmitter delivers standard parameter measurements i.e. volume flow, flow speed or sound velocity by analog outputs and Modbus communication.

Process values

- Volume flow
- Flow velocity
- Sound velocity
- Totalizer 1

Benefits

Flow calculation and measurement

- Dedicated volume flow calculation with DSP technology
- 100 Hz update rate for all primary process values
- Maximum data age from sensor to output is 20 ms
- Independent low flow cut-off settings for volume flow and velocity
- Zero-point adjustment on command from discrete input or host system

Operation and display

- User-configurable operation display
 - Fully graphical display 240 x 160 pixel display with up to 6 programmable views
 - Self-explaining alarm handling/log in clear text
 - Help text for all parameters appears automatically in the configuration menu

- SensorFlash technology stores production specific system documentation and provides removable memory of all flow-meter setups and functions
 - Calibration certificates (with ordered calibration)
 - Non-volatile memory backup of operational data
 - Transfer of user configuration to other flowmeters
 - 4GB SD card for storage and data logging
 - Audit trail of all parameter changes
 - Alarm logging

Alarms and safety

- Advanced diagnosis and service menu enhances troubleshooting and meter validation
- Configurable upper and lower alarm and warning limits for all process values

Outputs and control

- Monitoring comprised of 1 individually configurable totalizer
- Single parameter outputs that can be assigned individually to any of the following parameters:
 - Volume flow
 - Flow velocity
 - Sound velocity
 - Flow direction

Channel 1 is 4 to 20 mA analog output. The current signal can be configured for passive volume flow.

Relay output(s) can be user configured to Alarm status or warning.

Modbus RTU RS 485 comes as standard.

Signal input

The signal input can be user-configured for:

- Totalizer reset functions
- Forcing outputs or freezing process values
- Initiating automatic zero point adjustment

Approvals and certificates

The SITRANS FST020 transmitter was designed to comply with or exceed the requirements of international standards and regulations.

Design

- Field clamp-on (non-intrusive)
- Single path, for only one pair of sensors on one pipe
- IP65 (NEMA 4X) wall mount housing, constructed of polycarbonate
- Available AC or DC power, 100 to 240 V AC, 11.5 to 28.5 V DC

Function

- 240 x 160 pixel graphical display with 4 key navigation and backlight
- 6 user programmable views for individual process and diagnostic information
- Modbus RTU communication
- 100 Hz update rate for all primary process value
- Independent low flow cut-off settings for volume and flow velocity
- Fully compatible with Siemens PDM version 8.2 service pack 1 or higher
- Bidirectional flow operation
- Menus available in English and German

Flow Measurement

SITRANS FS (ultrasonic)

Clamp-on ultrasonic flowmeters

SITRANS FST020 ultrasonic flow transmitter, wall mount housing

Technical specifications

Input	
Flow range	± 12 m/s (± 40 ft/s), depending on pipe size higher or lower
Flow direction	bi-directional
Flow sensitivity	0.0003 m/s (0.001 ft/s) flow rate independent
Digital inputs	
Totalizer Hold	Optically isolated diode Activated ON: Input voltage: 2 ... 10 V DC
Totalizer Reset	Optically isolated diode Activated ON: Input voltage: 2 ... 10 V DC
Output Channel 1	
Current	4 ... 20 mA (isolated) Externally powered 10 ... 30 V DC
Relay	30 V DC, 3 VA AC max.
Pulse rate	Optically isolated transistor 10 mA, 30 V DC max Pulse: 41.6 ms ... 5 s pulse duration Frequency: 0 ... 12.5 kHz (50 % duty cycle)
Accuracy	
Accuracy	For velocities above 0.3 m/s (1 ft/s), ±1.0 % of flow
Repeatability	± 0.25 % (according to ISO 11631)
Zero Drift	0.1 % of rate; < ±0.001 m/s (±0.003 ft/s)
Data refresh rate	100 Hz
Rated operation conditions	
Operating temperature	-10 ... +50 °C (14 ... +122 °F)
Storage temperature	-20 ... +60 °C (-4 ... +140 °F)
Degree of protection	IP65/NEMA 4X
Design	
Weight	1.4 kg (3.0 lbs)
Dimensions (W x H x D)	176 x 240 x 87 mm (6.9 x 9.5 x 3.4 inch)
Enclosure material	Polycarbonate
Power supply	
	100 ... 240 V AC @ 20 VA or 11.5 ... 28.5 V DC @ 10 W
Certificates and approvals	
Unclassified locations	
• General safety	UL, cUL, CE

SITRANS FST020 ultrasonic flow transmitter, wall mount housing

Selection and ordering data	Article No.
Transmitter SITRANS FST020 (Basic), IP65 (NEMA 4X)	7ME3570- Ord. Code
Click on the Article No. for the online configuration in the PIA Life Cycle Portal.	
Number of ultrasonic paths	1
Single path	
Flowmeter functions and I/O configurations	J
With display, keypad, 1x 4 ... 20 mA, 1x relay, 1x pulse/frequency, 2x digital input, Modbus RTU	
Meter power options	A B
100 ... 240 V AC	
11.5 ... 28.5 V DC	
Sensor FSS200¹⁾	
When ordering a flow system, sensors always come automatically with suitable mounting equipment. Smaller sensor sizes A & B come with mounting tracks, while sensor sizes C, D & E are supplied with frames and spacer bars. Straps provided are for the indicated maximum OD listed below. Strap kits are available to accommodate larger pipes (refer to spare part list). Refer to "Sensor Selection Charts" to find the most suitable sensors for specific pipe sizes and wall thicknesses.	
No sensor	A
For the following Universal sensors, temperature range is -40 ... +121 °C (-40 ... +250 °F), FSS200 Universal: select according to outer pipe diameter	
FSS200 Universal A2 12.7 ... 50 mm (0.5 ... 2") Track mount and straps provided up to 75 mm (3")	B
FSS200 Universal B3 19 ... 127 mm (0.75 ... 5") Track mount and straps provided up to 125 mm (5")	C
FSS200 Universal C3 51 ... 305 mm (2 ... 12") Mounting frame, straps and spacer bar provided up to 330 mm (13")	D
FSS200 Universal D3 203 ... 610 mm (8 ... 24") Mounting frame and straps and spacer bar provided up to 600 mm (24")	E
FSS200 Universal E2 304 ... 9144 mm (12 ... 360") Mounting frame and straps and spacer bar provided up to 1200 mm (48")	F
For the following High Precision sensors T1, temperature range is -40 ... +120 °C (-40 ... +248 °F), FSS200 High Precision: select according to pipe wall thickness	
FSS200 HP A1H 0.6 ... 1.0 mm (0.025 ... 0.4") Track mount and straps provided up to 75 mm (3")	G
FSS200 HP A2H 1.0 ... 1.5 mm (0.04 ... 0.06") Track mount and straps provided up to 75 mm (3")	H
FSS200 HP A3H 1.5 ... 2.0 mm (0.06 ... 0.08") Track mount and straps provided up to 75 mm (3")	J
FSS200 HP B1H 2.0 ... 3.0 mm (0.08 ... 0.12") Track mount and straps provided up to 125 mm (5")	K
FSS200 HP B2H 3.0 ... 4.1 mm (0.12 ... 0.16") Track mount and straps provided up to 125 mm (5")	L
FSS200 HP C1H 4.1 ... 5.8 mm (0.16 ... 0.23") Mounting frame, straps and spacer bar up to 600 min (24")	M
FSS200 HP C2H 5.8 ... 8.1 mm (0.23 ... 0.32") Mounting frame, straps and spacer bar up to 600 min (24")	N
FSS200 HP D1H 8.1 ... 11.2 mm (0.32 ... 0.44") Mounting frame and straps provided up to 1200 mm (48") ¹⁾	P
FSS200 HP D2H 11.2 ... 15.7 mm (0.44 ... 0.62") Mounting frame and straps provided up to 1200 mm (48") ¹⁾	Q
FSS200 HP D4H 15.7 ... 31.8 mm (0.62 ... 1.25") Mounting frame and straps provided up to 1200 mm (48") ¹⁾	R
For the following High Temperature sensors, temperature range is -40 ... +230 °C (-40 ... +446 °F), FSS200 High Temperature: select according to outer diameter	
FSS200 HT Size 2 30 ... 200 mm (1 ... 8") Mounting track and straps provided up to 250 mm (10")	Z P 1 A
FSS200 HT Size 3 150 ... 610 mm (6 ... 24") Mounting track and straps provided up to 650 mm (26")	Z P 2 A
FSS200 HT Size 4 400 ... 1200 mm (16 ... 48") Mounting track and straps provided up to 1250 mm (50")	Z P 3 A
Sensor cable (pair - terminated)	
No sensor cable	A
Sensor cable, HDPE jacket, submersible, length	
• 5 m (16.4 ft)	P
• 10 m (32.8 ft)	Q
• 20 m (65.6 ft)	R
• 30 m (98.4 ft)	S
• 60 m (196.8 ft)	T
• 100 m (328 ft)	U
Approvals	
UL, ULc, CE	1



¹⁾ Supplied spacer bar supports pipes up to 1050 mm (42"). For pipes larger than 1050 mm (42") purchase also, spare part 7ME3960-0MS40 (1012BN-4).
²⁾ Made of stainless steel construction.

Flow Measurement

SITRANS FS (ultrasonic)

Clamp-on ultrasonic flowmeters

SITRANS FST020 ultrasonic flow transmitter, wall mount housing

Selection and ordering data

Order code

Further designs

Please add "-Z" to Article No. and specify Order code(s).

Cable termination kit for customer supplied sensor cable pair

Sensor cable termination for standard and plenum cable

T01

Mass storage

Enable mass storage function or SD-card (not available for USA)

S30

Tag and name plates

Tag plate, transmitter and sensor

Y19

Dimensional drawings

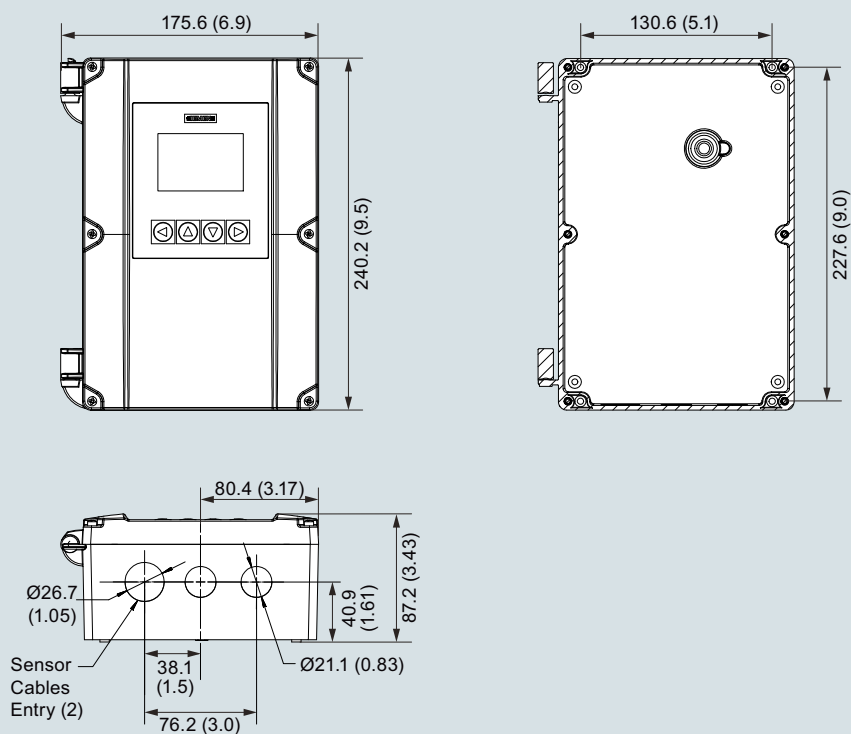

SITRANS FST020 IP65 (NEMA 4X), wall mount enclosure, dimensions in mm (inch)