

Linear Luminaire for Fluorescent Lamps Series ECOLUX METAL L610/1

STAHL

- > Industrial design
- > 2-lamp version:
 - 18 W
 - 36 W
- > Housing made of sheet steel or stainless steel SS304 / SS316L
- > Quick fasteners



16975E00



E2

www.stahl.de



The light fittings of Series ECOLUX METALL L610 can be used for normal lighting, but also as group-supplied or centrally supplied emergency light fitting. The version with stainless steel SS316L metal enclosure is particularly suitable for marine applications.

WebCode L610A

Linear Luminaire for Fluorescent Lamps

Series ECOLUX METAL L610/1

Selection Table

Version	Lamps	Through wiring	Cable glands	Enclosure	Order number	Art. no.	Weight kg
ECOLUX METAL L610	2 x 18 W	without	M25	Sheet Steel	L610/1052-2807-3101	243287	3.600
				Stainless Steel SS316L	L610/1052-2807-3141	243289	3.610
			M20	Sheet Steel	L610/1052-2808-3101	243284	3.600
				Stainless Steel SS316L	L610/1052-2808-3141	243286	3.610
		with	M25	Sheet Steel	L610/1052-2857-3201	243967	3.620
				Stainless Steel SS316L	L610/1052-2857-3441	243971	3.630
			M20	Sheet Steel	L610/1052-2858-3201	243969	3.620
				Stainless Steel SS316L	L610/1052-2858-3441	243973	3.630
	2 x 36 W	without	M25	Sheet Steel	L610/1054-2807-3101	243293	6.100
				Stainless Steel SS316L	L610/1054-2807-3141	243295	6.110
			M20	Sheet Steel	L610/1054-2808-3101	243290	6.100
				Stainless Steel SS316L	L610/1054-2808-3141	243292	6.110
		with	M25	Sheet Steel	L610/1054-2857-3201	243968	6.120
				Stainless Steel SS316L	L610/1054-2857-3441	243972	6.130
			M20	Sheet Steel	L610/1054-2858-3201	243970	6.120
				Stainless Steel SS316L	L610/1054-2858-3441	243974	6.130

Note The light fittings are supplied without tubes. These must be ordered separately.

Technical Data

Electrical data

Ballast	Rated voltage AC	220 ... 240 V 50 / 60 Hz
	Voltage DC during switching on	198 ... 276 V
	Voltage DC during operation	176 ... 276 V
	Rated operational current 2 x 18 W	0.17 A
	Rated operational current 2 x 36 W	0.34 A
	Power factor cos φ	≥ 0.96

Ambient conditions

Operating temperature range	-25 ... +55 °C
-----------------------------	----------------

Mechanical data

Degree of protection	IP66 for ceiling mounting IP65 for wall mounting IP64 when using breather 8162 IP67 (IEC 60598)
Protection class	I (with internal PE connection)
Material	
Enclosure	Sheet steel powder coated Stainless steel SS304 (V2A 1.4301) powder coated, optional brushed Stainless steel SS316L (V4A 1.4404) powder coated, optional brushed
Translucent cover	Polycarbonate
Luminaire locking	Quick locking device, stainless steel
Colour	colour white, similar to RAL 9010
Gasket	Silicon foamed in translucent cover

Linear Luminaire for Fluorescent Lamps

Series ECOLUX METAL L610/1



Technical Data

Mounting / Installation



Cable glands	2x M20/M25 left and right, 1x cable glands and 3 stopping plugs as standard
Connection	Spring clamp terminal up to 4 mm ² 3-pole (2 x L1, 2 x N, 2 x PE) 5-pole (2 x L1, 2 x L2, 2 x L3, 2 x N, 2 x PE) Screw terminal up to 6 mm ² 3-pole (2 x L1, 2 x N, 2 x PE) 5-pole (2 x L1, 2 x L2, 2 x L3, 2 x N, 2 x PE)
Through wiring	option
Assembly	Suitable for wall and ceiling mounting. Mounting holes for screws M8 and elongated holes for screws M6 are available. Observe the assembly drawing.

E2

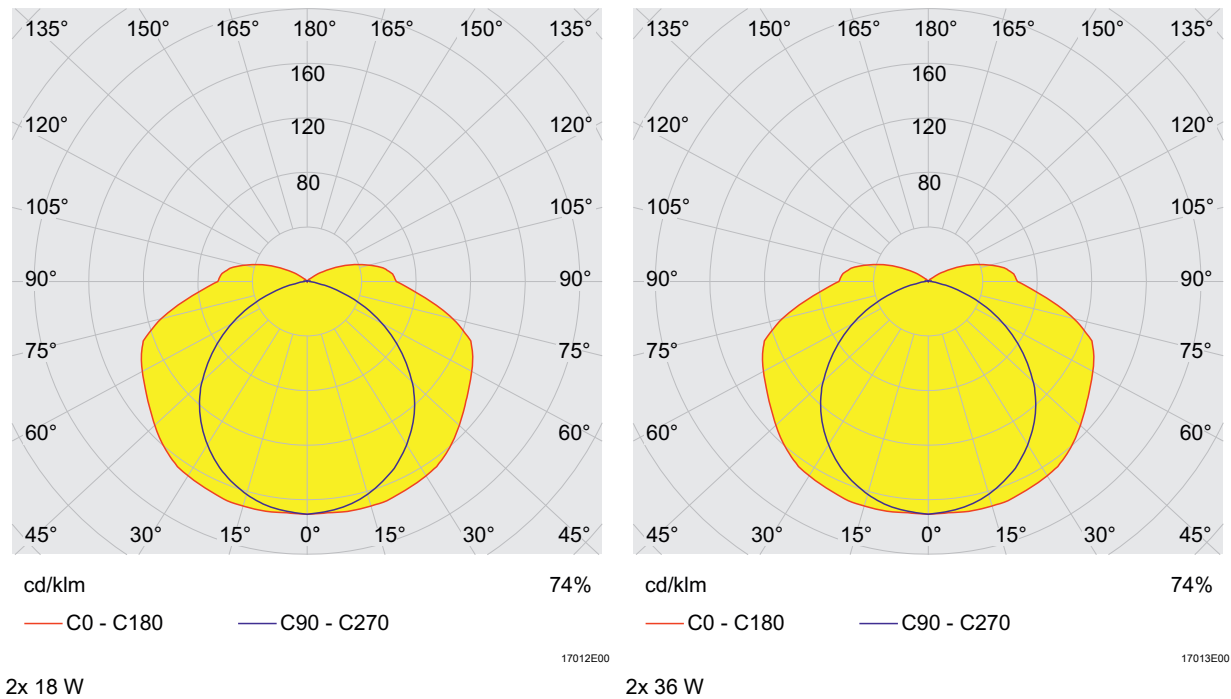
Light Distribution Curves





Accessories and Spare Parts

Designation	Figure	Description	Art. no.	Weight kg
Fluorescent lamp	 04936E00	Two-pin cap \varnothing 26 mm Light colour: universal white Pins made of brass		
		18 W 1350 lm	108952	0.100
		36 W 3350 lm	108951	0.200
Diffuser cover	 05329E00	for light fitting 18 W	124890	0.500
		for light fitting 36 W	124897	0.860
Lamp-holder	 05888E00	Lamp holder for two-pin cap lamps G 13	107275	0.008

Linear Luminaire for Fluorescent Lamps

Series ECOLUX METAL L610/1

Accessories and Spare Parts

Designation	Figure	Description	Art. no.	Weight kg	
Cable gland		02055E00 of moulded material, Series 8161			
		8161/7-M20-1304 4 ... 13 mm ²	1 piece	229917	0.012
		02055E00 8161/7-M20-1304 4 ... 13 mm ²	50 pieces (delivery lot*)	239156	0.600
		8161/7-M25-1707 7 ... 17 mm ²	1 piece	229918	0.020
Stopping plug		of moulded material, Series 8290			
		04840E00 8290/3-M20	1 piece	143522	0.005
		8290/3-M20	100 pieces	143543	0.500
		8290/3-M25 x 1,5	1 pieces	143524	0.007
Breathing gland		for installation in lights; in moulded material; without counter nut			
		05703E00 Thread: M25 x 1.5	1 pc	138573	0.010
		Thread: M25 x 1.5	20 pcs	138576	0.200

Dimensional Drawings (all Dimension in mm [inch]) - Subject to Alterations

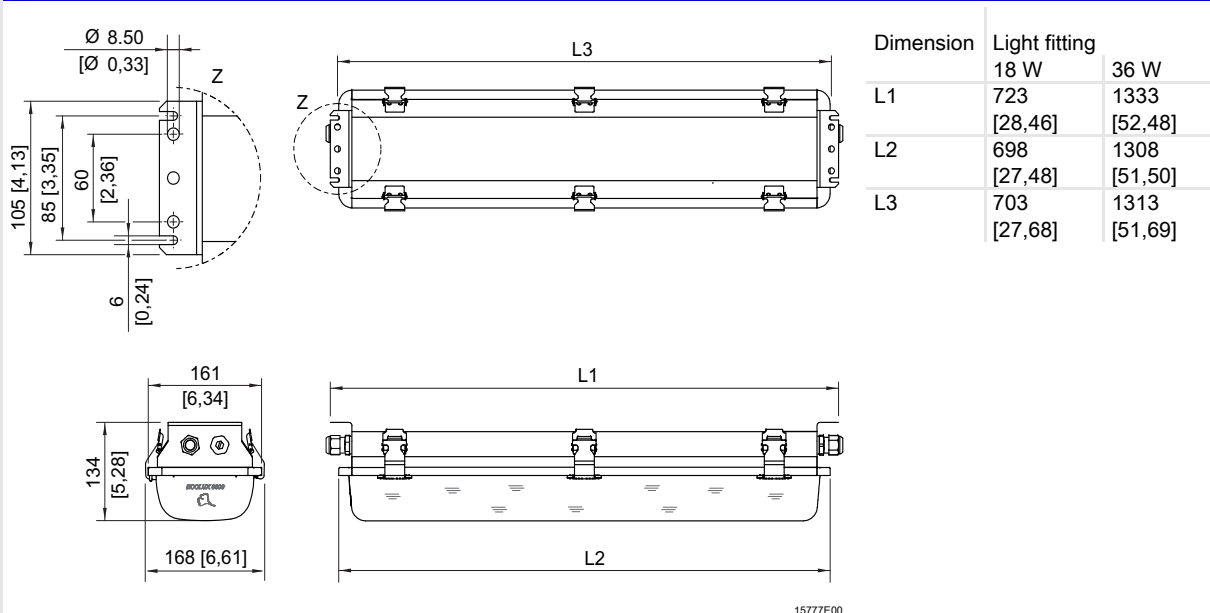

Light Fitting ECOLUX METAL Serie L610, 18 W, 36 W

We reserve the right to make alterations to the technical data, dimensions, weights, designs and products available without notice. The illustrations cannot be considered binding.