

Electronic differential pressure switch with display Model A2G-45

WIKA Datasheet A2G-45

air2guide

Applications

- Electronic differential pressure switch for monitoring the differential pressure of air and other non-inflammable and non-aggressive gases
- Monitoring of air filters, blowers in ventilation ducts
- Control of air and fire shutters and for overpressure monitoring in clean rooms and laboratories

Special Features

- Simple mounting
- Compact and robust design
- LCD display
- Simple setting of the switch point (relay output)
- Output signal 0 ... 10 V



Electronic differential pressure switch model A2G-45

Standard Features

Design

Per 89/336/EEC electromagnetic compatibility and RoHS directive 2002/95/EC

Accuracy class

1.5 % of full span

Measuring ranges

- Option 1: -2 ... +2 InWC (factory set)
(-0.4 ... +0.4 InWC, -1 ... +1 InWC, -1.2 ... +1.2 InWC selectable via jumpers)
- Option 2: 0 ... 10 InWC (factory set)
(0 ... 0.4 InWC, 0 ... 1 InWC, 0 ... 4 InWC selectable via jumpers)

Maximum pressure

100 InWC

Permissible temperature

Ambient: -4 ... +158 °F

Media: +14 ... +122 °F

(+23 ... +122 °F with automatic zero adjustment)

Ingress protection

IP 54 per EN 60529 / IEC 529 (NEMA 3)

Weight

5.2 oz.

Standard version

Process connection

Copper alloy, for 1/8" or 1/4" hose ID

Measuring element

Piezo measuring cell

Zero point adjustment

By pressing the "up" and "down" arrow keys simultaneously

Case/cover

Plastic (ABS)/plastic (PC)

Electrical connection

Cable gland M16 and M20

Screw terminals, max. 1.5 mm²

Output signal

0 ... 10 V, 2-wire, load resistance min. 1 kOhm

Supply voltage

AC 24 V \pm 10 % or DC 21 ... 35 V

Current supply

35 mA + switch (7 mA each) + instrument with automatic zero adjustment (20 mA)

+ 0 ... 10 V output (10 mA), max. 80 mA

Long-term stability

$\leq \pm 0.03$ lnWC

$\leq \pm 0.004$ lnWC with automatic zero adjustment (option)

Connection diagram

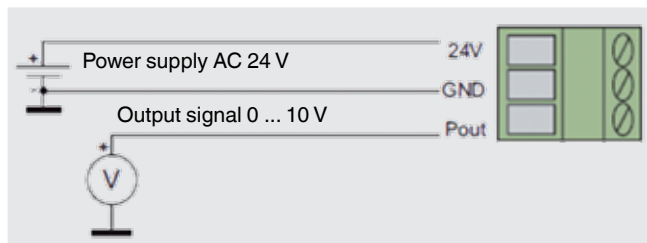

If the voltages being switched via the relays are not in accordance with SELV, then the power supply and signal/control cables of the relays should be installed so that they are separated. A separate cable entry is available for both.



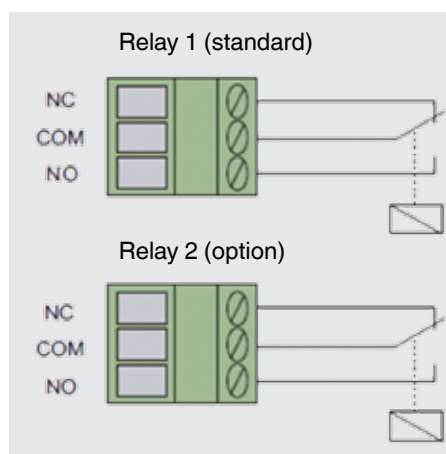
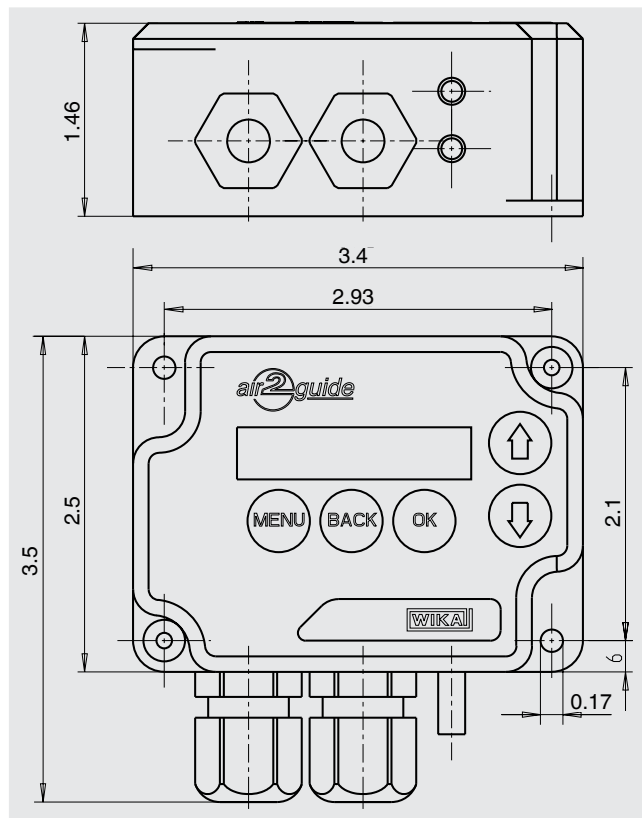

Options

- Automatic zero adjustment
- Two switching outputs

Dimensions in inches



Buttons for setting the individual functions

Key	Function
	To access the menu, press the "MENU" button for approx. 3 seconds.
	To exit the menu, press the "BACK" button.
	To open an individual menu point, and to accept the changes, press the "OK" button.
 	These buttons enable you to scroll within the menu.

Menu selection and initialisation instructions for installation

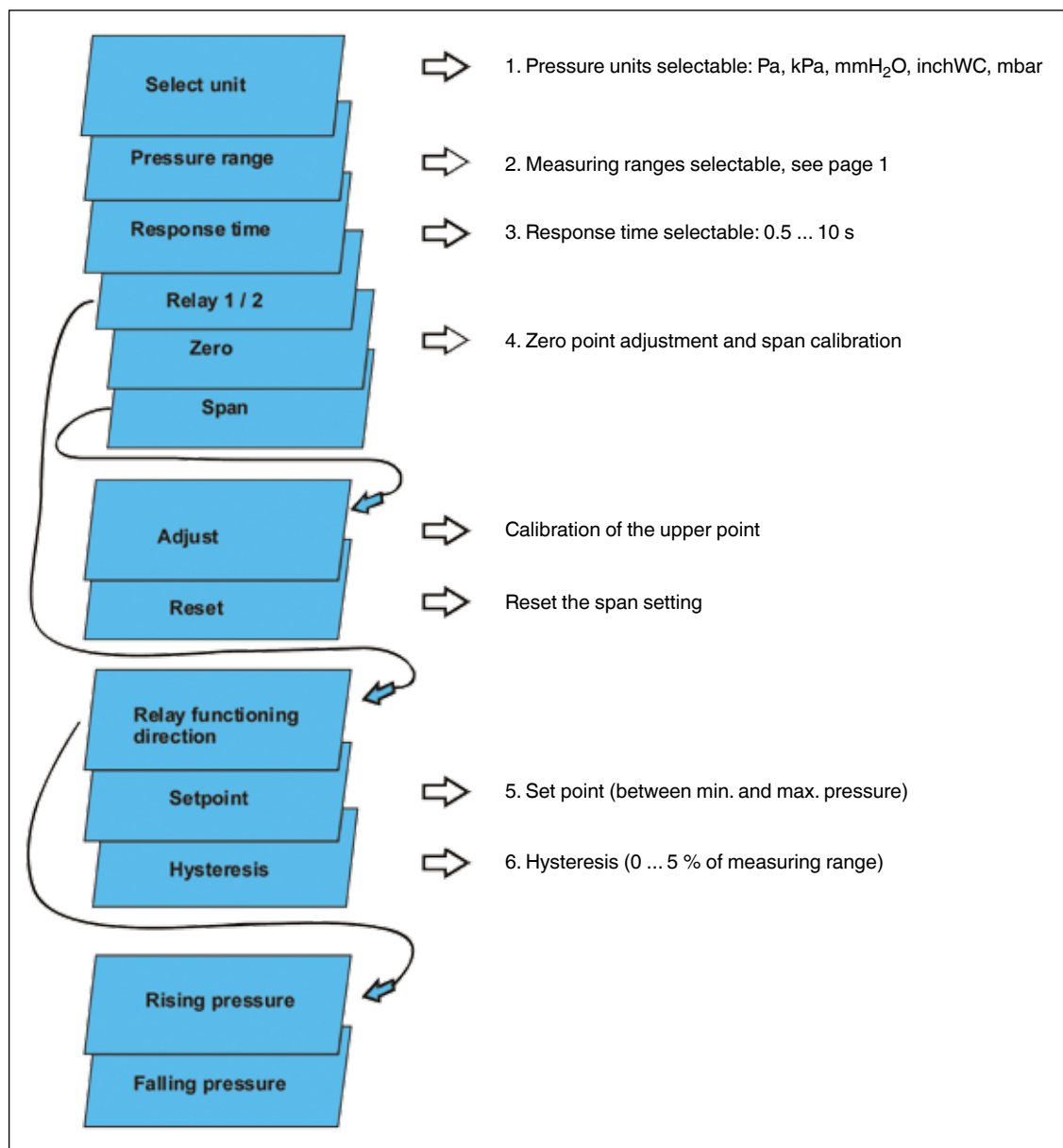

Zero point adjustment

Attention!

Connect the voltage supply one hour before making the zero point adjustment.

- Remove both hoses from the pressure connections \oplus and \ominus .
- Press both the "up" and "down" buttons simultaneously, or select "Zero" in the setting menu:
⇒ the green LED switches off and "Zero" is shown in the display.
- Wait until the green LED switches back on, then reconnect the \oplus and \ominus pressure connections.

4. In normal operation, we recommend that a zero point adjustment is carried out every 12 months.

Span calibration

Attention!

Connect the voltage supply one hour before making the span calibration.

A reference pressure measuring instrument is needed for the span setting.

The span should not be set without pressure being present. If the span is set with either no test pressure, or too low of a pressure, the instrument will lose its accuracy and no longer provides correctly measured values.

If this should occur, select the menu point "Span" and then select "Reset", in order to reset the span setting.

Set the span in the following sequence:

1. Carry out a zero point calibration
2. Connect the pressure connections
3. Select "Span" in the menu and then select "Adjust"
4. Using both the "up" and "down" arrow buttons, set the relevant value for the display or the 0 ... 10 V output, so that it matches the reference pressure instrument's value
5. Confirm the setting by pressing the "OK" button

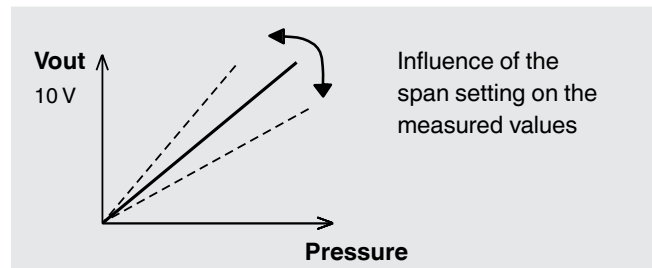

Ordering information

Model / Measuring range / Options

