

PRESSURE FILTER
Series **LF 1211-10011** **145 PSI**

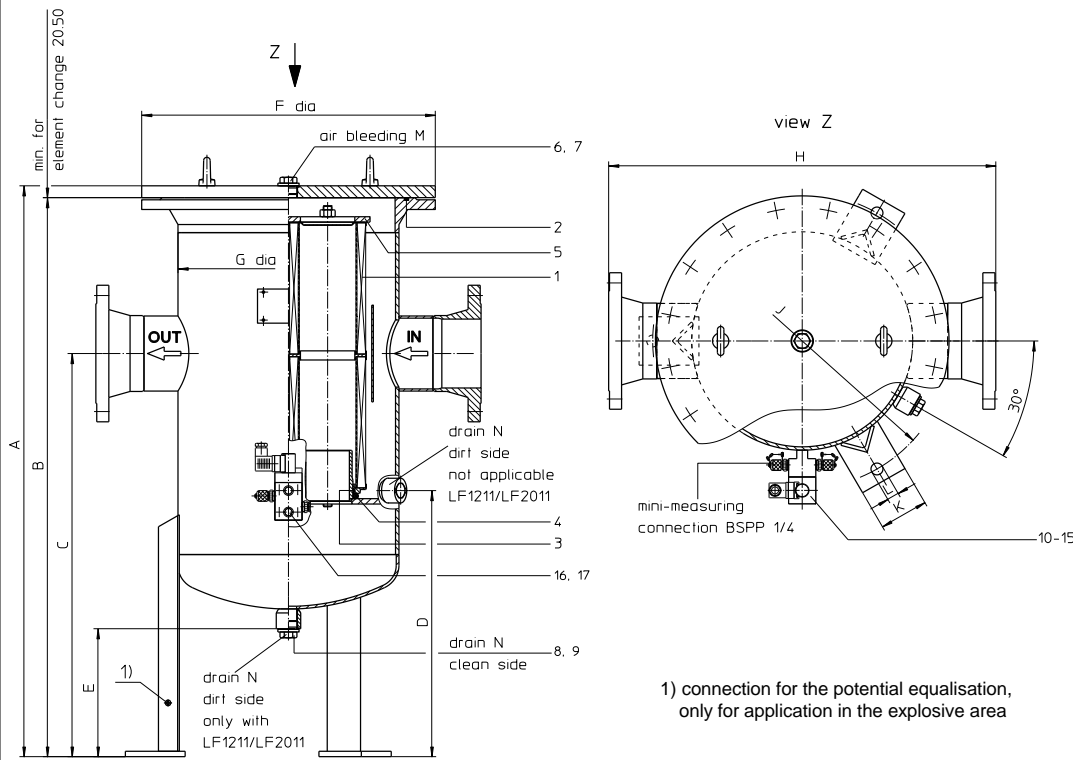

3. Dimensions: inch

type	conn. ANSI	A	B	C	D	E	F	G	H	J	K	L	M	N	weight lbs.	volume tank
LF 1211	2"	41.42	40.47	15.75	-	7.40	13.38	8.62	17.95	12.99	2.76	.71	1/2 BSPP	1 BSPP	132	6.8 Gal
	2 1/2"	42.20	41.22													7.1 Gal
	3"	41.42	40.47													6.8 Gal
	4"	44.40	43.46													7.6 Gal
LF 2011	2 1/2"	43.03	42.00	16.73	-	7.32	15.55	10.75	21.96	14.96	2.76	.71	1 BSPP	1 BSPP	242	11.5 Gal
	3"	43.77	42.75													11.7 Gal
	4"	43.30	42.28													11.5 Gal
	5"	46.77	45.74													12.6 Gal
LF 2411	2 1/2"	40.00	38.98	27.56	17.52	7.20	17.51	12.46	25.98	17.72	2.76	.71	1 BSPP	1 BSPP	286	14.5 Gal
	3"															
	4"															
LF 3611	3"	41.96	40.94	29.53	19.49	9.37	22.24	15.98	28.03	21.65	3.54	.87	1 BSPP	1 BSPP	572	23.7 Gal
	4"															
	5"															
LF 4811/6011	4"	43.62	42.52	31.50	21.06	9.13	26.37	20.00	34.48	25.95	3.54	.87	1 BSPP	1 BSPP	682	38.3 Gal
	5"															
	6"															
LF 10011	5"	45.11	43.70	31.50	22.44	11.14	35.23	27.99	41.73	35.43	4.72	.87	1 1/2 BSPP	1 1/2 BSPP	1232	74.7 Gal
	6"															
	8"															
	10"															

EDV 08/12

1. Type index:

1.1. Complete filter: (ordering example)

LF. 2011. 10VG. 10. E. P. -. FA11. 9. -. AE

1	2	3	4	5	6	7	8	9	10	11
---	---	---	---	---	---	---	---	---	----	----

- 1) **series:**
LF = in-line filter
- 2) **nominal size:** 1211, 2011, 2411, 3611, 4811, 6011, 10011
- 3) **filter material and filter fineness:**
80 G = 80 µm, 40 G = 40 µm, 25 G = 25 µm stainless steel wire mesh,
25 VG = 20 µm_(c), 16 VG = 15 µm_(c), 10 VG = 10 µm_(c), 6 VG = 7 µm_(c), 3 VG = 5 µm_(c) Interpor fleece (glass fiber)
25 API = 20 µm, 10 API = 10 µm Interpor fleece (glass fiber) according to API
- 4) **resistance of pressure difference for filter element:**
10 = Δp 145 PSI
- 5) **filter element design:**
E = without by-pass valve; S = with by-pass valve Δp 29 PSI
- 6) **sealing material:**
P = Nitrile (NBR); V = Viton (FPM)
- 7) **filter element specification:** (see catalog)
- = standard
VA = stainless steel
IS06 = see sheet-no. 31601
- 8) **connection:**
FA11 = ANSI-flange CLASS 150 PSI sealing surface rough grind 1600-3600 µin
FA12 = ANSI-flange CLASS 150 PSI, sealing surface rough grind < 640 µin
- 9) **connection size:**

DN	filter nominal size						
8 = 2"	1211						
9 = 2 1/2"	1211	2011	2411				
A = 3"	1211	2011	2411	3611			
B = 4"	1211	2011	2411	3611	4811	6011	
C = 5"		2011	2411	3611	4811	6011	10011
D = 6"				3611	4811	6011	10011
E = 8"					4811	6011	10011
F = 10"							10011

- 10) **filter housing specification:** (see catalog)
- = standard
IS06 = see sheet-no. 31605
- 11) **clogging indicator or clogging sensor:**
- = without
AE = visual-electrical, see sheet-no.1609
OP = visual, see sheet-no.1628; VS1 = electronical, see sheet-no.1607
OE = visual-electrical, see sheet-no 1628; VS2 = electronical, see sheet-no.1608

1.2. Filter element: (ordering example)

01E. 2001. 10VG. 10. E. P. -

1	2	3	4	5	6	7
---	---	---	---	---	---	---

- 1) **series:**
01E. = filter element according to company standard
- 2) **nominal size:** 1201, 2001
- 3) - 7 see type index-complete filter

2. Accessories:

- measure-and bleeder -connections, see sheet-no. 1650
 - evacuation- and bleeder-connections, see sheet-no. 1651
 - counter flanges, ANSI-flange 150 PSI
 - lifting mechanism, see sheet-no. 1661
- Changes of measures and design are subject to alteration!

4. Spare parts:

4.1. Depending on different series:

item	designation	qty.	dimension and article-no. LF 1211	dimension and article-no. LF 2011	qty.	dimension and article-no. LF 2411	qty.	dimension and article-no. LF 3611	qty.	dimension and article-no. LF 4811	qty.	dimension and article-no. LF 6011	dimension and article-no. LF 10011	
1	filter element	1	01E.1201	01E.2001	2	01E.1201	3	01E.1201	4	01E.1201	3	01E.2001	5	01E.2001
2	O-ring	1	225 x 5	275 x 5	1	330 x 5	1	429 x 6	1	516 x 6	1	516 x 6	722 x 8	
			308652 (NBR) 311473 (FPM)	307414 (NBR) 310288 (FPM)		303080 (NBR) 310275 (FPM)		308659 (NBR) 310273 (FPM)		301962 (NBR) 311474 (FPM)		301962 (NBR) 311474 (FPM)	308145 (NBR) 311805 (FPM)	
3	O-ring	1	93 x 5	135 x 5	2	93 x 5	3	93 x 5	4	93 x 5	3	135 x 5	135 x 5	
			307588 (NBR) 307589 (FPM)	306016 (NBR) 307045 (FPM)		307588 (NBR) 307589 (FPM)		307588 (NBR) 307589 (FPM)		307588 (NBR) 307589 (FPM)		306016 (NBR) 307045 (FPM)	306016 (NBR) 307045 (FPM)	
4	O-ring	1	85 x 10	125 x 10	2	85 x 10	3	85 x 10	4	85 x 10	3	125 x 10	125 x 10	
			304386 (NBR) 304541 (FPM)	304388 (NBR) 306006 (FPM)		304386 (NBR) 304541 (FPM)		304386 (NBR) 304541 (FPM)		304386 (NBR) 304541 (FPM)		306016 (NBR) 306006 (FPM)	304388 (NBR) 306006 (FPM)	
5	spring	1	304414		-	-	-	-	-	-	-	-	-	
	pressure plate	-	-		1	309851	1	313116	1	314718	1	313335	1	313062
6	screw plug	1	½ BSPP	1 BSPP	1	1 BSPP		1	1 BSPP		1	1 ½ BSPP		
			309730	309732		309732	309732		318556					
7	gasket	1	A 22 x 27	A 33 x 39	1	A 33 x 39		1	A 48 x 55		1	A 48 x 55		
			305564	308257		308257	309764							
8	screw plug	1	1 BSPP	1 BSPP	2	1 BSPP		2	1 ½ BSPP		2	1 ½ BSPP		
			309732	309732		309732	318556							
9	gasket	1	A 33 x 39	A 33 x 39	2	A 33 x 39		2	A 48 x 55		2	A 48 x 55		
			308257	308257		308257	309764							

4.2. Depending on the series:

item	qty.	designation	dimension	article-no.
10	1	clogging indicator, visual	OP	see sheet-no. 1628
11	1	clogging indicator, visual-electrical	OE	see sheet-no. 1628
12	1	clogging indicator, visual-electrical	AE	see sheet-no. 1609
13	1	clogging sensor, electrical	VS1	see sheet-no. 1607
14	1	clogging sensor, electrical	VS2	see sheet-no. 1608
15	2	O-ring	14 x 2	304342 (NBR) 304722 (FPM)
16	2	screw plug	½ BSPP	309734
17	2	gasket	A 14 x 18	306330

5. Description:

In-line filters of the series LF 1211-10011 are suitable for a working pressure up to 145 PSI.

Pressure peaks can be absorbed with a sufficient margin of safety.

The filter is in-line mounted. Inlet and outlet are on the same level. The filters can be installed as suction-filter, pressure-filter or return-line filter.

The filter element consist of star-shaped, pleated filter material which is supported on the inside by a perforated core tube and is bonded to the end caps with a high-quality adhesive. The flow direction is from outside to the inside. The particles are hold back on the outside. For cleaning (see special leaflet 21070-4 resp. 39448-4) the mesh element respectively to change the glass fiber element remove the cover and take out the element.

Filter finer than 40 µm should use throw-away elements made of paper or Interpor fleece (glass fiber). Filter elements as fine as 5 µm are available; finer filter elements on request.

Internormen Product Line filter elements are known as elements with a high intrinsic stability and an excellent filtration capability, a high dirt-retaining capacity and a long service life.

Internormen Product Line filter are suitable for all petroleum based fluids, HW-emulsions, most synthetic hydraulic fluids and lubrication oils.

Approvals according to TÜV, and the mayor „Shipyard Classification Societies“ D.N.V.; B.V.; G.L.; L.R.S.; R.I.N.A.; A.B.S.; P.R.S.;USS.R.S. and others are possible.

6. Technical data:

temperature range:	+14°F to +176°F (for a short time +212°F)
operating medium:	mineral oil, other media on request
max. operating pressure:	145 PSI
test pressure:	208 PSI
connection system:	ANSI-flange connection CLASS 150 PSI
housing material:	C-steel
sealing material:	Nitrile (NBR) or Viton (FPM), other materials on request
installation position:	vertical
mini-measuring connection:	½ BSPP

Classified under the Pressure Equipment Directive 97/23/EC for mineral oil (fluid group 2), Article 3, Para. 3.

Classified under ATEX Directive 94/9/EC according to specific application (see questionnaire sheet-no. 34279-4).

US 1127 C

7. Symbols:

without indicator

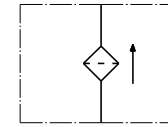

with electrical indicator

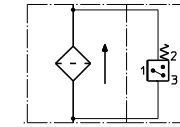

with visual - electrical indicator

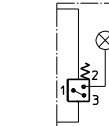

with visual - electrical indicator

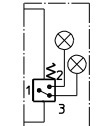

with visual indicator

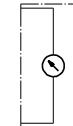

with visual - electrical indicator

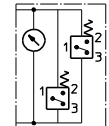

with electronic clogging sensor

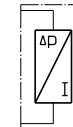

with electronic clogging sensor

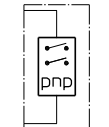

8. Pressure drop flow curves:

Precise flow rates see 'Interactive Product Specifier', respectively Δp-curves; depending on filter fineness and viscosity.

9. Test methods:

Filter elements are tested according to the following ISO standards:

ISO 2941	Verification of collapse/burst resistance
ISO 2942	Verification of fabrication integrity
ISO 2943	Verification of material compatibility with fluids
ISO 3723	Method for end load test
ISO 3724	Verification of flow fatigue characteristics
ISO 3968	Evaluation of pressure drop versus flow characteristics
ISO 16889	Multi-pass method for evaluating filtration performance